



THE FIGHTER COLLECTION



Eagle Dynamics

A-10C WARTHOG



DCS A-10C II Tank Killer

Flight Manual

CONTENT

INTRODUCTION	16
A-10 HISTORY	19
Identifying the Need.....	19
The A-X Competition	20
Production	23
A-10 Evolution	28
A-10 Missions.....	31
Operational Use	34
Operation Desert Storm.....	42
Operation Allied Force.....	45
Current Operations in Iraq and Afghanistan.....	46
GENERAL DESIGN	49
Fuselage and Wings	50
Fuselage	52
Wings	52
Control Surfaces.....	54
Elevators	55
Ailerons.....	56
Rudders	57
Flight Control Systems (FCS).....	57
Stability Augmentation System (SAS)	57
Manual Reversion Flight Control System (MRFCS)	58
Enhanced Attitude Control System (EAC).....	58
Engines and APU.....	59
Engines	59
Auxiliary Power Unit (APU)	61

Avionics Systems.....	61
Pilot Survival and System Redundancy.....	63
Radio Equipment.....	64
Countermeasures Systems.....	65
A-10C STORES	69
A/A 49E / GAU-8/A.....	69
A-10C Station Racks.....	71
2.75-inch Hydra 70 Unguided Folding Fin Aerial Rockets.....	73
Unguided Bombs.....	76
General Purpose Bombs	76
Cluster Bombs	79
General Purpose Training Bombs	81
Illumination Flares.....	83
Laser Guided Bombs.....	86
Inertially Aided Munitions (IAM).....	88
AGM-65 Maverick	93
Advanced Precision Kill Weapon System	97
AIM-9M / CATM-9M Sidewinder.....	98
TK600 External Fuel Tanks	100
AN/AAQ-28 Litening AT Targeting Pod.....	101
MXU-648 Travel Pod.....	102
General and Performance Characteristics.....	103
COCKPIT CONTROLS.....	105
Instrument Panels Overview	105
Control Stick	106
Throttles.....	111
Front Dash.....	112
Left Front Dash	113

Left Engine "T-Handle" Fire Extinguisher Discharge Select.....	114
Radar Warning Receiver (RWR) Display.....	115
Airspeed Indicator.....	116
Standby Attitude Indicator (SAI).....	117
UHF Frequency Repeater.....	118
Angle of Attack Indicator.....	118
Digital Clock.....	119
Emergency Jettison Button.....	120
Left Multifunction Color Display (MFCD).....	121
Landing Gear and Flap Control Panel.....	125
Armament HUD Control Panel (AHCP).....	129
Heading Attitude Reference (HARS) Fast Erect Button.....	133
Gun and Nose Wheel Steering (NWS) Lights.....	134
Center Front Dash.....	135
APU "T Handle" Fire Extinguisher Discharge Select.....	136
Countermeasures Set Control (CMSC).....	136
Right Dash.....	143
Fire Extinguisher Discharge.....	144
Right Multifunction Color Display (MFCD).....	144
Fuel Quantity and Hydraulic Indicator Panel.....	146
RIGHT Engine "T Handle" Fire Extinguisher Discharge Select.....	147
Marker and Canopy Lights.....	148
Vertical Velocity Indicator (VVI).....	148
Altimeter.....	149
Engine Monitoring Instruments (EMI).....	150
Heads Up Display Area Above Dash.....	152
Standby Compass.....	153
Air Refuel Status Lights.....	153

Accelerometer (G-meter).....	154
Angle of Attack Indexer	155
Left Console.....	156
Fuel System Control Panel	158
Throttles Panel	160
LASTE Control Panel	163
AN/ARC-186(V) Radio Control Panel.....	167
AN/ARC-164 UHF Radio Control Panel	168
AN/ARC-186(V) VHF FM Radio 2 Control Panel.....	171
KY-58 Secure Voice Control Panel	173
Emergency Brake System	174
Auxiliary Lighting Control Panel.....	175
Stability Augmentation System (SAS) Panel	176
Identify Friend or Foe (IFF) Panel	178
Emergency Flight Control Panel	180
Intercom Control Panel	182
Stall Warning Control Panel	183
Right Console.....	185
Cockpit Canopy Switch and Canopy Ejection Handle.....	186
Electrical Power Panel	187
Environment System Panel	189
Lighting Control Panel	191
Caution Light Panel	195
TACAN Operation and Control Panel.....	198
ILS Control Panel and ILS Operation	199
Heading and Attitude Reference Systems (HARS) Control Panel.....	200
Helmet Mounted Cueing System (HMCS) Control Panel	201
Embedded GPS/INS (EGI) Navigation System	201

Auxiliary Avionics Panel (AAP).....	203
Control Display Unit (CDU) and Pages	205
UP FRONT CONTROLLER (UFC)	303
MULTIFUNCTION COLOR DISPLAY (MFCD) PAGES.....	309
Heads Up Display (HUD).....	426
IFFCC TEST Menu	426
Weapon and Navigation HUD Modes	429
SPI and Hookship Symbols.....	466
HUD Messages.....	469
Helmet Mounted Cueing System.....	473
HMD Symbology	473
Configuring the HMCS	479
Using the HMCS.....	481
HMCS HOTAS Controls	482
Understanding SOI and SPI	483
Sensor of Interest (SOI).....	483
Sensor Point of Interest (SPI)	487
Countermeasure Systems	491
Countermeasure Signal Processor (CMSP) Panel	491
Activate a Program	496
Edit a Program.....	496
Countermeasures Set Control (CMSC)	497
ALR-69(V) Radar Warning Receiver (RWR)	500
AIRCRAFT STARTUP PROCEDURES.....	504
Flight Preparation.....	504
Left Console	505
Front Dash	510
Right Console	513

Start.....	518
Electrical Power Start and APU.....	518
Radio Set Up	523
Set Up Auxiliary Avionics Panel (AAP).....	526
Left Engine Start.....	527
Right Engine Start.....	528
Trim Check.....	529
Test Pitot Tube Heating.....	530
Enable IFFCC.....	531
Enable CICU	532
Turn on the MFCDs and Load Data	532
Load Flight Plan	533
Select TAD Page	535
Enable the Targeting Pod (TGP).....	536
Select STAT Page.....	537
Select DSMS Page.....	538
Set Up Countermeasure Systems	539
EGI CDU Set Up.....	540
Enable Stability Augmentation System (SAS)	542
Close Canopy.....	544
NAVIGATION.....	546
Navigation Mode Select Panel (NMSP)	546
Heading Attitude Reference System (HARS) Navigation	547
HARS Fast Erect.....	548
HARS Modes of Operation	548
Embedded GPS INS (EGI) Navigation	549
Selecting a Waypoint.....	551
Creating a New Waypoint.....	552

UTM and MGRS Coordinates Explained	554
Entering UTM Data as New Waypoint	555
Set a Waypoint as a Steerpoint	556
Creating / Reassigning an Anchor Point	559
Setting a Markpoint	562
Create a Flight Plan	563
Removing Waypoints from a Flight Plan	567
Setting Desired Time on Target (DTOT)	569
TACAN (TCN) Navigation	570
ILS Navigation	573
FLIGHT FUNDAMENTALS.....	576
Aerodynamic Forces	576
Air Speeds	577
Total Velocity Vector (TVV)	578
Angle of Attack (AoA)	578
Turn Rate and Radius of Turn	580
Turn Rate	581
Sustained and Instantaneous Turns.....	583
Energy Management	583
FLIGHT SCHOOL.....	586
General Requirements	586
Taxi Preparation and Taxi	586
Runway Lineup Checks	587
Normal Takeoff	587
Crosswind Takeoff.....	588
Climb Out	588
Basic Maneuvers	589
Changing Airspeed	589

Changing Altitude	591
Changing Heading.....	593
Trimming the Aircraft	595
Aerial Refueling (Quick Flow)	596
Preparation.....	596
Pre-Contact	597
Contact	597
Disconnect	598
Landing Preparation	599
Landing Traffic Pattern	600
TACAN Approach	600
ILS Approach.....	602
Ground Control Approach (GCA)	603
Circling Landing Approach	603
Straight-In Landing Approach	606
Landing.....	606
Aircraft Shut Down	607
COMBAT EMPLOYMENT.....	610
Target Area Ingress Preparations	610
Set Up Countermeasures	610
Turn Off Exterior Lights.....	611
Armament HUD Control Panel (AHCP) Set Up	612
Review Digital Stores Management System (DSMS) Pages.....	613
Hook Tactical Awareness Display (TAD) Objects	616
Targeting Pod (TGP) Set Up	617
Gun Employment	625
Set Up IFFCC 30 MM Menu.....	625
DSMS Status Page GUNS Indications.....	628

Gunsights	630
Gun Use	632
Unguided Rocket Employment	634
DSMS Rocket Pages	634
Unguided Rocket CCIP Use	637
Unguided Rocket CCRP Use	640
Advanced Precision Kill Weapon System (APKWS)	641
Unguided Bomb Employment	644
Set Up IFFCC Menu	644
DSMS Unguided Bomb Pages	644
CCIP Bombing Use	650
CCRP Bombing Use	655
Illumination Flare Employment	658
DSMS Illumination Flare Pages	658
Illumination Flare Use	660
Laser-Guided Bomb Employment	663
AHCP Configuration	664
Laser Designate Target	665
DSMS Laser Guided Bomb Pages	668
Laser Guided Bomb Use	671
IAM Bomb Employment	675
DSMS IAM Bomb Pages	675
IAM Bomb Use	678
GBU-54A Laser-JDAM (LJDAM)	679
Engagement	683
AGM-65 E/O Maverick Employment	684
DSMS and MFCD Maverick Pages	684
Maverick Use	687

AGM-65L Laser-Guided Maverick	693
AGM-65L DSMS Status Page	693
DSMS INVENTORY Page.....	694
Laser-Maverick Video	695
Advanced Precision Kill Weapon System (APKWS)	698
DSMS.....	698
HUD.....	700
Engagement.....	702
Air-to-Air Employment	702
DSMS Air-to-Air Status Page	702
Using the Targeting Pod for Air-to-Air	703
AIM/CATM-9M and 30 MM Cannon Use	705
EMERGENCY PROCEDURES	709
Caution Light Panel Indications	709
Flight and Flight Control Emergencies.....	717
Flap Asymmetry.....	717
Speed Brake Asymmetry or Failure.....	717
Aileron/Elevator Jam	718
Hydraulic Failure.....	718
Trim Failure.....	719
Out-of-Control Recovery.....	719
Hypoxia.....	719
Manual Reversion Landing	720
Engine, APU, and Fuel Emergencies	720
Engine Fire.....	720
APU Fire.....	720
Single Engine Restart	721
Engine Start after a Failed Start.....	721

APU Over-temperature	722
Engine Oil Malfunction.....	722
Main Fuel Boost Pump Failure.....	722
Wing Fuel Boost Pump Failure	722
Fuel Pressure Low or Fuel Leak.....	723
Emergency Landings and Exiting	723
Single Engine Landing	723
Flameout Landing	724
Landing Gear Extension Failure.....	725
No Gear Down or Partial Gear Down Landings	725
Ejection.....	726
CHECKLISTS.....	728
Aircraft Startup Preparation	728
Aircraft Startup	733
Electrical Startup.....	733
APU Startup.....	734
Engines Startup	735
Pre-Flight Checks and Set Up	737
Final Checks and Taxi.....	738
Engine Run Up Checks.....	740
Takeoff.....	740
Embedded GPS INS (EGI) Navigation	741
Radio ADF Navigation	745
Countermeasure Panel Programming.....	746
Targeting Pod	748
Weapon Selection and Arming	749
Hung IAM Station.....	751
Weapon Delivery.....	751

Aerial Refueling	758
Landing Preparations.....	760
Landing Approach	760
Aircraft Shut Down	763
RADIO COMMUNICATIONS.....	767
Top Level Recipient List	768
F1 Wingman	768
F1 Navigation.....	769
F2 Engage.....	769
F3 Engage With... ..	770
F4 Maneuvers... ..	771
F5 Rejoin Formation.....	772
F6 Out	772
F2 Flight	772
F1 Navigation.....	772
F2 Engage.....	773
F3 Engage With... ..	773
F4 Maneuvers... ..	773
F5 Formation	774
F6 Rejoin Formation.....	781
F7 Fence In	781
F8 Fence Out.....	781
F3 Second Element.....	781
F1 Navigation.....	781
F2 Engage.....	782
F3 Engage with... ..	782
F4 Maneuvers... ..	782
F5 Rejoin Formation.....	783

F6 Out	783
Flight Member Responses	783
F4 JTAC.....	784
JTAC Engagement Flow.....	784
F5 ATC	788
ATC VHF AM Contact Frequencies	788
Parking Ramp Start.....	789
Runway and Air Start	789
F6 Ground Crew.....	790
F7 AWACS	790
F9 Tanker	791
Radio Frequencies	791
.....	793
SUPPLEMENTS	794
Morse Code Alphabet	794
Aerodrome Data.....	799
Acronyms	801
CREDITS	808
Eagle Dynamics Team	808
Management	808
Programmers.....	808
Artists and Sound	809
Quality Assurance	810
Science Support.....	810
IT and Customer Support	810
Campaigns	811
Missions	811
Training	811

Subject Matter Experts (SME)	811
Third Parties	812
Voiceover Actors	812
Tester Staff	812

INTRODUCTION

DCS: A-10C II Tank Killer is the follow-on to the renowned DCS: A-10C Warthog, and it brings many improvements and new additions like the latest weapons, a helmet-mounted sight, and new graphics.

The A-10C is the premier Close Air Support (CAS) aircraft of the United States, and it saw extensive use in Iraq and Afghanistan. Tank Killer brings you the most realistic PC simulation of the A-10C that includes the accurately simulated flight dynamics, avionics, sensors, and weapon systems. You also have the option to play Tank Killer in "Game" mode for a casual game experience. Fly missions against and with a wide array of air, land, and sea forces. Create your own missions and campaigns with the included Mission and Campaign Editor and fly with and against friends online using the included online game browser.

The A-10C is most noted for its powerful 30mm rotary cannon, durability and pilot protection, long endurance times, and a massive arsenal of weapons that includes guided and unguided bombs, rockets, guided-missiles, guided-rockets, and more. Be the bane of every hostile tank commander.

Get your Brrrrrrrrt on!

Key features:

- A-10C II adds new weapons that include the Advanced Precision Kill Weapons System (APKWS), AGM-65L laser-Maverick, and GBU-54 laser-guided JDAM.
- New cockpit with options for factory-fresh or wear-and-tear textures.
- "Scorpion" Helmet-Mounted Integrated Cueing System (HMCS).
- ARC-210 radio (coming soon).
- Updated external model with improved textures and materials.
- Fly the A-10C "Warthog" in either realistic or game modes.
- Fly missions in either the Black Sea region or one of the many DLC maps like the Persian Gulf, Syria, and more.
- Multiplayer cooperative and head-to-head.
- Feature-rich Mission and Campaign editors allow user created content.
- The most realistic flight dynamics ever done for a PC simulation.
- Huge array of land, air, and sea units to flight along and against.
- Fully interactive Forward Air Controller (FAC) that helps you find targets.

Sincerely,
The DCS: A-10C II Tank Killer Team
30 September 2020

A-10 HISTORY

OR USAF



A-10 HISTORY

Identifying the Need

The need for the A-10 germinated from the experience of U.S. forces in the Vietnam War. While fast jets like the F-100, F-4 and F-5 could provide Close Air Support (CAS) to troops in emergency situations, their lack of loiter time, high speeds, and weapon delivery inaccuracy proved problematic and an expensive solution. On the other hand, slower aircraft like the U-10 and OV-10 lacked the firepower punch needed. This criticism resulted in charges that the U.S. Air Force did not take close air support seriously and a few high-level service members sought a specialized attack aircraft to remedy this.

The A-1 Skyraider was used to fill this CAS and Combat Search and Rescue (CSAR) role, and its ruggedness, large weapon loads and loiter capability proved to be a success in Southeast Asia. However, it was not deemed survivable enough in a European battlefield scenario.



Figure 1. A-1D Skyraider

During the Vietnam War, the primary threat to CAS mission aircraft was small arms, surface-to-air missiles, and low-level anti-aircraft gunfire. This resulted in a desire for a much more survivable aircraft operating in the CAS environment. The primary environment was still considered Europe at the time, and such an aircraft would need to be survivable operating over Warsaw Pact forces with an extensive array of air defense weaponry.

In addition to the then current fast and slow Air Force attack aircraft, CAS supporting UH-1 and AH-1 gunships did not have the capability to effectively engage enemy armor forces in a feared mechanized Soviet thrust through Western Europe.

Given these items, the Air Force was looking for the following in a replacement for the A-1:

- Rugged and survivable
- Long-loiter capability
- Ability to carry large weapon loads including anti-armor
- Excellent slow speed agility
- Relatively short takeoff and landing rolls

Given the projected dense Warsaw Pact Integrated Air Defense System (IADS) threat, it was also determined that the flight profile of this aircraft would need to be very near and over the battlefield in order to maximize the use of terrain masking. This led to the requirement focusing on low- to mid-altitude operations at the exclusion of high-altitude flight profiles.

The A-X Competition

In June 1966 the Attack Experimental (A-X) program was launched and the requirement issued in September of the same year. The Request for Proposal (RFP) was issued by the Air Force to 21 defense contractors on March 6, 1967. By 1969, the characteristics of a target weight of 35,000 lbs, \$1 million per aircraft, and using twin high-bypass fanjets was determined. The performance requirements were set as follows:

- Turbofans generating between 31.1 and 44.5 kN
- Combat mission radius of 250 nm
- Two-hour mission loiter time at max mission radius with 9,500 lbs. payload
- 4,000 ft takeoff distance
- Highly maneuverable below 1,000 ft
- Easy to maintain at Forward Operating Bases (FOB)
- Low cost
- Ability to use integrated 30 mm cannon to destroy main battle tanks

- Use of off-the-shelf hardware whenever possible to reduce costs

Moving away from the earlier fixed-price contract, it was decided to pursue a Fly-Before-Buy policy when choosing the A-X. As such, competitive RFP contracts were issued to 12 companies on May 7, 1970 with the intent to purchase 600 aircraft at a price of \$1.4 million each (fly away cost). Of the 12 companies, Northrop and Fairchild Republic were selected as the winners of the prototype competition on December 18, 1970. Each company would build two prototypes. The Northrop entry would be designated the YA-9 and the Fairchild Republic would be designated the YA-10.



Figure 2. YA-10A



Figure 3. YA-9A

At the hands of test pilot Howard "Sam" Nelson, the YA-10 made its maiden flight from Edwards AFB on May 10, 1972. The YA-10A was initially fitted with an M61A1 20 mm cannon that would later be replaced in production aircraft with the GAU-8/A 30 mm cannon.

The competition between the two prototypes lasted between October 10, 1972 and December 9, 1972. At the conclusion of the faceoff, the YA-10 came out on top despite both aircraft exceeding requirement specifications. This was due to:

- Most of the test pilots generally preferred the flying qualities of the YA-10 over the YA-9
- Less roll inertia
- Ease of access to the under-wing hardpoints
- Shorter estimated transition from prototype to production model
- Use of the existing TF-34 engine that had already been in use with the U.S. Navy S-3 Viking
- Better system redundancy / survivability

The YA-10 was announced the winner on January 18, 1973. It is interesting to note that the losing YA-9A bears a striking resemblance to the Russian-developed Su-25 CAS aircraft that has seen service world-wide in large numbers. This is a testament to the excellent design of both contenders.

If you are interested in the Su-25, we suggest flying our simulation of the Su-25T in "Lock On: Platinum", available at your local retailer.

Production

After the pre-production \$159.2 million contract was signed on March 1, 1973, 10 pre-production YA-10s went into construction by Fairchild Republic. In parallel, General Electric was funded to provide slightly modified TF34 engines. The modified engine is hardier and became designated the TF34-GE-100A. While there has been discussion updating the engines of the A-10, the TF-34-100A has proved a reliable and durable engine for the past 40 years.

Responding to a congressional recommendation, the Air Force was asked to evaluate the new YA-10 against the existing A-7D Corsair II. Between April 16 and May 10, 1973, the two aircraft squared off at McConnell AFB by experienced Air Force pilots to evaluate which aircraft was better suited to the initial A-X requirements. At the end of the second evaluation fly-off, the YA-10 was again deemed to be the better aircraft for the mission due to:

- More survivable
- More lethal with the to-be-fitted 30 mm cannon
- Less expensive to operate
- Significantly longer loiter times. Two hours versus only 11 minutes of the A-7D!



Figure 4. A-10A in the earlier camo

The first pre-production YA-10 entered testing in February of 1975 and included several changes from the two prototype aircraft that took part in the fly-off competitions (YA-9 and A-7D). During this time, the number of pre-production aircraft was reduced by four due to budget constraints. These changes included:

- Added leading edge slats for improved airflow to engines at higher angles of attack
- Added trailing edge fairings
- Wingspan slightly increased
- Maximum flap deflection was reduced
- Vertical stabilizers were reshaped
- Aerial refueling receptacle was added to the nose
- Added an integrated boarding ladder
- Gun boresight was reduced 2° for better over-the-nose aiming
- A pylon on the right side of the forward fuselage was added to carry the Pave Penny pod laser spot tracker

The six pre-production aircraft created were each tasked to specific areas of the aircraft flight test program:

- Aircraft No. 1, 73-1664. Performance and handling
- Aircraft No. 2, 73-1665. Weapon certification
- Aircraft No. 3, 73-1666. Sub-systems and weapon delivery
- Aircraft No. 4, 73-1667. Operational test and evaluation
- Aircraft No. 5, 73-1668. Independent Initial Operational and Evaluation (IOT&E) and stores certification
- Aircraft No. 6, 73-1669. Climate test certification

Note: Aircraft No. 6 was lost due to gun gas ingestion that flamed out both engines. This was later rectified in production aircraft.

The first production A-10A flew on October 10, 1975, and along with the next three production aircraft, took part in the flight-testing effort. Due to the reduction in test aircraft from 10 to 6, the first operational A-10A was delivered five months behind schedule to the 355th Tactical Fighter Wing (TFW) in March 1976. By today's standards, not much of a delay! The 355th conducted final operational tests and brought the A-10A to Europe for the first time for air shows and NATO exercises. 355th A-10As went on to put the new aircraft through its paces during Operation Jack Frost arctic exercise, Red Flag, and the Joint Attack Weapon System (JAWS) trials.



Figure 5. A-10A at JAWS Trials

At the delivery of the 100th A-10A, the Pentagon christened the aircraft the Thunderbolt II. However, in the tradition of the F-84 nickname "Groundhog", the F-84F "Superhog" and the F-105 "Ultra-Hog", the A-10A community nicknamed the A-10A the "Warthog" or just "Hog" for short. This nickname tradition coupled with the not-so-graceful lines of the A-10A was quite apt.

In an effort to create a night-attack all-weather version of the A-10, Department of Defense (DoD) and Fairchild Republic converted pre-production aircraft No. 1 to create the YA-10B Night/Adverse Weather (N/AW) prototype. It included a second seat for a weapons system officer responsible for ECM, navigation and target acquisition. The vertical stabilizers were also extended. A Forward Looking Infrared (FLIR) pod was to be mounted on the right side of the fuselage and a ground mapping radar on the left side. In the event the Air Force lost interest, it was also proposed as a combat-trainer for the A-10. The variant was ultimately canceled and the only two-seat A-10 built now sits at Edwards Air Force Base.

In total, 715 A-10s were produced, the last delivered in 1984.



Figure 6. A-10A in Operation Colors

A-10 Evolution

The A-10 has received many upgrades over the years.

Initial aircraft were upgraded with the Heading Attitude Reference Systems (HARS) that provided basic inertial navigation and the Pave Penny laser sensor (marked target seeker) pod that allowed the pilot to detect laser energy for PID (Positive Identification) of an illuminated target. The Pave Penny is a passive seeker and cannot self-designate a target for a Laser Guided Bomb (LGB). Pave Penny control is done through the Target Identification Set, Laser (TISL) panel in the cockpit. Although Pave Penny functions have largely been replaced in modern A-10s by the targeting pod, the system and capability remain.

The first major upgrade to the A-10A fleet was the Low-Altitude Safety and Targeting Enhancement (LASTE). LASTE provided computerized weapon-aiming equipment, a Low Altitude Autopilot (LAAP), and ground-collision avoidance system (GCAS). LASTE updated aircraft evolved over several forms including LASTE v4.0 and LASTE v6.0 with and without embedded GPS INS (EGI) navigation.

The Suite 2 A-10A upgrade standardized the A-10A fleet to full EGI capability, replaced the Control Display Unit (CDU), replaced the defensive countermeasure systems (CMS), and provided the ability to employ the Litening AT targeting pod from either station 3 or 9 (later moved to stations 2 and 10 in Suite 3). Imagery from the targeting pod could be displayed on the Television Monitor (TVM) that could also display Maverick video or as a CDU repeater. Suite 2 also made the Integrated Flight & Fire Control Computer (IFFCC) standard and dramatically improved weapon delivery accuracy.



Figure 7. A-10A Cockpit

The current Suite 3 A-10 has been designated the A-10C. This upgrade started in 2005 and will eventually be standard for the entire A-10 fleet of 356 aircraft. The Precision Engagement (PE) modification is the largest single upgrade effort ever undertaken for A-10. When complete, it will provide true precision engagement (PE) capability by combining multiple upgrade requirements into a one time and money-saving program rather than executing them as standalone projects. This program was accelerated by 9 months as a result of experiences in Operation Iraqi Freedom.

A multi-billion-dollar wing replacement program supplements the technology upgrades including support for IAM-guided weapons (JDAM and WCMD), SA Link, Digital Stores Management System, and an updated, glass cockpit. Overall, an April 2/07 GAO report places the potential total cost of upgrades, refurbishment, and service life extension plans for the A/OA-10 force at up to \$4.4 billion.



Figure 8. A-10C Cockpit

The Air Force Material Command's Ogden Air Logistics Center at Hill AFB, Utah completed work on its 100th A-10 precision engagement upgrade in January 2008. The A-10C upgrades are to be completed in 2011. The A-10 is scheduled to stay in service with the USAF until 2028 and will continue to evolve with new upgrades.

A-10 Missions

In the 30+ years of operational service, the A-10 mission has continued to evolve to meet ever-changing mission requirement and battlefield complexities. Meeting the initial A-X requirements, the A-10 was initially focused on Close Air Support (CAS) of friendly troops in contact with Warsaw Pact forces in the event of the Cold War going hot. However, with actual A-10 combat operations in the Persian Gulf, the Balkans, and Afghanistan, the initial low-altitude CAS mission changed dramatically.

Given the much greater air defense threat at low-altitude compared to medium altitude, A-10 operations generally moved to medium altitude (12,000 to 20,000 ft) to minimize the threat from Anti-Aircraft Artillery (AAA) and Man Portable Surface to Air Missiles (MANPAD). This was made possible due either to a lack of credible medium to high altitude air defense threats and/or sufficient friendly support assets to neutralize the threat. As such, most of the A-10s combat use has been above 12,000 ft with excursions to lower altitude to employ weapons (strafing and CCIP rocket/bomb delivery). Today's A-10C in particular use a combination of the Litening AT targeting pod with precision-guided bombs and missiles to attack from medium altitudes and stand-off ranges to avoid low-altitude threats.

Working from these altitudes in such a manner, the A-10C has four general types of missions it can conduct:

Close Air Support (CAS)

As the initial mission of the A-10, this is what it was designed to do... provide direct support to friendly ground forces in contact with the enemy. Although this was originally envisioned as NATO forces holding off a Warsaw Pact advance, today CAS is a common mission for A-10C crews supporting allied forces in Iraq and Afghanistan. Often A-10C crews will be tasked to eliminate hostile forces within "danger close" range of friendly units. The updates to the A-10C of the better integrated targeting pod and the SA Link system provide an improved level of coordination and weapon employment accuracy to avoid tragic blue-on-blue, friendly fire incidents.

Paramount of effective CAS support is the Joint Terminal Attack Controller (JTAC) on the ground with friendly troops. It is the JTAC's mission to coordinate with the A-10C pilot to effectively and accurately deliver weapons exactly on the directed target to best support the friendly ground forces in contact with the enemy. With the integration of the datalink, a JTAC can now send digital tasking onto the moving map display and a text message. However, this does not preclude the traditional verbal directions over a radio to talk the pilot's eyes onto the intended target.

Battlefield Air Interdiction (BAI)

The goal of BAI is to use airpower to attack enemy forces behind the front line that are not in contact with friendly forces. This can include rear echelon reinforcements, artillery/rocket system, logistics, and lines of communication. Depending on how far the target is behind the front line, there are generally two levels of BAI: Deep Interdiction against targets far behind the front line that generally consisted of logistical, command and control, line of communication, and Petroleum, Oil, Lubricants (POL) targets; and Battlefield Interdiction targets second-echelon forces behind the front line that are currently not in contact with friendly ground forces.

For many years the A-10 was relegated to Battlefield Interdiction while other aircraft such as the F-15E, F-16, F-117, and F-111 took the Deep Interdiction missions. However, this has gradually changed and now BAI mission assignments are based on weather, target type, expected threats, and terrain. As such, more and more A-10s are assigned both types of BAI missions.

Because targets are well behind the front line, contact with a JTAC is rare except when tasked by a Special Forces team behind enemy lines.

For combat operations like Desert Storm and Allied Force, this was the most common type of mission. In ODS, A-10 crews were often assigned "Kill Boxes" to hunt for and destroy enemy units. In OAF, there was a similar target area assignment, but also target handoff from an Airborne Forward Air Controller (AFAC).

Airborne Forward Air Controller (AFAC)

Much like a JTAC tasks a CAS-assigned aircraft to a specific target, the AFAC performs the same role but from the cockpit of an aircraft. Unlike a JTAC that is most often assigning CAS strikes, the AFAC often performs the dual function of assigning both CAS and BAI attacks. Clear examples of this can be seen in the AFAC role the A-10 often played in coordinating BAI strikes in the Balkans, whereas the A-10 AFAC role in Iraq and Afghanistan was often tasking CAS strikes supporting friendly troops in contact.

When an A-10 is performing the AFAC role, it is termed an OA-10. There is no real difference between an A-10 and an OA-10 other than the mission and the OA-10 will generally have an AFAC payload consisting of Willy Pete marker rockets and several weapons. An A-10 that is dual tasked for CAS/BAI and AFAC is sometimes referred to as an A/OA-10 or a "Killer Scout".

With the addition of the Litening AT targeting pod, the A-10 is a much more capable AFAC that can operate day or night. Previously, nighttime AFAC could be problematic and relied solely on the use of night vision goggles (NVG). For daytime AFAC, the older OA-10 models had to use binoculars.

Along with the targeting pod, the SA Link allows the OA-10 to digitally transmit target locations to other aircraft on the network as well as sending clarifying text messages. Of course, the verbal “talk on” is also available over the radio.

Combat Search and Rescue (CSAR)

When an airman goes down behind enemy lines, an A-10 flight is a crucial part of the package that will go in to retrieve him or her. In the CSAR role, the A-10 will often be the on-site coordinating party responsible for the extraction operation. Additionally, the A-10 will have responsibility for attacking enemy forces threatening the rescue helicopters and enemy ground forces closing in on the position of the downed pilot.

During operations of Serbia and Kosovo, both CSAR operations were run from the cockpit of an A-10.

Operational Use

The first operational unit to receive the A-10 was the 355th Tactical Training Wing, based at Davis-Monthan Air Force Base in Arizona in March of 1976. The first unit to achieve full combat-readiness was the 354th Tactical Fighter Wing at Myrtle Beach AFB, South Carolina in 1978. Deployments of A-10s followed at bases both at home and abroad. A-10s are deployed with active duty, Reserve, and Air National Guard (ANG) squadrons. Current operators of the A-10 as of mid-2009 include:



Figure 9. 25th Fighter Squadron 'Assam Draggins', 51st Fighter Wing (PACAF), Osan AB, Republic of Korea, Tailcode OS



Figure 10. 47th Fighter Squadron (Training), 917th Wing (ACC), Barksdale AFB, Louisiana, Tailcode BD



Figure 11. 74th Fighter Squadron 'Flying Tigers', 23rd Fighter Group, 23rd Wing (ACC), Moody AFB, Georgia, Tailcode FT



Figure 12. 75th Fighter Squadron 'Tiger Sharks', 23rd Fighter Group, 23rd Wing (ACC), Moody AFB, Georgia, Tailcode FT



Figure 13. 81st Fighter Squadron 'Panthers', 52nd Fighter Wing (USAFE), Spangdahlem AB, Germany, Tailcode SP



Figure 14. 103rd Fighter Squadron, 111th Fighter Wing (Pennsylvania ANG), Willow Grove ARS, Pennsylvania, Tailcode PA



Figure 15. 104th Fighter Squadron, 175th Wing (Maryland ANG), Martin State AP Air Guard Station, Baltimore, Maryland, Tailcode MD



Figure 16. 107th Fighter Squadron, 127th Wing (Michigan ANG), Selfridge ANGB, Michigan, Tailcode MI



Figure 17. 172nd Fighter Squadron, 110th Fighter Wing (Michigan ANG) Battle Creek ANGB, Michigan, Tailcode BC. Note that in 2008 these aircraft were moved to Selfridge ANGB, Mt. Clemens, Michigan as part of the 127th Wing to replace the F-16's that were previously stationed there.



Figure 18. 184th Fighter Squadron, 188th Fighter Wing Flying Razorbacks (Arkansas ANG), Fort Smith Regional Airport, Fort Smith, Arkansas, Tailcode FS



Figure 19. 190th Fighter Squadron, 124th Wing (Idaho ANG), Boise ANGB, Idaho, Tailcode ID



Figure 20. 303rd Fighter Squadron, 442nd Fighter Wing (AFRC), Whiteman AFB, Missouri, Tailcode KC



Figure 21. 354th Fighter Squadron 'Bulldogs', 355th Fighter Wing (ACC), Davis Monthan AFB, Arizona, Tailcode DM



Figure 22. 357th Fighter Squadron 'Dragons' (Training), 355th Fighter Wing (ACC), Davis Monthan AFB, Arizona, Tailcode DM



Figure 23. 358th Fighter Squadron 'Lobos' (Training), 355th Fighter Wing (ACC), Davis Monthan AFB, Arizona, Tailcode DM



Figure 24. 66th Weapons Squadron, Nellis AFB, Nevada, Tailcode WA



Figure 25. 422nd Test & Evaluation Squadron, Nellis AFB, Nevada, Tailcode OT

Operation Desert Storm

In 1991 the 23rd, 354th and 917th Tactical Fighter Wings (TFW) deployed to King Fahd International Airport and Al Jufair airfields in Saudi Arabia to support Operation Desert Storm (ODS). Consisting of 144 A-10s, the A-10 deployment contributed 16.5% of total coalition sorties during ODS.

The primary focus of A-10 operations was the seven Iraqi Republican Guard divisions along the Iraq-Kuwait border. The goal of this effort was to dramatically reduce the combat effectiveness of these divisions before the coalition ground assault.



Figure 26. A-10A in Operation Desert Storm

Some of the more remarkable statistics the A-10 achieved are:

- 987 Iraqi tanks destroyed
- 501 armored personnel carriers destroyed
- 249 command and control vehicles destroyed
- 1,106 trucks destroyed
- 926 artillery pieces destroyed
- 96 radars destroyed
- 72 bunkers destroyed
- 50 AAA sites destroyed
- 28 command posts destroyed
- 11 MRL destroyed
- 10 parked aircraft destroyed
- 9 SAM sites destroyed
- 2 helicopters destroyed with the GAU-8/A gun
- 19,545.6 hours / 8,755 sorties

- 7,445 weapons delivered
- 98.87% mission reliability rate

Most mission days consisted of three missions over an 8-hour period. However, mission days were expanded to a 10-hour flying day when A-10s were tasked for "Scud Hunting" duties in the western desert.



Figure 27. A-10's kills

In addition to BAI and "Killer Scout" missions, A-10s also maintained CSAR strip alert.

Both wings had one squadron assigned to night sorties and this often comprised the use of night vision goggles and using the seeker from an Infrared Imaging (IIR) AGM-65D Maverick to hunt for targets at night.

The strong contribution of the A-10 in ODS contributed in a large way to the Air Force reversing its decision to phase out the A-10 and replace them with a CAS version of the short-legged, "drop-two-bombs, and run" F-16.

Operation Allied Force

The A-10 saw its next combat in 1999 when the 81st FS deployed to Aviano AB in Italy in support of Operation Joint Forge. With a deployment of 15 aircraft by 23 March, combat operation over Kosovo commenced with the goal of removing all Serbian forces from Kosovo. This marked the start of Operation Allied Force.



Figure 28. A-10 Thunderbolt II at Gioia del Colle, Italy, for a NATO Operation Allied Force mission on April 12, 1999

On March 27, A-10s from the 81st FS led the CSAR effort to retrieve a downed F-117 pilot.

In early April of 1999, A-10s conduct their first successful attacks. A-10s were tasked with a combination of both CAS and AFAC duties. Whereas F-16 units provided nighttime AFAC, A-10 units provided daytime AFAC support to coalition aircraft operating over Kosovo. Also in April, the 81st FS did a remarkable and rapid re-deployment from Aviano AB to Gioia del Colle AB in southern Italy and elements of the 74th FS from Pope AFB were co-deployed with the 81st FS. This relocation placed A-10 units much nearer to Kosovo and increased their mission effectiveness.

Near the end of the operation, the 103rd, 172nd, and 190th FS deployed to the region.

During the operation, A-10 units accounted for the destruction of more Serbian deployed weapons than any other aircraft. Additionally, the A-10 in its CSAR role was a large part of why no downed allied pilot was ever captured. Although two A-10s received battle damage, not even one was lost to enemy fire.

As with ODS, OAF showed that the A-10 could be an effective platform in today's battlefield.

Current Operations in Iraq and Afghanistan

Following the events of 9/11, US forces conducted combat operation in Iraq (Operation Iraqi Freedom) and in Afghanistan (Operation Anaconda).

In support of Operation Iraqi Freedom, 60 National Guard and Reserve A-10s from various squadrons were deployed to the region in support of the initial ground offensive. Despite losing one aircraft to hostile fire late in the operation, A-10s provided valuable CAS to rapidly advancing forces and contributed to the rate of advance. In addition to traditional CAS operations, A-10 units also conducted BAI along the line of advance. A-10 units concluded the operation with a 85% mission capable rate and fired 311,597 rounds of 30 mm gun ammunition. In late 2007, the Maryland ANG 104th FS took the A-10C into combat for the first time.



Figure 29. A-10 Thunderbolt II maintenance members inspect aircraft after it was hit by an Iraqi missile

A-10 operations in Afghanistan first began from Bagram airfield. They then later moved operations to Kandahar airfield. More so than ODS and OAF, A-10 operations in Afghanistan have focused heavily on CAS and AFAC missions.

GENERAL DESIGN



GENERAL DESIGN

The A-10A/C is a fixed-wing, single-pilot aircraft with two high bypass turbofan engines that is optimized for the Close Air Support (CAS) combat mission. Originally designed to counter a mass-Soviet armor thrust across Europe, the A-10 was designed from the ground up to be the most survivable and potent CAS aircraft over a very deadly battlefield.

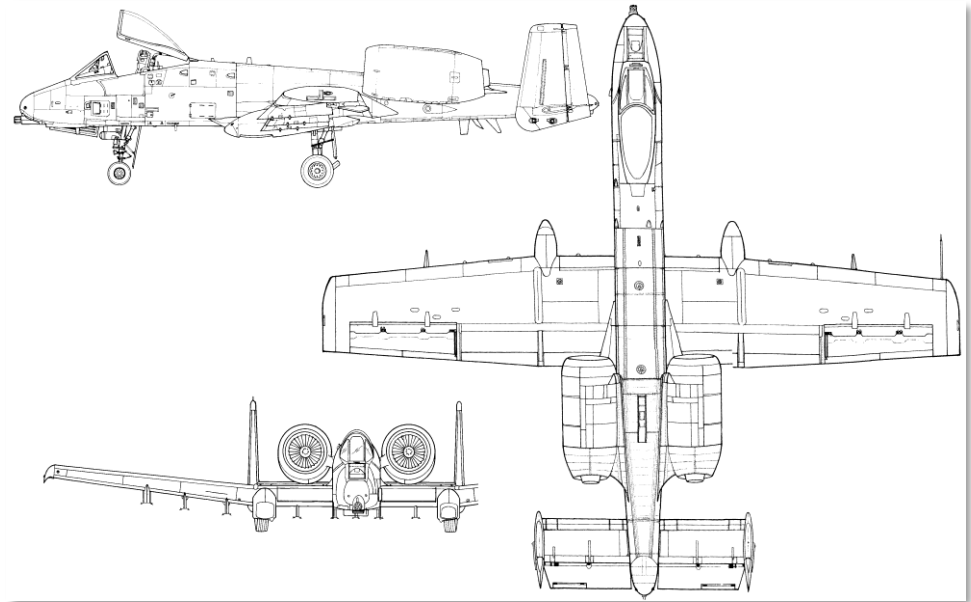

Figure 30. A-10A

In this chapter, we will discuss the various design components of the A-10 and how they contribute to its combat mission.

Fuselage and Wings

The A-10 uses stressed, machined skin panels to cover the fuselage and wings. A system of ribs, spars and bulk heads in turn strengthen the internal assembly to provide a rigid and robust structure.

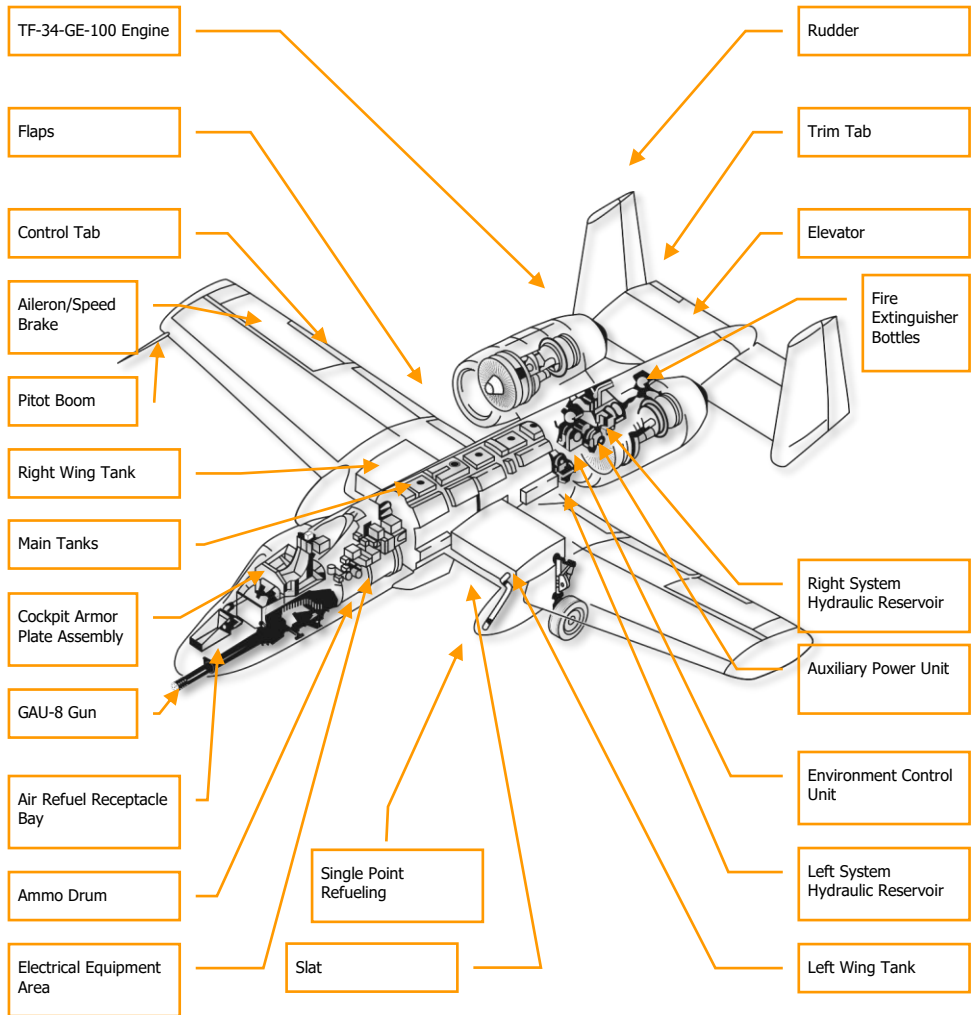

Figure 31. General A-10 Design Features

Fuselage

The most forward section of the fuselage houses the GAU-8/A 30 mm gun barrels and firing mechanism that extend back behind the cockpit. Alongside of the gun barrels is the nose gear that is installed right of centerline. This allows the gun to be mounted centrally along the fuselage for increased accuracy. The nose gear retracts fully into the fuselage. The cockpit sits high over the gun and nose gear bay and consists of a retractable Plexiglas canopy, a zero-zero ejection seat, and the various cockpit controls and instrumentation. The high, forward position of the cockpit provides excellent visibility over the nose. Additionally, the forward fuselage houses multiple avionics bays, the aerial fueling receptacle, and other equipment.

The center section of the fuselage contains the forward and aft fuselage fuel tanks. Along the lower surface of the center fuselage are the hard points for store stations 5, 6 and 7. Loading on stations 5 and 7 is exclusive to loading on station 6. Generally, station 6 is only loaded with the TK600 external fuel tank.

The aft portion of the fuselage has the two primary functions of mounting the two engine nacelles and the attachment point to the elevator and rudder control surface assemblies. Mounted on either side of the aft fuselage spine are the two nacelles for the TF-34-GE-100 engines. Between the nacelles and inside the fuselage are Auxiliary Power Unit (APU), the left and right hydraulic system reservoirs, and the Environmental Control Unit (ECU).

Wings

The wings of the A-10 are of the low-mounted straight design and provide low wing loading. This provides excellent maneuverability and a low stall speed. However, it does limit the A-10 to pedestrian speeds compared to other fighter aircraft. This does provide the A-10 the ability to better loiter over the battlefield in both regards to endurance and more easily stay over a CAS assigned target area. The wings have Hoerner wingtips that reduce induced drag and wingtip vortices. They also improve aileron effectiveness at low speeds.



Figure 32. A-10 maintenance

At the base of the left and right wing are the left- and right-wing fuel tanks. Additionally, TK600 fuel tanks can also be mounted on wing stations 4 and 8. Fuel is first depleted from any external tanks and then the wing tanks. As with the fuselage tanks, the tanks are self-sealing and filled with a flexible foam to prevent a fuel tank explosion. Note that the external tanks do not have such precautions and are never flown with in combat.

On the inside leading edge of the wings are the slats that automatically deploy according to Angle of Attack (AoA). They only have two positions and are deployed down to improve air flow to the engines at high AoA. This is governed by the Emergency Stall Prevention System (ESPS).

On the side trailing edge of the wings are the flaps. The flaps are generally manually controlled from the flap lever on the throttle quadrant and can be set to UP (0°), MVR (7°), and DN (20°). Flaps will not extend, but will auto-retract, if the airspeed exceeds 185 to 219 KIAS depending on altitude. Flap position is indicated in the cockpit on the flap position indicator. The flaps themselves are divided into two outer and inner "wings". They all raise and lower simultaneously. Flaps are set to MVR for takeoff.

Underneath each wing and extending forward left and right of the slats are the wheel wells. The two main gears are partially covered by the wells and the gear retract forward into them. The forward end of the left wheel well housing contains the single point refueling receptacle. The corresponding right wheel well end is colored black and houses the IFF receiver.

On the outer left and right trailing edges are the ailerons that can also split to act as speed brakes.

Beneath the wing are the remaining eight hard points that a wide variety of stores can be mounted on. These include single pylons, Triple Ejector Racks (TER), Maverick and AIM-9 launchers, etc. Stations 3, 4, 5, 7, 8 and 9 are 1760 smart stations and allow the A-10C to talk to stores such as IAMS, targeting pods, and Maverick.

Control Surfaces

The three controlling forces on the aircraft are pitch, roll and yaw, and these in turn are provided by the elevator, aileron and rudder control surfaces on the aircraft. These control surfaces have the following functionality and characteristics that are often unique to the A-10.



Figure 33. Control Surfaces

Elevators

Pitch control is provided by two elevators attached to the trailing end of the horizontal stabilizer. The two elevators are attached using a shearable crossover shaft that can be sheared if one of the elevators becomes jammed. This will allow the other to still operate but with less pitch authority.



Figure 34. Elevator

Each elevator is in turn powered by a separate hydraulic actuator. Inputs to the actuators are made via independent cable paths that connect directly to the disconnect units. A series of push rods then provide input from the control stick to the disconnect unit. If the elevators are still connected with the shearable crossover shaft, a single elevator actuator / control path can power both elevators if one of the actuators or control paths fail.

Elevator trim is provided by trim tabs on the outboard trailing edge of the elevators and can be set both from the control stick and from the Emergency Flight Control System panel using independent electrical circuits. These circuits lead to a trim motor that sets the trim tabs and provides artificial feel.

Pitch Stability Augmentation System (SAS) satisfies IFFCC pitch commands during PAC operation and provides pitch rate damping, pitch trim compensation during speedbrake deployment, and normal pitch trim. If an elevator jams in place, the Elevator Emergency Disconnect switch can be used to free it.

Ailerons

Roll control is provided by the two ailerons at the trailing outside end of each wing. Each aileron is powered by either hydraulic system. Roll inputs from the control stick are sent to a disconnect unit through push rods. From the disconnect units, inputs are sent to the hydraulic aileron actuators using cables and linkage paths.

Because of the tandem hydraulic control mechanism, the loss of one system will not impact aileron control.

If however the linkage is lost to one of the actuators, roll control will only be supplied by the operating aileron. As such, roll control authority will be reduced by half and greater stick forces will be required.



Figure 35. Wing Tip and Aileron

If an aileron jams in place, the Aileron Emergency Disconnect switch can be used to free it.

Aileron trim is provided by trim tabs on each aileron trailing edge that are powered by trim motors. In addition to manual roll trimming of the aircraft, the aileron trim tabs also provide artificial stick feel. Even if the aileron of the trim tab is disengaged, the trim will still function.

Note that roll trim is not available when in Manual Reversion Flight Control System (MRFC) mode. Instead, stick movements drive the roll trim tabs.

In addition to the primary function of imparting roll control to the aircraft, each aileron can also split vertically to form a speed brake.

Rudders

Yaw control is provided by the two rudders running vertically down the trailing edge of the vertical stabilizers. Each rudder is powered by separate hydraulic actuators that are in turn connected to the rudder pedals via a cable and linkage path. Unlike the elevators and ailerons, there is no disconnect option.

If hydraulic power is lost to a rudder, control of both rudders is still possible, but an increase in pedal input will be required. If, however, power is lost to both, direct control using the cables is automatically provided.

Flight Control Systems (FCS)

The primary elements of the A-10C Flight Control Systems (FCS) of the A-10 include the Stability Augmentation System (SAS), the Manual Reversion Flight Control System (MRFC), and the Enhanced Attitude Control System (EAC). In combination and according to the situation, the FCS determines how the pilot's control inputs are transferred to the aircraft.

Stability Augmentation System (SAS)

The SAS improves the handling qualities of the A-10 and allows better and finer control. This results in better target tracking and reduces the amount of trimming needed.

SAS consists of control inputs in two channels: the pitch axis and the yaw axis. Note that SAS does not affect roll. As you might imagine, the pitch channel acts on elevator control input and the yaw channel acts on rudder input.

Pitch SAS

The SAS pitch channels allows the Integrated Flight and Fire Control Computer (IFFCC) to provide pitch control functions up to +5/-2 elevator trailing edge. The most noticeable effect of this is pipper tracking on a target through the HUD in the pitch axis.

Yaw SAS

The SAS yaw channels have three main functions:

- $\pm 7^\circ$ of yaw rate dampening
- $\pm 7^\circ$ of rudder authority for turn coordination
- $\pm 10^\circ$ of rudder authority for yaw trim

The SAS continuously compares the output of the two channels, and if there is an excessive difference, the system will automatically deactivate both channels of the axis.

SAS can also be disconnected with the SAS disconnect button.

For SAS operation, hydraulic power must be provided.

Manual Reversion Flight Control System (MRFCS)

The MRFCS is used for emergency situations when both hydraulics systems have failed or a complete failure is impending. Flight control is radically reduced and primarily relies on use of trim tabs to fly the aircraft. While sufficient for light maneuvering, it is not feasible to land with.

MRFCS Pitch

Control is shifted from hydraulic to mechanical (push rods and cables). Trim is still provided in pitch.

MRFCS Roll

Control is shifted from hydraulic to stick control moving aileron trim tabs.

MRFCS Yaw

Control is shifted from hydraulic to mechanical (push rods and cables)

Enhanced Attitude Control System (EAC)

The EAC system was one part of the LASTE update to the A-10A that provides an autopilot capability. EAC uses sensor data from the Embedded GPS INS (EGI) navigation system, the Central Air Data Computer (CADC) and the SAS, and then provides input into elevator and yaw as part of the SAS.

The EAC system provides two major FCS functions:

- **Precision Attitude Control (PAC)**. In PAC 1, pressing the trigger in Gun master mode will trim the aircraft through SAS to keep the gun piper on the target point.
- **Low Altitude Autopilot (LAAP)**. This includes the autopilot modes of Altitude/Bank Hold, Altitude/Heading Hold, and Path Hold modes.

Combined, the FCS of the A-10C provides a good, stable weapons platform to accurately employ weapons from. However, unlike an F-16 for example, its FCS is not a fly-by-wire system and the pilot is much more in charge of what the aircraft is doing rather than being a voting member. As such, the A-10 is very much a seat-of-your-pants aircraft to fly and can be extremely responsive in the right hands.

Engines and APU

Engines

All versions of the A-10 have been powered by twin TF-34-GE-100A engines that are mounted high on the rear fuselage between the wings and the rear stabilizers. The unusual placement of the engines provides several distinct advantages:

- The high mounting reduces the likelihood of the engines ingesting Foreign Object Debris (FOD) when operating from rough, forward bases in war-time.
- Engines can remain running when aircraft is being rearmed and refueled. This leads to faster mission turn-around.
- Ease of servicing the engines.
- Reduced IR signature from below due to the shielding of the horizontal stabilizer.

Each engine is housed in a nacelle with maintenance doors that provide easy access. At maximum thrust, each engine produces 8,900 pounds of standard thrust at sea level on a standard day. Although there has long been talk about upgrading the A-10 engines, this has yet to happen. As such, the A-10 is not a speed demon, but it does have reliable, fuel economic and durable engines in its current form.

From engine IDLE to MAX takes approximately 10 seconds at sea level. Thrust (amount of fuel supplied to the engines) is governed by the two throttle levers in the cockpit.

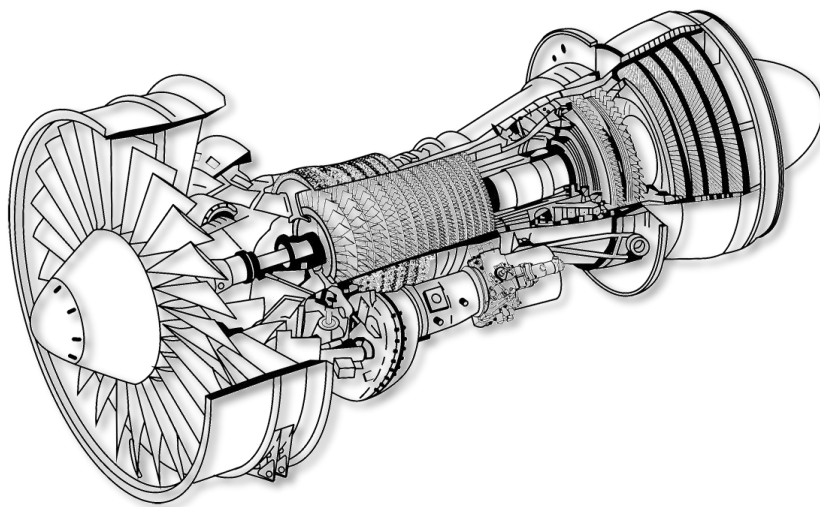

Figure 36. TF-34-GE-100A

The TF-34 is a high-bypass turbo fan that generates 85% of its thrust with bypass air. To do so, it uses a single-stage bypass fan and a 14-stage axial flow compressor. Because most of the thrust is generated by the bypass fan, the best indication of thrust in the cockpit is from the fan speed indicators. Bleed air can be siphoned from the fan to power additional systems.

Within the fan section are the inlet guide vanes that automatically adjust themselves to maximize thrust through the entire engine operating range.

Behind the fan section and below the compressor is the accessory gearbox that provides power to a hydraulic pump, fuel pump, oil pump, and electrical generator. Each engine has its own accessory gearbox and own set of associated pumps and generators. This provides redundancy.

Above the accessory gear box are the first stage compressor stages that flow and compress air into the combustion stage behind it. In the combustion stage, the high-pressure air and fuel (according to throttle settings) are mixed and ignited. This ignited fuel mixture is then expelled through the high-pressure turbine stage. From the high-pressure turbine stage, the thrust is exhausted out through the back-end low pressure turbine and then out the back of the engine.

Auxiliary Power Unit (APU)

Located in the rear fuselage between the engine mounts is the APU. The APU is a small engine itself and draws fuel to run. When running, the APU supplies compressed air to turn the compressor fans to start the engines. The APU also drives an electrical generator and a hydraulic pump. Once both engines are started and their generators enabled, the APU and APU generator can be shut down. You would only need to use the APU again in case of an engine re-start.

Avionics Systems

Over the last 30 years, the A-10 has seen numerous improvements and most of these have had to do with the avionics systems. Although the A-10 avionics systems began rather simple, they have evolved over the years with some of the more notable changes:

- Multiple LASTE versions
- Addition of GPS navigation and integration with INS (EGI)
- Suite 2 A-10A
- Suite 3 A-10C (subject of this simulation)



Figure 37. A-10C Cockpit

Regarding the A-10C, the avionics are a combination of old and new. Most of the engine, fuel, hydraulics, electrical, flight control, emergency and lighting systems have remained the same since the first A-10A went operational. However, the current A-10C has a great many differences in regard to the integrated weapon and navigation system, sensor usage (targeting pod), communications, datalink, and systems monitoring.

The most visibly obvious result of the upgrades has been to the cockpit of the A-10C. The Precision Engagement (PE) Modification Program made several important changes to the cockpit to support the avionics upgrades:

- New control stick based on the F-16 stick. Although it is a full-deflection stick (unlike the F-16), it has a much greater level of functionality compared to the older stick based on the F-4 "Phantom" stick.

- The right throttle of the throttle quadrant has been removed and replaced by the same right throttle used in the F-15E. As with the new control stick, the new right throttle provides an additional level of control and functionality.
- Below the HUD is the new Up Front Control Panel (UFC) and this is a combination of buttons and rocker switches that allow the pilot to more easily input data and control sub-systems at eye-level.
- Dominating the new front dash of the A-10C are two 5x5 inch Multi-Function Color Displays (MFCDD). Both MFCDD can display a wide variety of data including the Tactical Awareness Display (TAD) with moving map, Targeting Pod (TGP) video, Maverick (MAV) seeker video, Digital Stores Management System (DSMS), Aircraft Status (STAT), and repeat data from the EGI navigation system. This essentially added a "glass cockpit" to the A-10 and brought it into the 21st century.
- A new Armament HUD Control Panel (AHCP), replacing the old Armament Control Panel (ACP) of the A-10A. Most of the functions of the ACP have been moved to the DSMS page on an MFCDD and the AHCP now controls basic power and operating mode of the major aircraft weapon, sensor, and navigation systems.

Pilot Survival and System Redundancy

The A-10 is an exceptionally survivable aircraft with excellent pilot protection. Its strong airframe can survive direct hits from armor-piercing and high-explosive projectiles up to 23 mm. The aircraft has triple redundancy in its flight systems, with mechanical systems to back up double-redundant hydraulic systems. This permits pilots to still fly when hydraulic power or part of a wing is lost using the Manual Reversion Flight Control System (MRFCSS). In manual reversion mode, the A-10 is sufficiently controllable under favorable conditions to return to friendly airspace.

The aircraft is designed to fly with one engine, one tail, one elevator and half a wing torn off. The self-sealing fuel tanks are protected by fire-retardant foam. Additionally, the main landing gear is designed so that the wheels are retracted to make gear-up landings easier to control and less damaging to the aircraft's underside. They also are all hinged toward the rear of the aircraft, so if landing gear hydraulic power is lost, the pilot can simply drop the gear and a combination of gravity and wind resistance will open and lock the gear in place.

The cockpit and parts of the flight-control system are protected by 900 pounds (408 kg) of titanium armor, referred to as a titanium "bathtub". The tub has been tested to withstand strikes from 23 mm cannon fire and some strikes from 57 mm rounds. It is made up of titanium plates with thicknesses

from ½ inch to 1½ inches determined by a study of likely trajectories and deflection angles. This protection comes at a cost, though; the armor itself weighs almost 6% of the entire aircraft's empty weight. To protect the pilot from the fragmentation likely to be created from impact of a shell, any interior surface of the tub that is directly exposed to the pilot is covered by a multi-layer Kevlar spall shield. The canopy consists of a bullet-proof diffusion-bonded stretched-acrylic to withstand small arms fire and is resistant to spalling. The front windscreen offers shielding resistant to 20 mm cannon fire.

Radio Equipment

The A-10C radio communications suite includes two AN/ARC-186(V) VHF radios and one AN/ARC-164 UHF radio. These radios can be used for both open and secure voice, data and ADF communications. Additionally, the back left console houses the intercom control head that allows the pilot to adjust radio and other audio device volumes.



Figure 38. Left Console Showing VHF and UHF Radios

For secure communications, the A-10 includes the KY-58 Secure Voice Control Panel and allows the pilot to set multiple encryption code presets to either VHF or UHF communications.

The IFF/SIF panel allows the pilot to set Mode 1, Mode 2, Mode 3/A, Mode C, and Mode 4 IFF response. Note the A-10 does not have the ability to interrogate other aircraft using IFF.

Countermeasures Systems

When the A-10A Suite 2 was introduced, it included an updated Countermeasure System. This system consists of the Countermeasure Signal Processor (CMSP) on the right console and the Countermeasures Set Control (CMSC) below the HUD. Combined, these two panels allow the pilot to

select and program chaff and flare release programs and set how electronic countermeasures should be used (manual to fully automatic).



Figure 39. Countermeasure Signal Processor (CMSP) Panel

On the left front dash is the ALR-69 Radar Warning Receiver (RWR) and this display alerts the pilot of detected radar signals and the detection of launched missiles via the Missile Warning System (MWS).

The A-10 has four sets of chaff and flare dispensers. Two sets are on the wingtips and these are generally loaded with chaff cartridges. The other two sets are housed in the rear of the main landing gear wheel bays, and these are generally loaded with flares.

A-10C STORES



A-10C STORES

A/A 49E / GAU-8/A

In 1974, YA-10 prototype aircraft No. 1 was retrofitted with the production model GAU-8/A seven-barreled "Avenger" 30 mm cannon and initial tests were performed against an array of M48 and T-62 tanks. These tests proved highly successful. The decision to make the 30 mm GAU-8/A cannon the main anti-tank weapon of the A-10A was influenced by Vietnam-era A-1 pilots and by Hans-Ulrich Rudel and his book, "Stuka Pilot". In World War II, Rudel flew the Ju 87G Stuka for the Luftwaffe and destroyed many Soviet tanks using its two underwing Bordkanone BK 3.7 37 mm caliber anti-tank auto cannon. His book was required reading for members on the A-X project team. The Ju 87G was an outmoded airframe with improvised anti-tank weapons attached, yet still inflicted significant casualties on Soviet tank forces. Particularly for the possible battleground of Western Europe being invaded by hordes of Warsaw Pact tanks, the GAU-8/A was an ideal and necessary choice.

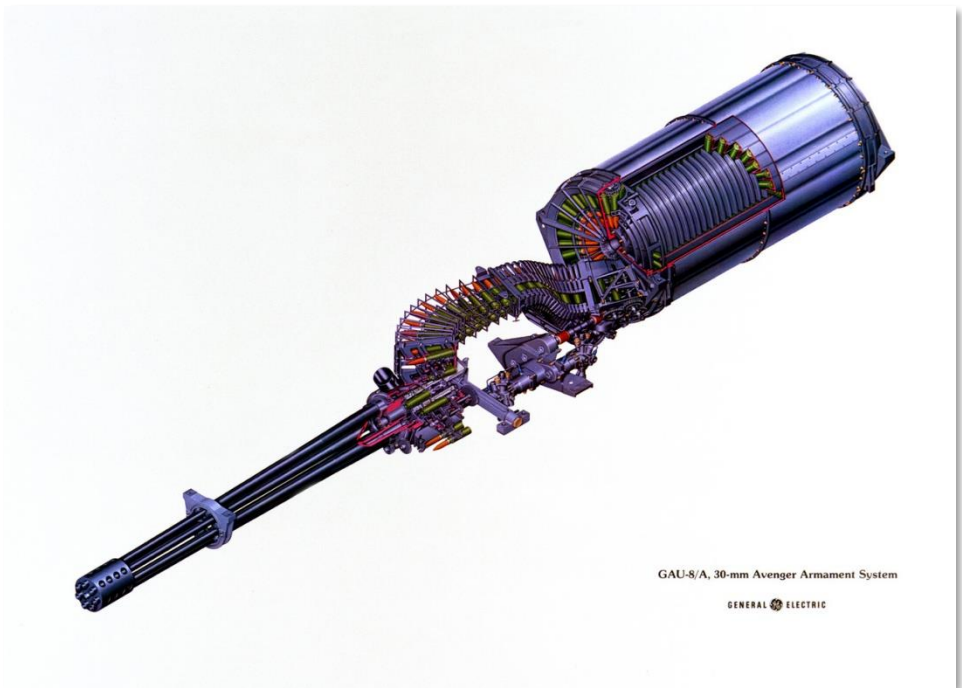

Figure 40. GAU-8/A

Using seven barrels in a rotating Gatling-type system, a very high rate of fire can be achieved without excessive barrel heating. This is because as one barrel fires the other six are briefly cooling down. Each of the seven barrels acts as an individual 30 mm cannon with its own breech and bolt, these are all joined around a single rotor along a common axis using a hydraulic motor.

Test results showed that the 10,000 lb. recoil was sufficient to move the nose of the aircraft. To remedy this, the nose gear was moved to the right and the cannon placed along the center line of the aircraft.

In earlier models of the A-10A, the gun could be fired in either low or high rate of fire. The current version of the A-10C only has a single, high setting.

The GAU-8/A is actually part of the larger A/A 49E-6 gun system that also includes the ammunition drum. The system weighs 4,200 lbs. and weighs as much as a car.



Figure 41. GAU-8/A 30 mm Round

The cannon has three possible ammunition loads and can be configured from the IFFCC Test Menu:

- **Combat Mix (CM).** One PGU-13 High Explosive Incendiary (HEI) for every five rounds of PGU-14 Armor Piercing Incendiary (API) rounds. The API round uses Depleted Uranium (DU) and has a muzzle velocity of 3,240 ft/sec. This is the ammunition of choice for armored vehicles and can destroy a tank out to 21,600 ft. During Operation Desert Storm, 940,254 rounds of CM were fired.
- **High Explosive Incendiary (HEI).** This load exclusively uses the PGU-13 (HEI) round.
- **Target Practice (TP).** Inert warhead round version used for training.

A-10C Station Racks

On each of the 11 weapon stations, one of two types of bomb racks can be mounted and will in some cases depend on the station:

Single Ejector Rack (SER)

This rack mounts a single weapon and is the only rack type or launcher that can be loaded with particularly heavy bombs like the Mk-84 (GBU-31 / GBU-10). The Single Ejector Bomb Rack can be mounted on any of the 11 stations and any of the unguided bombs can be loaded on it depending on the station. For example: Only light bombs can be mounted on far-outboard SERs.



Figure 42. Weapon Station with Single Ejector Rack

Triple Ejector Rack (TER)

The TER allows you to mount three weapons of a single type on a weapon station. The release sequence for weapons on a TER, when facing the TER, is middle→right→left. A TER can only be mounted on stations 3, 4, 5, 7, 8, and 9. Note that BDU-33 can only be mounted on a TER mounted on stations 5 and 7.



Figure 43. Triple Ejector Rack BRU-42

2.75-inch Hydra 70 Unguided Folding Fin Aerial Rockets

The A-10C can employ a wide variety of 2.75-inch Hydra 70 rockets using either the LAU-68/A or LAU-131 seven-tube launchers. Other than a minor weight difference, there is no significant difference between these two launchers. Although initially designed as an air-to-air weapon, the Hydra 70 has evolved into wide array of air-to-surface aerial rockets. All the 2.75-inch Folding Fin Aerial Rockets (FFAR) in this simulation use the MK66 rocket motor. FFAR rockets are an area effect weapon and are certainly not a precision attack weapon. Common targets for most of the rocket warheads include un-armored or lightly armored targets and they can be useful as a suppression weapon.



Figure 44. FFAR



Figure 45. 2.75-inch FFAR Warhead Types

2.75-inch rockets that the A-10C can use include the following warheads:

- **MK1.** Inert warhead practice rocket.
- **MK5.** High explosive anti-tank warhead.
- **MK61.** Inert warhead practice rocket.
- **M151.** Anti-personnel fragmentation warhead.
- **M156.** White phosphorus smoke warhead.
- **WTU1B.** Inert warhead practice rocket.
- **M274.** Training smoke marker.
- **M257.** Parachute-retarded illumination flare.

When a rocket type is selected from the Digital Stores Management System (DSMS) it will be listed by its warhead type. From the DSMS, rocket ripple can also be set between 1 and as many rockets you wish to launch per weapon release button press. Due to limited accuracy, it is best to ripple fire explosive warhead FFARs, but generally smoke and illumination FFAR are fired as singles.

Rockets can be delivered in both CCIP and CCRP delivery modes.

Average Length	1.2 m
Average Weight	8.4 kg (+ 2.7 kg for HE warhead)
Diameter	2.75 inch
Average Range	3,400 m
Rockets per pod	7
Motor	Mk 66
Motor burn range	397 m
Motor burn time	1.05 – 1.10 sec
Motor average thrust	1,330 – 1,370 lbs.
Launch velocity	148 fps

Unguided Bombs

Unguided bombs that the A-10C can employ fall into three categories: General Purpose (GP), Cluster, and Training:

General Purpose Bombs

Mk-82 LDGP

Developed in the 1950s as part of the Mk (pronounced Mark) 80 series of bombs, the Mk-82 is the most commonly dropped general purpose bomb by the A-10 and it provides good blast and fragmentation effects against unarmored and lightly armored targets. Weighing 510 lb. with 192 lb. of Tritonal high explosive, the Mk-82 can be mounted on TER and SER racks.

The standard Mk-82 is a low-drag "slick" bomb, also referred to as a Low Drag General Purpose (LDGP) bomb. The bomb is aerodynamically streamlined with four conical tail fins for flight stability. The bomb has a thin steel jacket that contributes to fragmentation effects.

The Mk-82 serves as the basis for several other bombs including the Mk-82AIR, GBU-12, GBU-38, and BDU-50(HD/LD/LGB).



Figure 46. MK-82 LDGP

Total Weight	510 lbs.
Explosive Weight	192 lbs.
Length	87.4 in
Diameter	10.75 in

Mk-82AIR

This version of the Mk-82 adds the BSU-49/B high drag tail assembly, also called the “ballute”. This allows the bomb to rapidly slow down after release. By slowing down, you can release such a retarded weapon at low altitude and not be caught in the blast effect of the weapon. You can choose to release the Mk-82AIR in either retarded or “slick” (no ballute deployed) modes. To drop as a slick, select only a nose fuze, and to release retarded, select nose/tail or tail fuze setting in the DSMS profile. The Mk-82AIR can be mounted on TER and SER racks.



Figure 47. MK-82AIR HDGP

Mk-84 LDGP

The Mk-84 is the big brother of the Mk-82 and it weighs 2,039 lb. with 945 lb. of H-6 or Tritonal high explosive. Although most effective against unarmored and lightly armored targets, the Mk-84 can also be effective against armored targets when dropped in close proximity. The Mk-84 can only be mounted on a SER.

As with the Mk-82, the Mk-84 has a thin steel casing with four conical stabilization fins mounted on the rear of the bomb. At impact, the bomb can create a crater measuring 50 feet across and 36 feet deep.

The Mk-84 forms the basis for other bombs including the GBU-10 and GBU-31 that the A-10C also carries.



Figure 48. Mk-84 LDGP

Total Weight	2,039 lbs
Explosive Weight	945 lbs
Length	129 in
Diameter	18 in

Cluster Bombs

CBU-87

The CBU-87 Combined Effects Munitions (CEM) weighs 950 lbs. and is an all-purpose cluster bomb. The SW-65 Tactical Munitions Dispenser contains 202 BLU-97/B Combined Effects Bomblets (CEB) and they are effective against armored and unarmored targets. The dispersal footprint of the bomblets depends on the Height of Function (HOF) and RPM spin setting in the DSMS/Inventory weapon configuration setting page. However, the general bomblet footprint coverage is 200 by 400 meters. The CBU-87 can only be mounted on a SER.

Each BLU-97/B CEB consists of a shaped charge, a scored steel casing, and a zirconium ring, for anti-armor and anti-personnel fragmentation and incendiary effects. Each CEB is designed to fragment into 300 fragments. Given the top attack angle of the weapon, the CEB can be effective against the generally light armor covering the top of an armored vehicle such as a tank.

CBU-97

The CBU-97 is a 1,000-pound class weapon containing sensor-fused sub-munitions for specifically attacking armor. This Sensor Fused Weapon (SFW) contains 10 BLU-108/B sub-munitions, and 40 “hockey puck” shaped skeet infrared sensing projectiles.



Figure 49. CBU-87 CEM

Total Weight	950 lbs
Warhead	202 BLU-97/B CEB
Length	92 in
Diameter	15.6 in

General Purpose Training Bombs

BDU-50LD

The BDU-50LD is the low drag (slick) training version of the Mk-82 but with an inert warhead. This bomb can be mounted on both TER and SER racks.



Figure 50. BDU-50LD

BDU-50HD

The BDU-50HD is the high drag training version of the Mk-82AIR but with an inert warhead. This bomb can be mounted on both TER and SER racks.



Figure 51. BDU-50HD

BDU-33

The BDU-33 is a miniaturized training bomb that mimics the ballistics of larger general-purpose bombs. The BDU-33 contains a small smoke charge to help round spotting.



Figure 52. BDU-33

Illumination Flares

The A-10C can drop illumination flares to illuminate a battlefield area for ground forces without benefit of night vision devices. The LUU-2 and LUU-19 series of flares are carried 8 a piece in the SUU-25 pod and are deployed one at a time using CCRP mode. After ejection, a programmable timer deploys a parachute and ignites the flare candle. Regarding the LUU-2, the flare burns magnesium and provides illumination over a 500-meter circular area when the flare is at 1,000 feet. The flare will burn for approximately 5 minutes.

The SUU-25 pod can be loaded on both SER and TER racks. It can be loaded on a single rack on stations 2, 3, 9 and 10 and on TERs on stations 3 and 9.

- **LUU-2B/B.** Visible-spectrum illumination.
- **LUU-19.** IR-spectrum illumination that aids night vision devices.



Figure 53. Deployed LUU-2B/B



Figure 54. SUU-25 Canister

Illumination flares can only be released in Manual Release mode using CCRP. If in CCIP, you will be given a HUD message to switch to CCRP.

Laser Guided Bombs

The A-10C can employ Laser Guided Bombs (LGB) by either self-designating the target with its own targeting pod or allowing another air or ground unit to laser designate the target for an LGB attack. Either way, the basics of an LGB delivery are roughly the same.

When buddy-lasing for another aircraft, it will be important to note that both the designating aircraft and the aircraft dropping the LGB are set to the same laser code. The laser code is set in the Control Page of the A-G targeting pod mode.

The two types of LGB available for the A-10C are:

GBU-10 Paveway II

This Guided Bomb Unit (GBU) weighs 2,562 lbs. and is basically a laser-guided version of the Mk-84 unguided bomb with a general-purpose warhead. The laser detector on the nose of the bomb detects the reflected energy of the designating laser at the set laser code. Once dropped, the wing-like airfoil surfaces at the rear of the bomb extend and are used to maneuver the bomb to the laser designation point. Rather than smooth and constant input of course-corrections to reach the target, the bomb uses a series of discreet input corrections and this is often referred to as "bang bang" guidance mode.

GBU-10 can only be hung from a single ejector rack on stations 3, 4, 5, 7, 8, and 9.

Suitable targets for the GBU-10 are large and/or hardened targets that require an accurate and powerful strike. Such targets often include bridges, bunkers, and hardened command posts.



Figure 55. GBU-10 LGB

Total Weight	2,081 lbs
Explosive Weight	945 lbs
Length	170 in
Diameter	23 in (includes airfoils)
Glide Range	8 nm
Impact Accuracy	Within 9 m

GBU-12 Paveway II

This GBU is the laser-guided version of the Mk-82 unguided, general purpose bomb. The GBU-12 guides using the same principles as the GBU-10, the only difference being the bomb the LGB is based on. Given the ability to carry three GBU-12s per TER, the A-10C can carry many of these bombs for pinpoint attacks. During Operation Desert Storm, for example, F-111 bombers used GBU-12 to great effect, “plinking” Iraqi tanks sitting static in the desert. A direct hit from a 500 lb-class bomb will destroy even the most heavily armored tank every time!

This bomb can be loaded on both single ejector racks on stations 1, 2, 3, 4, 5, 7, 8, 9, 10, and 11, and on Triple Ejector Racks (TER) on stations 3, 4, 8, and 9.



Figure 56. GBU-12 LGB

Total Weight	611 lbs.
Explosive Weight	192 lbs.
Length	131 in
Diameter	18 in (includes airfoils)
Glide Range	8 nm
Impact Accuracy	Within 9 m

BDU-50LGB

The BDU-50LGB is the training version of the GBU-12 with the only difference being an inert warhead and the casing being colored blue (standard color for training ordnance).

Inertially Aided Munitions (IAM)

The A-10C can carry two types of Inertially Aided Munitions (IAM): Global Positioning System (GPS) guided and Inertial-guided system (INS) guided. These bombs use a coordinate position (SPI in the A-10C case) downloaded into the guidance system of the bomb, and once released, the bomb will correct its flight path to impact at the coordinate which is also the SPI. Although these weapons can be useful against static targets, they are useless against moving ones.

IAMs can only be mounted on the six 1760 smart stations of the A-10C: 3, 4, 5, 7, 8, and 9 on single ejector racks.

GBU-38

The GBU-38 is a standard Mk-82 general purpose bomb fitted with a GPS guidance kit. This kit, referred to as the Joint Directed Attack Munition (JDAM) kit, turns an ordinary Mk-82 into a precision guided munition with a significant stand-off glide range. The kit consists of the GPS antenna on the rear of the bomb, actuated tail surfaces to steer it, and strakes along the body of some JDAM versions (not so with the GBU-38). As long as the bomb can be provided adequate GPS signal, it can strike within 33 feet of inputted target coordinates day or night and in most any weather. This ability to strike targets through clouds and weather gives it a significant advantage of laser-guided bombs.

For the A-10C, the Sensor Point of Interest (SPI) can be set as the target point for a JDAM attack.

GBU-38 can only be loaded one per station on the 1760 smart stations.



Figure 57. GBU-38 IAM

Total Weight	558 lbs
Explosive Weight	192 lbs
Length	92.64 in
Diameter	10.75 in
Glide Range	8 nm
Impact Accuracy	Within 33 feet

GBU-54

The GBU-54 is a Mk-82 bomb with both an INS/GPS and laser-guidance kit, LJDAM. This allows the weapon to engage targets in conditions that laser-guidance is not possible, and precision laser-guidance against even moving targets.



Figure 58. GBU-54

Total Weight	558 lbs.
Explosive Weight	192 lbs.
Length	92.64 in
Diameter	10.75 in
Glide Range	8 nm
Impact Accuracy	Within 33 feet

GBU-31

The GBU-31 is a standard Mk-84 general purpose bomb fitted with a JDAM guidance kit. Unlike the GBU-38 though, the GBU-31 has the strakes along the sides of the bomb to improve flight characteristics.



Figure 59. GBU-31 IAM

Total Weight	2,085 lbs
Explosive Weight	945 lbs
Length	148.6 in
Diameter	14.5 in
Glide Range	8 nm
Impact Accuracy	Within 33 feet

CBU-103

The CBU-103 is a standard CBU-87 cluster bomb fitted with an INS guidance kit to form a Wind Corrected Munition Dispenser (WCMD). Unlike the GBU-31 and GBU-38, a WCMD (pronounced "Wick Mid") does not use GPS guidance. Rather, the WCMD system uses the aircraft's inertial navigation system to "know" its current location and the location of the target, and then use the tail kit to steer the bomb to the target location. This provides an inexpensive means to deliver CBU systems at medium to high altitudes accurately.

The CBU-103 marries a CBU-87 with a WCMD guidance kit.

CBU-105

The CBU-105 is the Wind Corrected Munitions Dispenser (WCMD) tail kit version of the CBU-97. Using Inertial Navigation System (INS) guidance, the CBU-105 can be dropped at much higher altitudes than the CBU-97 and guide to the targeted location (SPI).



Figure 60. CBU-105 IAM

Total Weight	950 lbs
Explosive Weight	945 lbs
Length	148.6 in
Diameter	14.5 in
Glide Range	8 nm
Impact Accuracy	Within 30 feet

AGM-65 Maverick

The AGM-65 Maverick is a precision-guided, stand-off air-to-ground missile that is best suited against armored, air defense, and fortified targets. The Maverick can only be loaded on stations 3 and 9 and either from the LAU-117 single rail launcher or the LAU-88 triple rail launcher. The Maverick includes several different versions that differ in seeker type and warhead type. Each version also has a training version (designated TGM or CATM).

The Maverick is a fire-and-forget weapon, meaning, once launched you no longer need to guide the weapon. The exception is the AGM-65L laser-guided version that will require the host-aircraft targeting pod to designate the target the entire time of missile flight. Practical engagement range of the Maverick is generally restricted by seeker lock on range, and this generally happens between 3 and 7 nm. When attacking a target area, you may wish to first use Maverick to eliminate any air defense units from a distance first.



Figure 61. Maverick Launch

Maverick versions include:

- **AGM-65D.** Imaging infrared seeker with 125 lb. shaped warhead. Can be loaded on LAU-117 or up to three on a LAU-88.
- **AGM-65G.** Imaging infrared seeker with 300 lb. heavyweight penetrator warhead. Can only be loaded on LAU-117.
- **AGM-65H.** Electro-optical seeker with 125 lb. shaped warhead. Can be loaded on LAU-117 or up to three on a LAU-88.
- **AGM-65K.** Electro-optical seeker with 300 lb. heavyweight penetrator warhead. Can only be loaded on LAU-117.
- **AGM-65L.** Laser-guided seeker with 300 lb. heavyweight penetrator warhead. Can only be loaded on LAU-117.

- **TGM-65D.** Training version of AGM-65D with inert rocket motor and warhead. Can be loaded on a LAU-117.
- **TGM-65G.** Training version of AGM-65G with inert rocket motor and warhead. Can only be loaded on LAU-117.
- **CATM-65K.** Training version of AGM-65K with inert rocket motor and warhead. Can only be loaded on LAU-117.
- **TGM-65H.** Training version of AGM-65H with inert rocket motor and warhead. Can be loaded on a LAU-117.



Figure 62. AGM-65D



Figure 63. AGM-65B/K



Figure 64. TGM-65D

Weight	485 lbs. (D and H) and 670 lbs. (G and K)
Diameter	12 in
Length	2.5 m
Speed	1,150 km/h
Range	17+ miles

Advanced Precision Kill Weapon System

The Advanced Precision Kill Weapon System, or APKWS (also designated the AGR-20A), combines a 2.75-inch rocket with laser-guidance for pinpoint accuracy against unarmored and lightly armored targets. The small warhead is also idea to avoid collateral damage.

The APKWS can engage targets based on the laser-designation from the A-10C targeting pod, and this also allows engagement of moving targets.

The rockets are housed in a standard LAU-131 rocket pod, and up to three such pods can be loaded on LAU-88 weapon racks.

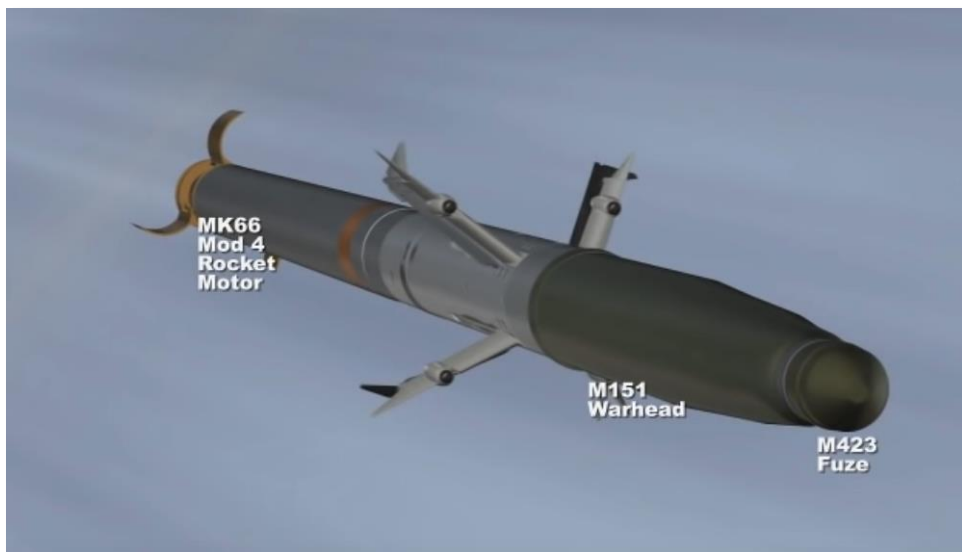

Figure 65. APKWS / ARG-20A

Weight	32 lbs.
Diameter	2.75-inches
Length	73.8-inches
Speed	3,600 km/h
Range	1.2 to 6.8 nm

AIM-9M / CATM-9M Sidewinder

Although the A-10C is not designed for air-to-air combat, it does have capabilities for air-to-air self-defense and can engage the hapless enemy helicopter that strays too close. Air-to-Air weapons of the A-10C include the 30 mm gun in Air-to-Air mode and the AIM-9M Sidewinder Air-to-Air Missile. The A-10C does not include any sort of radar, so using these weapons is based on visual aiming and acquiring targets with the targeting pod if desired.

In addition to the AIM-9M Sidewinder, the A-10C can also carry the CATM-9M training missile. This store has the same seeker as the AIM-9M, but the rocket motor and warhead are inert.

Both the AIM-9M and the CATM-9M are mounted on the Dual Rail Adapter (DRA) which can be mounted only on stations 1 and 11.

The AIM-9 uses an infrared detector in the nose of the missile to detect and track the infrared energy of targets. As such, target aircraft that are in afterburner or have a larger infrared signature are more easily detected and tracked. However, some target aircraft may deploy infrared countermeasure flares that will attempt to decoy the missile.



Figure 66. AIM-9M Sidewinder

Length	2.85 m
Diameter	127 mm
Weight	91 kg
Range	1- 18 km
Speed	Mach 2.5

TK600 External Fuel Tanks

The TK600 external fuel tank carries 600 gallons of fuel and can be carried on stations 4, 6 and 8. The fuel tank is unarmored and has no self-sealing capability. As such, this fuel tank is only carried during ferry missions and is never flown with in combat.



Figure 67. TK600 External Fuel Tank

AN/AAQ-28 Litening AT Targeting Pod

The Litening AT targeting pod incorporates both a daytime Charged Coupled Device (CCD) TV camera and a Forward Looking Infrared (FLIR) camera that are used to acquire and track targets day and night. Also built into the pod is a laser designation and ranging system and an infrared pointing device (IR Pointer). The pod can also detect laser illumination and track it in the Laser Spot Search and Laser Spot Track (LSS/LST) modes.



Figure 68. AAQ-28 Litening AT

In addition to the air-to-ground (A-G) mode of operation, the pod can also be placed in air-to-air (A-A) mode and be capable of acquiring and automatically tracking air targets. Once tracked, the AIM-9M air-to-air missile can automatically have its seeker slewed to it.

The Litening pod allows you to acquire targets at long range at day or night and to cue the designation point as the Sensor Point of Interest (SPI). Additionally, you can use the pod to laser designate a target for another aircraft to drop a laser-guided bomb on. The pod is a very powerful device but is best used above 10,000 feet to take advantage of its sight range.

The pod can either be hung on station 2 or 10, and this is often a visible means to identify an A-10C compared to an A-10A in which the pod is hung on station 3 or 9.

Length	2.20 m
Diameter	0.406 m

Weight	200 kg
---------------	--------

MXU-648 Travel Pod

Although this container has seen a broad range of uses over the years over a wide range of aircraft, for the A-10C it acts as a travel pod when the aircraft is deployed. The pod generally contains such items as intake covers, wheel chocks, and pin flags. This pod would never be carried in a combat mission.



Figure 69. MXU-648 Travel Pod

Carry Weight	234 lbs.
Diameter	26.5 in
Length	183 in

General and Performance Characteristics

First flight (YA-10), year	May 10, 1972
Crew	1
Powerplant	
Type	2x TF34-GE-100A
Power	39.6 kN each
Dimensions, ft in	
Length	53 ft 4 in
Wingspan	57 ft 8 in
Height	14 ft 8 in
Wheelbase	17 ft 9 in
Weights, lbs.	
Empty	24,959
Standard (internal fuel, full gun load, and pilot)	30,782
Max	51,000
Fuel, gals	
Internal fuel	1,630
External fuel (3x TK600 external fuel tanks)	1,800
Speed, kts	
Stall speed	120
Max not to exceed speed at S/L	450
Cruise speed	300
Ceiling, ft	
Service ceiling	45,000
Rate of climb ft/min	6,000
Design G limit (300 – 450 kts) at sea level	+7.3 / -3.0
Range, nm	
Combat Range	252
Ferry Range	2,240

COCKPIT CONTROLS



COCKPIT CONTROLS

Instrument Panels Overview

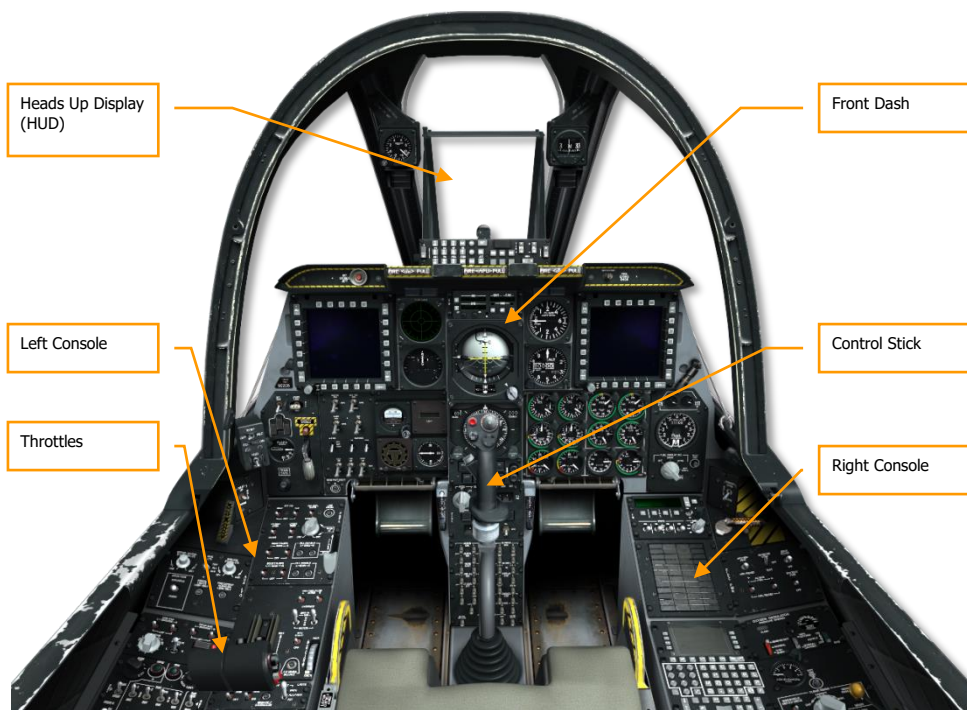

Figure 70. A-10C Cockpit

The cockpit of the A-10C contains three primary instrument panels that include gauges and indicators that display flight parameters, aircraft system states, engine state, control positions, and system warnings. Owing to the single-pilot operation of the A-10C cockpit, all flight and weapon system controls must be readily accessible to the pilot. This has led to a rather crowded cockpit that at first can seem quite intimidating! However, with practice and a study of this manual, the cockpit will soon feel like your home office. With the addition of two Multifunction Color Displays (MFC), many of the

operations have been streamlined and simplified compared to the older A-10A model. However, a study of the many MFCD pages and HUD modes will be a must.

In this manual, the first several chapters are devoted to reference data on all the various systems. The second half of this manual will walk you through how to operationally use these functions. You may wish to cross reference back and forth between chapters to best understand a system and its operational functionality.

Many of the controls in the cockpit have pop-up tool tips displayed when the mouse is hovered over them. This can be useful when trying to remember the many control functions within the cockpit. These tool tips can be toggled off and on from the options menu.

Using your mouse, you may manipulate many of the controls. This can include:

- Left mouse click to toggle a switch or button
- Left or right mouse click to rotate a rotary dial
- Rotate the mouse wheel to spin a knob
- Left click and drag to spin a knob

When the mouse is placed over a control that can be manipulated, the cursor will turn green and provide you an icon to indicate the type of possible action. All of the mouse click functions also have keyboard press equivalents; these can be reviewed in your keyboard input control list. These keyboard commands are listed in blue within this manual.

Let's do a walk-around of the primary areas of the cockpit:

The primary flight instruments are located on the front dash, beneath the Heads-Up Display (HUD).

Control Stick

The primary function of the control stick is to provide pitch and roll commands to maneuver the aircraft. Pushing and pulling on the stick affects aircraft pitch (moves the elevators) and moving the stick from side-to-side inputs roll (moves the ailerons).

Note that you can also use the trim hat to adjust pitch and roll stick neutral settings.

The stick has several buttons and hats that allow you to manipulate the various systems of the A-10C without having to take your hands off the stick. The A-10C stick differs from the older A-10A stick that was based on the control stick of the F-4 "Phantom II". The A-10C stick on the other hand is based on

the F-16 "Viper" stick. However, unlike the side-mounted F-16 stick that is pressure based and barely moves, the A-10C stick is a full-motion stick that is centrally mounted like the A-10A stick.

Depending on selected Sensor of Interest (SOI), many of the stick switches and buttons can have multiple functions. The most common means to set the SOI is by use of the Coolie Hat on the throttles. Possible SOI may include:

- Tactical Awareness Display (TAD)
- Targeting Pod (TGP)
- Heads Up Display (HUD)
- AIM-9 Air-to-Air Missile
- AGM-65 Maverick Air-to-Ground Missile (MAV)

Additionally, many of the buttons and switches have alternate functions if they are held down for a Short period or a Long period (1 second or more). These include:



Figure 71. Control Stick

Hotas Commands - Stick

Stick	Action		Selected Sensor Of Interest							
			TAD	TGP	HUD	A-A	MAV	HMCS	HMCS B/S	MSG
MMCB	D'press	Short	Toggle HUD							
		Long	Enter A-A							
DMS	FWD	Short	TAD Scale Decrease	Zoom Increase Focus Increase	Steerpoint Increment	Steerpoint Increment	Mav BS Rect UP	Brightness Increase	Text Rotate CCW	Change Shape
		Long	Map Quick Toggle							
	Aft	Short	Tad Scale Increase	Zoom Decrease Focus Decrease	Steerpoint Decrement	Steerpoint Decrement	Mav BS Redticle Down	Brightness Decrease	Text Rotate CW	
		Long	Select TAD Centre Option							
	Left	Short	CEN/DEP Mode CNTR Own	R MFCD Video on HMD	Gunsight Toggle Profile Toggle	Gunsight Toggle Profile Toggle	Mav BS Rect. Left	R MFCD Video on HMD	Boresight Roll CCW	HMD On/Off
		Long	HMD On/Off							
	Right	Short	Cycle TAD Centre Option	Laser/R Pointer Toggle	Gunsight Toggle Profile Toggle	Gunsight Toggle Profile Toggle	Mav BS Rect. Right	Cycle HMCS Profiles	Boresight Roll CW	Slave TGP to HMCS
		Long	Slave TGP to HMCS LOS				Slave Mav to HMCS	Slave TGP to HMCS		
	TMS	FWD	Short	Hook Symb Under Cursor	Area / Point / NR track	TDC Ground Stabilise	Conical Scan	Track	Hook Symb. Under Crosshair	Comp. BS/sett Occl Pt.
			Long	Make Hooked obj. SPI	Make SPI				Make Hooked obj. SPI	Complete Occl Pt.
Aft		Short	Un-Hook Symbol	FLIR Auto Focus	IFFCC Wpns sol. SPI	Break Lock	Ground Stabilise	Un-Hook Symbol	Remove Occl. Pt.	
		Long	Reset SPI to Current Steerpoint							
Left		Short	Acknowledge W/C/N (includes message receipt acknowledgement)							
		Long	SPI Broadcast							
Right		Short	Mark at TAD Cursor	Mark at TGP LOS	Mark at TDC	Mark at TDC	Mark at Mav LOS	Mark at HDC		
	Long	Make last markpoint SPI								
NWS	Ground	NWS Engage/disengage								
	Air	Laser/R Pointer HOT Fire and Toggle Fire								
	AR	AR Disconnect / Reset								
CMS	Fwd	Short	1 Flare							
		Long	Next Program							
	Aft	Short	1 Chaff							
		Long	Previous Program							
	Left	Short	6 Flares							
		Short	6 Chaff							
	Depress	Short	Activate/Deactivate Selected Program							
Long		Activate/Deactivate ECM								

Note: The Precision Attitude Control (PAC) system can be assigned to a single stage trigger to be enabled when the cannon is fired. If you have a two-stage trigger joystick, you may assign PAC to the first stage and cannon fire to the second stage.

If you have a programmable control stick at home, you may wish to program it to match these settings. You can do so using the input control manager in the options screen.

Throttles

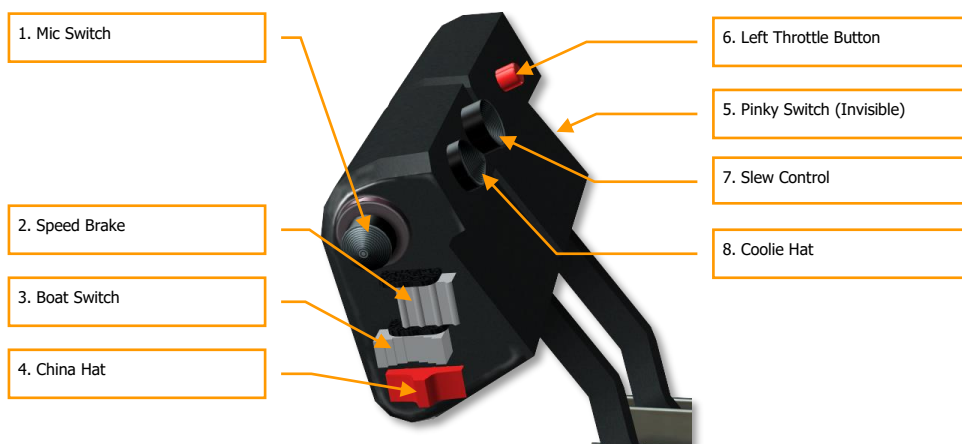

Figure 72. Throttles

The throttles are your primary means of controlling the thrust of your two TF-34-GE-100A engines. If you want to increase thrust, push the throttles forward and if you want to decrease thrust pull them back. When both the left and right throttles are all the way back, the engines are shut down (OFF). However, moving them forward and over the “hump”, it will initiate the auto-start (assuming other startup steps are first accomplished) and the engines will be at IDLE power.

The left throttle is the same left throttle as found in the older A-10A and the right throttle is taken from the F-15E “Strike Eagle”.

- Linked throttles up
- Linked throttles down
- Left throttle up
- Left throttle down
- Right throttle up
- Right throttle down

On the throttles are several switches and buttons that allow you to control aircraft systems. Like the control stick, the function of a switch or button will often vary according to the selected Sensor of Interest (SOI). The most common means to set the SOI is by use of the Coolie Hat on the throttles.

Also like the control stick, the time duration an input is made (Short or Long) can determine the output function of the control. The throttles' functions are as follows according to SOI:

HOTAS Commands - Throttle

Throttle	Action		Selected sensor of interest								
			TAD	TGP	HUD	A-A	MAV	HMCS	HMCS B/S	MSG	
Mic Switch	Fwd	VHF AM radio transmit (when audio rotary in "VHF")									
	Aft	VHF FM radio transmit									
	Up	No function									
	Down	UHF radio transmit									
Speed Brake	Fwd	Retract speedbrakes									
	Aft	Extend speedbrakes									
	Center	Hold speedbrake position									
Boat Switch	Fwd	TGP FLIR black hot				Maverick black hot		TGP FLIR black hot			
	Aft	TGP FLIR white hot				Maverick white hot		TGP FLIR white hot			
	Center	TGP CCD				Maverick force correlate mode		TGP CCD			
China Hat	Fwd	Short	Toggle FOV	Change LSS FOV	Show Maverick video / SOI to Maverick	Uncage / consent to self-track	Change FOV	Change TGP or LSS FOV			
		Long	Slave all to SPI								
	Aft	Short	Reset cursor	Toggle LSS	Cage TDC to TVV	Re-cage / manual sequence	Re-cage / manual sequence	Cage HDC to crosshairs			
		Long	Slave TGP to current steerpoint								
Pinky Switch	Fwd	Position lights dim and steady, strobes off									
	Aft	Exterior lights according to lighting panel									
	Center	All exterior lights off									
Left Throttle Button	Press	Short	LAAP								
Slew/Track	Slew	Slew cursor	Slew seeker head	Slew TDC	Slew seeker head	Slew seeker head	Slew HDC	Slew boresight	Slew cursor		
	Z-axis										
Coolie Switch	Up	Short	SOI to HUD								
		Long	Messages quick-look								
	Down	Short	SOI to HMCS								
		Long	DSMS weapon status and profile pages quick-look								
	Left	Short	Cycle left MFCD page								
		Long	SOI to left MFCD								
Right	Short	Cycle right MFCD page									
	Long	SOI to right MFCD									

Front Dash

The forward area of the cockpit consists of a variety of instruments, gauges, displays and controls. The front dash is divided into four primary areas: left, center, right, and top. We'll discuss each of these in detail.

Left Front Dash

The left forward panel is primarily dedicated to various flight control gauges and warning systems. While most of the primary flight information will be displayed on the heads-up display (HUD), the analog gauges can provide a valuable backup and provide additional information not present on the HUD.

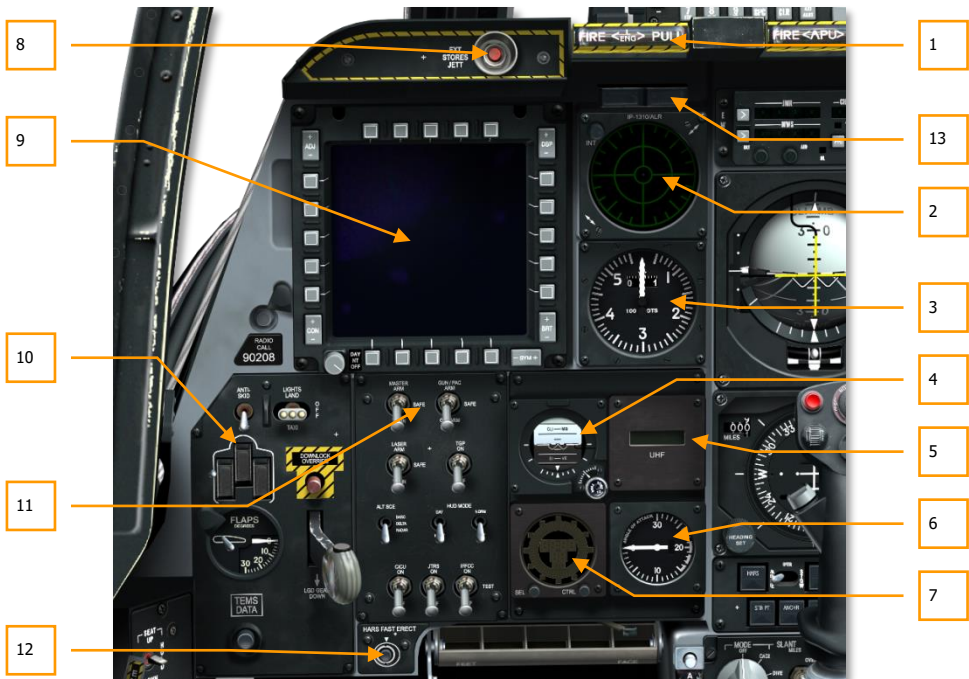

Figure 73. Left Front Dash

1. Left engine "T Handle" fire extinguisher discharge select
2. Radar Warning Receiver (RWR) display
3. Airspeed indicator
4. Standby Attitude Indicator (SAI)
5. UHF frequency repeater
6. Angle of Attack (AoA) indicator
7. Digital clock

8. Emergency stores jettison button
9. Left Multifunction Color Display (MFCD)
10. Landing gear and flap control panel
11. Armament HUD Control Panel (AHCP)
12. Heading Attitude Reference System (HARS) fast erect switch
13. Gun arm and nose wheel steering lights

Left Engine "T-Handle" Fire Extinguisher Discharge Select



Figure 74. Left T-Handle

This "T" shaped handle is located below the HUD on the left side of the front dash. When a fire is detected in the left engine, the handle will light indicating a fire there. By pulling a T-Handle, you designate where fire extinguisher agent will be sent to after pressing the fire extinguisher discharge switch.

Radar Warning Receiver (RWR) Display



Figure 75. Radar Warning Receiver

The azimuth indicator is a circular-shaped display that provides you a visual representation of radar emitters around your aircraft. This display will also provide azimuth of detected missile launches. Please reference the Defensive Systems chapter to learn about this display in detail.

Airspeed Indicator



Figure 76. Airspeed Indicator

Displaying indicated airspeed in units of 100 knots, and with a maximum indication of 550 knots, this gauge is divided into increments (tick marks) of 10 knots. The solid-white pointer indicates current airspeed and the black and white striped pointer indicates maximum airspeed according to altitude. The rotary drum indicates decimals of main dial.

1. Current Airspeed
2. Maximum Speed
3. Decimals rotary

The yellow line at 200 knots represents the maximum flap and gear extension speed.

Standby Attitude Indicator (SAI)

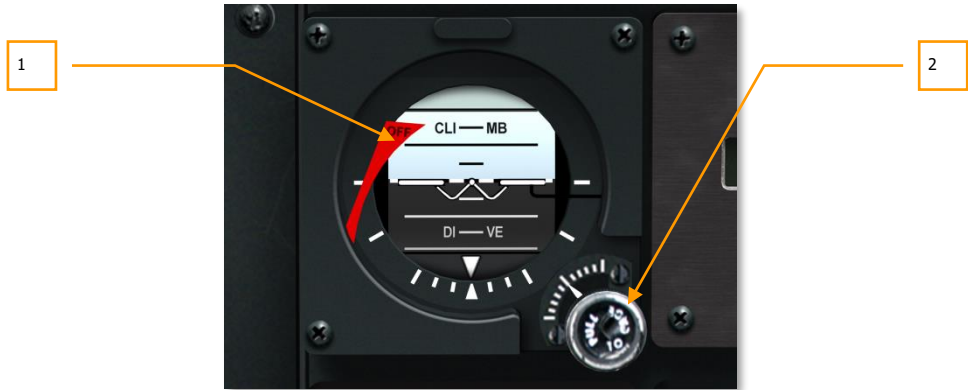

Figure 77. Standby Attitude Indicator

Mirroring the basic function of the ADI, this backup serves as independent attitude verification. An OFF warning flag appears on the left side of the gauge if no power is applied or the gauge has been caged.

A knob labeled PULL TO CAGE is located to the lower right of the gauge and allows you to cage the gauge by pulling it or you may rotate it to adjust the level pitch angle.

1. OFF Warning Flag
2. Cage Knob

UHF Frequency Repeater



Figure 78. UHF Repeater

The preset UHF frequency on the AN/ARC-164 UHF radio control head is repeated on this indicator.

Angle of Attack Indicator



Figure 79. Angle of Attack Indicator

Angle of attack measures the difference between the longitudinal axis of the aircraft and the relative wind. The A-10C measures this with a vane on the wings.

The angle of attack gauge displays this angle as an indication between 0 and 30 units with each tick mark on the gauge as one unit. The pointer, extending from the center of the gauge, points to the current angle of attack except when no power is applied. When the gauge is not powered, a red OFF flag is displayed on the right side of the gauge. With no power, the pointer defaults to 0 units.

1. Current angle of attack
2. OFF warning flag (not pictured above)

Digital Clock



Figure 80. Digital Clock

The clock has a digital readout in HH:MM:SS format where the seconds are displayed on the bottom. A digital second hand also rotates depicting seconds on the periphery of the display.

Two pushbuttons on the front face of the clock are used to select the desired operating mode. The buttons are labeled "SEL" for select and "CTRL" for control. These buttons have various functions:

- CLOCK MODE (default) displays current time, as indicated by a "C."
- ELAPSED TIME MODE displays elapsed time counting upward from 00:00:00, as indicated by an "ET" in the display

Clock mechanization works as follows:

- When in Clock Mode, the SEL button switches to Elapsed Time Mode
- When in Elapsed Time Mode, the SEL button switches to Clock Mode
- When in Clock Mode, the CTRL button has no function

When in Elapsed Time mode, the CTRL button is used to start, stop and reset the timer. The first press starts the timer, the second press stops the timer, and a third press resets the timer to zero.

1. Select Button
2. Control Button

Emergency Jettison Button



Figure 81. Emergency Jettison Button

To immediately jettison all stores (excluding the Targeting Pod and ECM pod) on stations 1 through 11, you may press the EXT STORES JETT button located in the top left portion of the front dash. Once pressed, and regardless of landing gear handle position, all stores will be released in station priority order.

Left Multifunction Color Display (MFCD)

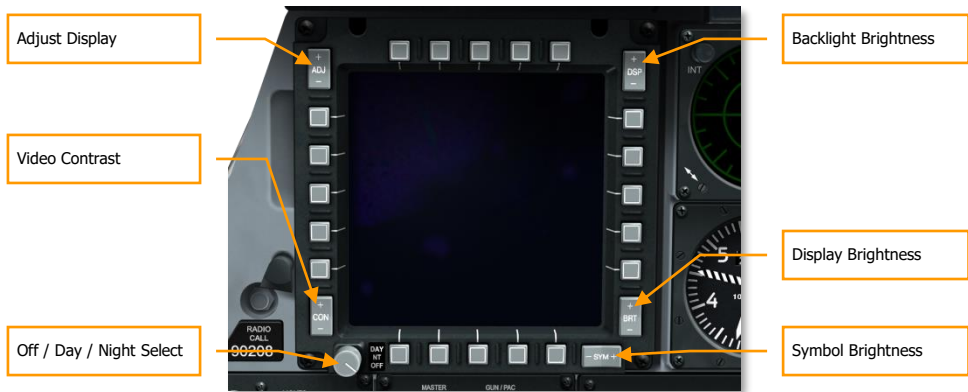

Figure 82. Multifunction Color Display (MFCD)

The A-10C contains two Multifunction Color Displays (MFCDs) that allow display of multiple system pages (DTS, TAD, DSMS, etc.). Information displayed on the MFCDs is derived from the Central Interface Control Unit (CICU). As such, the MFCDs are activated and deactivated by the CICU toggle switch on the Armament HUD Control panel (AHCP). Please refer to the MFCD Pages Chapter for further details about the MFCD.

Each MFCD is 5x5 inches and has five Option Select Buttons (OSB) on each of the four sides (20 total). These OSB will have various functions depending on the MFCD page and page function.

- OSBs 1 – 5 are along the top of the MFCD
- OSBs 6 – 10 are along the right side of the MFCD
- OSBs 11 – 15 are along the bottom of the MFCD
- OSBs 16 – 20 are along the left side of the MFCD

To activate a button, you may either left mouse button click on it or press the assigned keyboard key.

Each OSB is also Tool Tip context sensitive, and you will receive a tool tip of the OSB function when you hover the mouse cursor over it.

Attitude Reference Symbol (ARS)

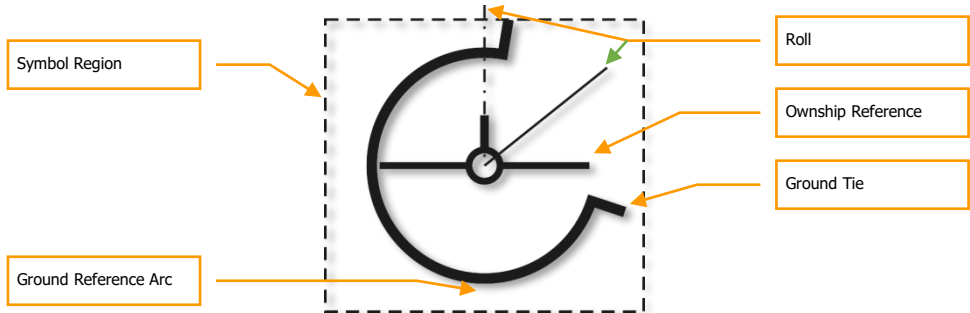

In the lower left corner of each MFC is the Attitude Reference Symbol (ARS). It provides you an indication of the aircraft's current pitch, roll and barometric altitude. The ARS symbol is composed of three primary components:

Ownship reference. This is a static symbol that always stays in the center of the ARS with the aircraft longitudinal axis represented by the circle in the center of the symbol. The vertical line mark represents the vertical stabilizer, and the two horizontal lines represent the wings. The ground reference arc revolves around this symbol to denote pitch and bank angle.

Ground reference. The arc portion of the display is the "ground" portion and is like an ADI indicator. During level flight, an equal amount of ground and sky is seen; as such, the arc represents 180° . However, during a 45° bank, you still see a full 180° arc, but it is rotated 45° . If the aircraft is diving, the indicator displays increasingly more ground as the dive pitch increases. Consequently, the arc increases in size above 180° the greater the dive angle (360° in a 90° dive). If the aircraft is nose up, the arc will decrease in size according to the nose-up angle (no arc would be displayed at a 90° climb angle).

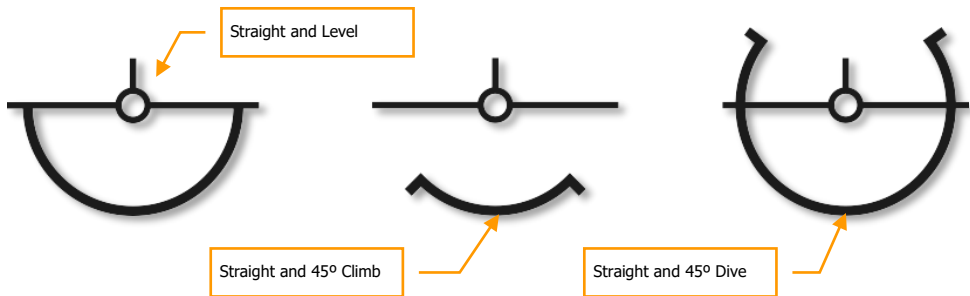

Ownship Altitude. In the lower left corner of the symbol field is the barometric altitude. The first two large digits represent thousands of feet and the small digit to the right indicates hundreds of feet. For example, "025" indicates 2,500 feet.

Declutter

Several of the MFC D pages have a Declutter option. The Declutter (DCLT) OSB allows you to remove the OSB legends 1 through 10 and OSB legends 16 through 20 on the Targeting Pod (TGP), Tactical Awareness Display (TAD), and Maverick MFC D pages. This allows you a more unobstructed view of these pages.

The Declutter is assigned to OSB 11 by default.

If the DCLT OSB is selected and Declutter is active on the selected page, the "DCLT" legend is displayed in reverse video. This indicates that Declutter is active. Pressing DCLT a second time disables the Declutter function and the "DCLT" legend will appear normally (in non-reversed video).

Additional rules regarding the Declutter function:

- Even if a page is decluttered and the removed legends are not visible, the OSBs still function according to their assignment. Tool tips associated with those OSBs will still function as well.
- Declutter of a page only applies to the selected page and not others; each page can be decluttered independently. This includes having the same page on both MFC Ds (one MFC D can have the page decluttered and the other not).
- The Declutter state of a page is saved. This means that if you declutter a page, go to another page, and then comes back to the original page, the original page will remain decluttered.
- Performing a Declutter or deactivating Declutter in a Family of pages applies the function to all pages within the Family. Family pages include:
 - All TGP pages
 - Maverick video page
 - All TAD pages

Swap

The Swap function allows you to exchange the contents of the left and right MFCDs. When displays are swapped, however, the selected SOI will not change.

To initiate a Swap, the user uses the SOI select Coolie Hat Down Short command.

OSB Symbol Characters

Next to an OSB may be a symbol character that represents a process function that the OSB will perform when pressed. These can include cycling of selections, data entry, system action, etc. Only one OSB may ever be selected at one time; selecting one OSB automatically deselects an already selected OSB.

When an OSB is selected, the label is displayed in reverse video.

There are six types of OSB symbol characters:

- **Data Entry.** This character type “[]” allows you to enter data from the Control Display Unit (CDU) or Up Front Controller (UFC) scratchpad and enter it into the system. This can include both alphanumeric or a string of numbers. If the data entered is valid, the scratchpad is cleared upon entry; if that data is invalid, however, an error indication is placed on the scratchpad (see UFC section). If the CDU is unavailable, data entry is not possible. Once the data is entered into the scratchpad, a press of the ENTER button on the UFC or CDU saves the data entry.
- **Rotary.** This type allows you to cycle through a series of values in a preset order. Each press of the Rotary OSB cycles to the next specified value. If the last value is selected and the Rotary OSB is selected, the first value will be displayed (the values will “wrap”). If the Rotary OSB is held down for more than 0.5 seconds, then the values will automatically cycle at every three seconds or until the OSB is no longer pressed. The selected value will not take effect until 1/2 second after the Rotary OSB has been released.
- **Increment/Decrement.** This character type denotes the ability to use the +/- controller on the UFC to cycle through a series of values. In order to enter values in this manner, the Increment/Decrement OSB must be selected first. To deselect such an OSB, press it a second time, select a different OSB, or switch to a different page. When an Increment/Decrement OSB is selected, the character (symbol) will be displayed in reverse video.
- **System Action.** This type of character informs you that pressing the OSB will command a specified action, generally indicated by the OSB label.

- **Branch.** Indicated as either a left or right pointing arrow, OSBs with this character will direct to a different page when pressed.
- **Navigation.** This OSB action type is denoted by the up and down pointing, solid arrows next to the OSB. This OSB function allows you to cycle values in two directions (up and down). This function is similar to the Increment/Decrement function but does not rely upon the UFC to cycle data values; it can be done on the MFCD.

MFCD Physical Display Controls

Around the MFCD bezel are 5 rocker switches that control aspects of the display:

- **Brightness (BRT).** Rotating this knob will control the brightness of the display.
- **Video Contrast (CON).** No function.
- **Display Entity Levels (SYM).** No function
- **Backlight Brightness (DSP).** No function.
- **Adjust Display (ADJ).** When TAD page is active, the + and – ends of the rocker can be used to zoom and un-zoom the map display when in Manual Map Control Mode.

In addition to the rocker switches, a 3-position switch is in the lower left portion of the bezel. This switch has 3 positions:

- **DAY.** Day illumination of MFCD.
- **NT.** Night illumination of MFCD.
- **OFF.** Disable power to MFCD.

Landing Gear and Flap Control Panel

The A-10C has tricycle-configuration landing gear that is controlled by the landing gear handle or the auxiliary landing gear extension handle in an emergency. Landing gear extension and retraction is normally powered by the left hydraulic system. In the event of left hydraulic system failure, the auxiliary handle, which uses the right hydraulic system, can be used and it requires no electrical power. If, however, both hydraulic systems are inoperative, the landing gear locks can be released and gravity and aerodynamic forces will likely extend the landing gear.

The landing gear handle is circular-shaped and has a LGD GEAR DOWN label beneath it. When the handle is in the down position, it indicates that landing gear is extended. For the handle to be moved to the up position (raise landing gear), when DC power is available, there must be no weight-on-wheels, or the Downlock Override button must also be depressed.

If the landing gear handle is down, the aircraft is traveling 145 KIAS or less, one or both throttles are at max power and the speed brakes are extended, an audio "Speed brakes, speed brakes" message will be heard.

In the handle of the landing gear is a red lamp. This lamp will turn on when the landing handle is moved from down to up until the landing gear is locked. It will also light when the landing gear is locked after moving it from the up to the down position.

Immediately to the left of the Downlock Solenoid Override button, three lights indicate the current position of the landing gear. These three lights represent the three wheels of the aircraft: the two main wheels and the nosewheel. The two main wheel lights are labeled L/R SAFE and the nosewheel light is labeled N SAFE. When one of the wheels is down and locked, the representative light will turn green. When a wheel is up and locked, the representative light will not be lit.

During landing gear transit time, an audio gear warning tone will also be heard.

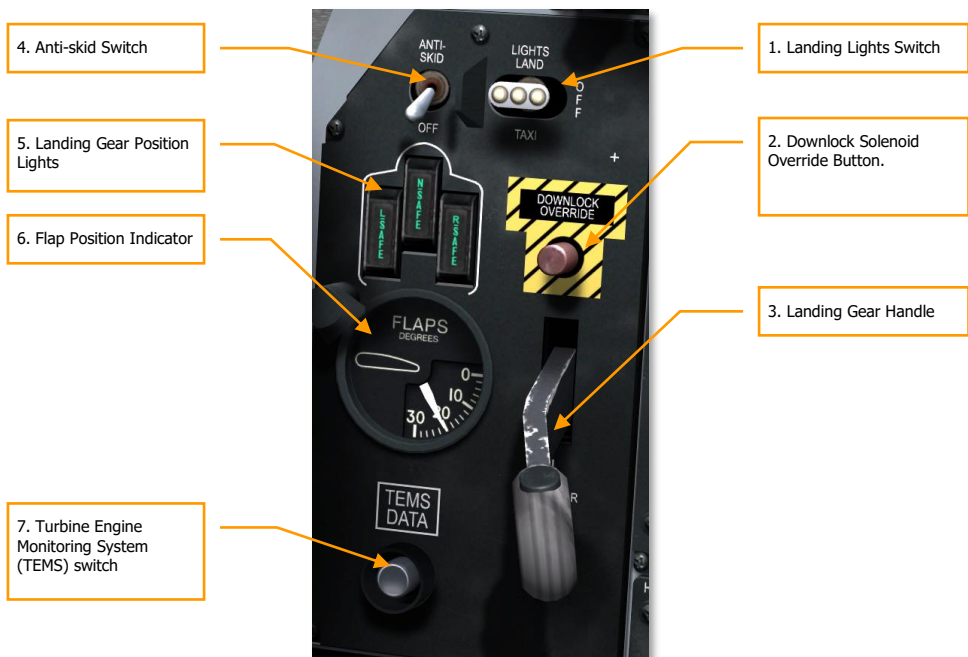

Figure 83. Landing Gear and Flap Control Panel

1. **Landing Lights Switch.** This three-position switch on the front console, above the landing gear handle, controls the fixed landing light on the nose wheel strut and the taxi light affixed to the lower portion of the nose wheel strut that turns in conjunction with the nose wheel. When the switch is in the TAXI (down) position, only the taxi light illuminates. When the LAND position is selected, both the landing and taxi lights illuminate. If in the center, OFF, position, both lights are turned off.
2. **Downlock Solenoid Override Button.** Depressing the button allows the landing gear handle to be moved to UP even if aircraft weight is on the main gear. However, the nose and main gear will not retract until weight has been removed from the main gear and both struts have extended.
3. **Landing Gear Handle.** Raise and lower the landing gear.
4. **Anti-skid Switch.** Prevents landing gear from locking when braking is enabled.
5. **Landing Gear Position Lights.** Indication of landing gear position. A green light indicates the landing gear is down and locked.
6. **Flap Position Indicator.** Located to the left of the landing gear handle, the Flap Position indicator provides you an indication of the current flap setting. The gauge displays an angle between 0 and 30 degrees, and the pointer will move to the current setting. Controlled by the left hydraulic system, the flaps consist of four trailing edge elements. The flaps have three positions that can be controlled from the flap control on the throttle. The positions are:
 - o **UP.** 0 degrees.
 - o **MVR,** Maneuver. 7 degrees (takeoff)
 - o **DN,** Down. 20 degrees

If the flaps lose hydraulic power, they will retain their current position unless the flap emergency retract switch is enabled. See Emergency Flight Control Panel chapter.

If airspeed exceeds 185 KIAS, the flaps cannot be extended. If the flaps are extended and the aircraft reaches 185 KIAS or greater, the flaps will automatically retract to the UP position. In such a situation, the flaps will extend to their previous position if the aircraft decelerates below 185 KIAS.

Powered by the right hydraulic system, the leading-edge slats are in the inboard portion of both wings. The slats deploy automatically according to angle of attack to provide best airflow to the engines.

7. **Turbine Engine Monitoring System (TEMS) switch.** This switch provides engine diagnostic data for maintenance support. No function in this simulation.

Armament HUD Control Panel (AHCP)

The AHCP is a physical panel on the front dash that is composed of seven large switches and three smaller switches. The AHCP replaces the Armament Control Panel (ACP) of the A-10A. Below, each switch is listed together with its possible settings:

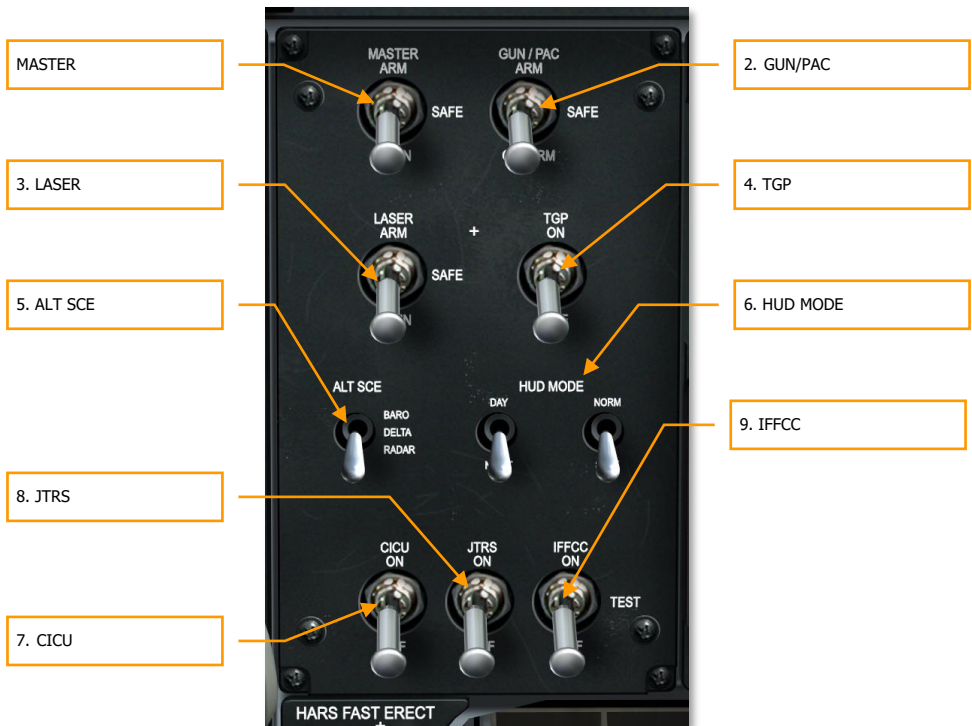

Figure 84. Armament HUD Control Panel

1. **MASTER.** The Master Arm switch enables the arming of weapon systems. The switch has three positions:
 - **ARM** position (Up). When set to ARM, the following functions are enabled:
 - Arming the gun. Must be set for the gun to be armed.

- Jettisoning weapons. Must be set for weapons to be selectively jettisoned. This does not apply to emergency jettison.
 - Trigger control. The trigger is inoperative unless set.
 - **SAFE** position (Middle). All ARM functions are disabled.
 - **TRAIN** position (Down). Places the weapon and control systems in training mode, indicated by blue symbology in the DSMS.
2. **GUN/PAC**. The GUN/PAC switch enables the gun with or without Precision Attitude Control (PAC) assist. PAC automatically adjusts aircraft pitch and yaw control inputs such that gun rounds fall in a tighter grouping around the aim point, rather than being impacted lengthwise along the aircraft's line of travel when firing. This switch has three positions:
- **ARM** position (Up). The gun is enabled. PAC will be active when the gun is fired.
 - **SAFE** position (Middle). Disables the gun from being fired.
 - **GUNARM** position (Down). The gun may be fired, but PAC assist will be disabled.
- Selecting the gun and placing the switch in either ARM or GUNARM will result in a "RDY" weapon status indication on the HUD.
3. **LASER**. The LASER switch enables the laser. This switch has three positions:
- **ARM** position (Up). Combat mode. The laser will fire at combat strength.
 - **SAFE** position (Middle). Disables the use of the laser in both combat and training settings. With the laser in SAFE mode, the "L" will not be displayed on the TGP page.
 - **TRAIN** position (Down). The laser will only fire at training level energy.
4. **TGP**. The Targeting Pod (TGP) switch enables targeting pod operation. This switch has two positions:
- **ON** position (Up). Enables the targeting pod to be used from the TGP MFC D page. After being selected, the TGP will begin its activation process. Placing this switch in the ON position provides power to the TGP and automatically begins cooling down the FLIR sensor.
 - **OFF** position (Down). Disables the targeting pod from being used on the TGP MFC D page. If the TGP page is accessed with the AHCP switch set to OFF, the TGP STANDBY page will be displayed with "TGP OFF" indicated.
5. **ALT SCE**. The ALT SCE switch selects the data source for altitude computations. This switch has three positions:

- **BARO** position (Up). Altitude data is derived from barometric.
 - **DELTA** position (Middle). Altitude will be derived from difference between barometric and radar.
 - **RADAR** position (Down). Altitude is derived from radar altimeter.
6. **HUD MODE.** The HUD MODE switches set the HUD DAY/NIGHT and NORM/STBY modes. Each of the two switches has two positions:
- **DAY/NIGHT** (Up/Down) toggle switch. Switches the HUD between day (green) and night (amber) modes.
 - **NORM/STBY** (Up/Down) toggle switch. Switches the HUD between normal and standby modes.
7. **CICU.** This switch applies power to the Central Interface Control Unit (CICU), which in turn provides data input to the MFCDs and associated subsystems. This switch has two positions:
- **ON** position (Up). This will result in data being supplied to the two MFCDs. Upon activation, the DTS load page is displayed on both MFCDs.
 - **OFF** position (Down). Deactivates (turns off) the two MFCDs and discontinues operation of any subsystems running from them.
8. **JTRS.** The Joint Tactical Radio System (JTRS) switch enables power to the Datalink system. This switch has two positions:
- **ON** position (Up). Switch may be set to the Up position to provide datalink power.
 - **OFF** position (Down). Switch may be set to Down position to discontinue power to the datalink system.
9. **IFFCC.** The Integrated Flight and Fire Control Computer (IFFCC) switch applies power to the IFFCC and HUD. This switch has three positions:
- **ON** position (Up): Activates the IFFCC system and displays (turns on) the HUD. (When the HUD is first displayed, it defaults to GUNS mode.)
 - **TEST** position (Middle): The HUD TEST setting displays the HUD settings display on the HUD.
 - **OFF** position (Down): Removes power from IFFCC and HUD (no display).

Heading Attitude Reference (HARS) Fast Erect Button



Figure 85. HARS Fast Erect Button

The HARS fast erect button is used to correct errors in the HARS attitude displays. When pressed, you will notice that the OFF flag on the ADI and the pitch angle from the HUD are removed. Pressing the switch re-cages the HARS gyro. As such, you will want to be flying straight and level when performing a HARS fast erect.

HARS is a backup gyro-system to EGI that provides heading and attitude aircraft state. Under normal conditions, you will have little use of HARS. HARS and EGI are mutually exclusive; meaning that you cannot select both simultaneously from the Navigation Mode Select Panel. Upon aircraft startup, HARS will be the active system until you select EGI by enabling it from the AAP.

When HARS is enabled, it will control the ADI and HSI.

Gun and Nose Wheel Steering (NWS) Lights



Figure 86. Gun Arm and Nose Wheel Steering Lights

Located at eye-level above the left MFC, this pair of lights operates independently. If the gun is armed and ready to fire, the GUN READY light will be displayed. If you have nose wheel steering enabled, then the STEERING ENGAGED light will be visible.

Center Front Dash

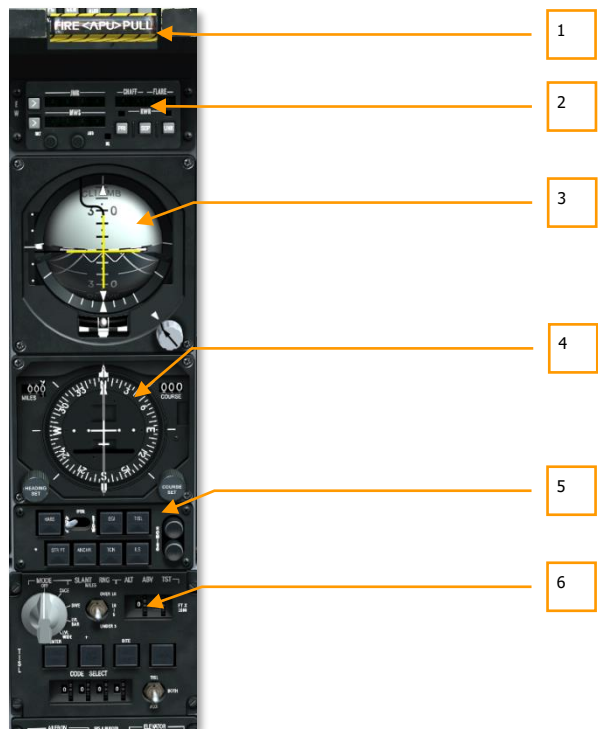

Figure 87. Center Front Dash

The center front panel is primarily dedicated to various flight control gauges and warning systems. While most of the primary flight information will be displayed on the heads-up display (HUD), these analog gauges can provide a valuable backup and provide additional information not present on the HUD.

1. APU "T Handle" fire extinguisher discharge select
2. Countermeasures Set Control (CMSC)
3. Attitude Director Indicator (ADI)
4. Horizontal Situation Indicator (HSI)
5. Navigation Mode Select Panel (NMSP)

6. Target Identification Set Laser (TISL) control panel

APU “T Handle” Fire Extinguisher Discharge Select



Figure 88. APU T-Handle

This “T” shaped handle is located below the HUD in the center of the dash. When a fire is detected in the Auxiliary Power Unit (APU), the handle will light indicate a fire there. By pulling a handle, you designate where fire extinguisher agent will be sent to after pressing the fire extinguisher discharge switch.

Countermeasures Set Control (CMSC)



Figure 89. Countermeasure Set Control

The CMSC panel displays the status and activity of the Electronic Countermeasure (ECM) system, the chaff and flare dispensers, and the Missile Warning System (MWS). This panel is discussed in detail in the Countermeasure Systems chapter.

Attitude Director Indicator (ADI)

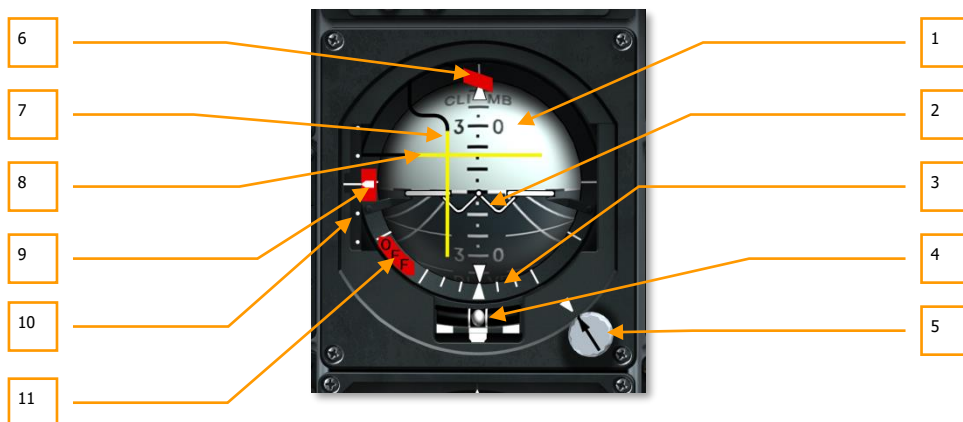

Figure 90. Attitude Director Indicator

Located centrally on the front dash, the ADI provides your primary instrument indication of aircraft pitch, roll and yaw in relation to an artificial horizon represented on a sphere. Elements of the ADI include:

1. **Attitude Sphere.** This sphere is divided into two hemispheres, dark etched with perspective lines representing the ground and light representing the sky. On the sphere are pitch angle markings and a dashed white line that represents the horizon.
2. **Miniature Aircraft.** Positioned in the center of the ADI is a marker shaped like a "W" with wings; this represents the current pitch and roll attitude of your aircraft in relation to the attitude sphere. If the marker is in the light hemisphere, the aircraft is pointed at the sky; if the marker is pointed into the dark hemisphere, the aircraft is heading towards the ground.
3. **Bank Scale and Bank Pointer.** Surrounding the lower half of the attitude sphere casing is a series of lines that indicate aircraft bank angle. Large tick marks are located at 90 degrees, 60 degrees and 30 degrees and smaller tick marks at 10 and 20 degrees. Attached to a point on the sphere that is perpendicular to the horizon is a small, white triangle. As the aircraft banks, this triangle moves in relation to the outside casing of the attitude sphere. The location of this mark along the bank scale indicates aircraft bank angle.

4. **Turn and Slip Indicator.** Located within a liquid-filled tube directly beneath the attitude sphere is a ball that can move laterally according to lateral accelerations. If the ball is centered in the tube, the plane is not slipping. Just below the slip indicator, the turn indicator displays the yaw rate.
5. **Pitch Trim Knob and Pitch Trim Index.** Rotating this knob allows you to manually calibrate the pitch angle of the aircraft symbol in relation to the horizon line. Next to the knob is a small triangle that represents a 0 pitch setting; this is called the Pitch Trim Index.
6. **Course Warning Flag.** Course Warning Flag. When selected ILS or TACAN mode on the Navigation Mode Select Panel and corresponding signal is not received, this flag at the top of the instrument will become visible. If you wish, you can stow the Flag by setting the PTS switch on the Navigation Mode Select Panel to STOW position.
7. **Bank Steering Bar.** This vertical bar indicates deviation from the desired HSI bearing. This bar can also be used to determine if the aircraft is flying towards a tracked TISL target or a selected VHF/FM ADF transmitter. If the bar is centered, you are flying to the desired destination; if it is off to either side, you will need to bank the aircraft towards the direction the bar is positioned from center.
8. **Pitch Steering Bar.** This horizontal bar is used to indicate if the aircraft has intercepted the ILS glide slope; the aircraft has reached the programmed ADF FM station; or tracking a tracked TISL target. Regarding FM station finding, the bar indicates signal strength - low or high on the ADI.
9. **Glide Slope Warning Flag.** If no ILS glide slope signal is detected, this flag at the left of the instrument will become visible.
10. **Glide Slope Deviation Scale and Glide Slope Indicator.** Arrayed vertically along the left side of the ADI is a line with two equally spaced dots above it and below it. This is the Glide Slope Deviation Scale and is used when performing an Instrument Landing System (ILS) landing. To the right of the scale is a white chevron that moves up and down the scale according to your position on the glide slope. If you are too high, the chevron will be below the center line; if you are too low, the chevron will be above the center line.
11. **Attitude Warning Flag (OFF).** If the ADI loses electrical power, the OFF warning flag will be displayed. Additionally, this flag will also be displayed while you depress the HARS fast erect button when HARS is selected on the NMSP.

Horizontal Situation Indicator (HSI)

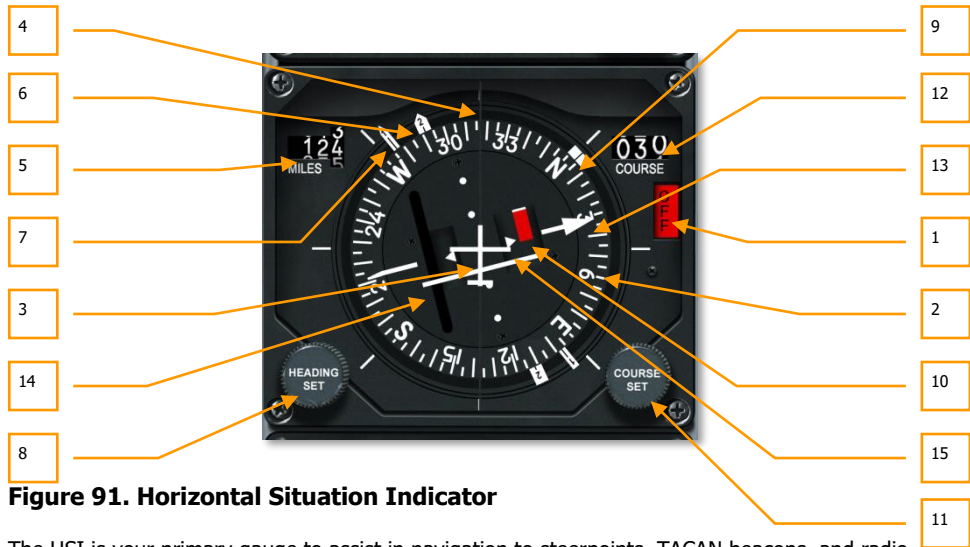

Figure 91. Horizontal Situation Indicator

The HSI is your primary gauge to assist in navigation to steerpoints, TACAN beacons, and radio beacons. While you will likely be using HUD symbology for most of your navigation purposes, a firm understanding of the HSI is necessary for access to additional navigation data that is not present on the HUD or CDU displays, and in case of battle damage. Elements of the HSI include:

1. **Power OFF Flag.** If the HSI gauge has no power, this red OFF warning flag will appear in the right side of the gauge.
2. **Compass Card.** Arrayed around the periphery of the HSI, this is a compass that rotates such that the top of the compass indicates the aircraft's magnetic heading.
3. **Aircraft Symbol.** In the center of the gauge is the aircraft symbol that always remains static. All HSI displays are in reference to this symbol.
4. **Lubber Line.** This is a fixed line that runs from the aircraft symbol to the top of the gauge. This line represents current aircraft heading in relation to the compass card.
5. **Range Indicator.** Indicating range in nautical miles, this three-place drum indicator provides slant distance from your aircraft to the selected steerpoint or TACAN station. When there is no power supplied to this gauge, a striped white/orange warning flag covers the digits.

6. **Bearing Pointer 2.** This arrow-shaped indicator moves around the outside of the compass card and points to the current steerpoint. Located 180° from the Bearing Pointer 2 head is the tail that represents the reciprocal bearing.
7. **Bearing Pointer 1.** The arrow indicator, which is longer and skinnier than the Bearing Pointer 2 indicator, points to the magnetic bearing of the selected TACAN station when TACAN mode is selected. When in ADF mode, this indicator points to magnetic bearing of the selected UHF station. If both TACAN and ADF are selected, the ADF takes priority. If neither TACAN nor ADF modes are selected, the indicator aligns with Bearing Pointer 1. Located 180° from the Bearing Pointer 1 head is the tail that represents the reciprocal bearing.
8. **Heading Set Knob.** Located in the lower left portion of the gauge, when rotated, this knob allows you to set the position of the Heading Marker on the compass card.
9. **Heading Marker.** Shown as two thick lines on the outside of the compass card, this marker can be moved around the compass card using the Heading Set Knob. After being set, this marker rotates with the Compass Card to provide a heading to the selected magnetic bearing.
10. **Bearing Validity Flag.** If the aircraft is significantly off course, this flag will become visible.
11. **Course Set Knob.** Positioned in the lower right corner of the gauge, this knob, when rotated, allows you to set the course numeric in the Course Selector Window and move the course arrows around the compass card.
12. **Course Selector Window.** This window displays the course set using the Course Set Knob numerically in degrees.
13. **Course Arrow.** Set by the Course Set Knob, these two lines represent the set course and reciprocal course on the compass card.
14. **Course Deviation Indicator (CDI).** This line that runs through the center area of the gauge provides an indication of how accurately you are flying on the set course line. When the line runs through the aircraft symbol in the center of the gauge, you are on course. If it is to either side, you need to correct your heading to place the aircraft back on the course line.
15. **To-From Indicator.** These two triangles along the intended course line indicate the course the aircraft will fly to or away from the selected TACAN station or steerpoint.

Navigation Mode Select Panel

The A-10C has various means to navigate to mission locations that include ADF homing UHF/FM, TACAN (Tactical Air Navigation) stations, Inertial Navigation System (INS) steerpoints and Instrumented Landing System (ILS). To select between these different navigation inputs, you will use the Navigation Mode Select panel. These data inputs will in turn drive data being displayed on the ADI, HSI, and HUD.



Figure 92. Navigation Mode Select Panel

The Navigation Mode Select panel is located on the central dash, directly below the HSI gauge. The panel consists of seven buttons, a two-position switch, and two indicator lights. When one of the seven buttons is active, a green triangle will appear in it. The seven buttons include:

1. **HARS.** Sets HARS as the input for the HSI, ADI, and HUD. HARS is on by default when performing a cold start. Remember to switch to EGI!
16. **EGI.** Navigation data is driven by the CDU. To display the Total Velocity Vector and other HUD symbology, you must enable EGI. See CDU chapter.
Note: HARS and EGI are mutually exclusive.
17. **TISL.** Elevation and azimuth data from the laser spot tracker determines the ADI pitch and bank steering bars.
18. **STR PT.** When enabled, the CDI on the HSI will be set to the steerpoint.
19. **ANCHR.** Navigation data on the HSI, ADI and HUD and according to the anchor point set in the CDU. See CDU chapter.
20. **TCN.** Navigation data on the HSI, ADI and HUD and according to the selected TACAN station.
21. **ILS.** Glide slope information for instrumented landing system is displayed on the ADI and HSI receives localizer information. See ILS chapter.
22. **UHF Homing Light.** When the UHF control panel is set to ADF mode, the UHF light will turn amber.
23. **VHF Homing Light.** When the VHF/FM control panel is set to homing mode, the FM light will turn amber.

24. **Pitch and Roll Bar Switch.** The switch labeled PTR enables you to display or stow the pitch and roll steering bars on the ADI and the course warning flag. Setting this switch to ABLE enables them to be shown and setting the switch to STOW disables them unless TISL or FM homing are active.

Right Dash



Figure 93. Right Front Dash

The right front dash is primarily dedicated to various engine monitoring, fuel panel and the right MFCD. While most of the primary flight information will be displayed on the heads-up display (HUD), the analog gauges can provide a valuable backup and provide additional information not present on the HUD.

1. Fire extinguisher discharge switch
2. Right Multifunction Color Display (MFCD)
3. Fuel quantity and hydraulic indicator panel
4. Right engine "T Handle" fire extinguisher discharge select
5. Marker and Canopy lights

6. Vertical Velocity Indicator (VVI)
7. Altimeter
8. Engine monitoring instruments

Fire Extinguisher Discharge



Figure 94. Fire Extinguisher Discharge

Once one of the three “T” handles has been pulled, you may press the FIRE EXTING DISCH switch on the right side of the dash left or right. Pressing left or right activates the left or right pressurized extinguisher bottles to the designated area. As such, you have only two bottles of extinguisher to use.

Right Multifunction Color Display (MFCD)

The right MFCD performs exactly as the left MFCD. Please consult the left MFCD sections for details.



Figure 95. Right Multifunction Color Display

Fuel Quantity and Hydraulic Indicator Panel

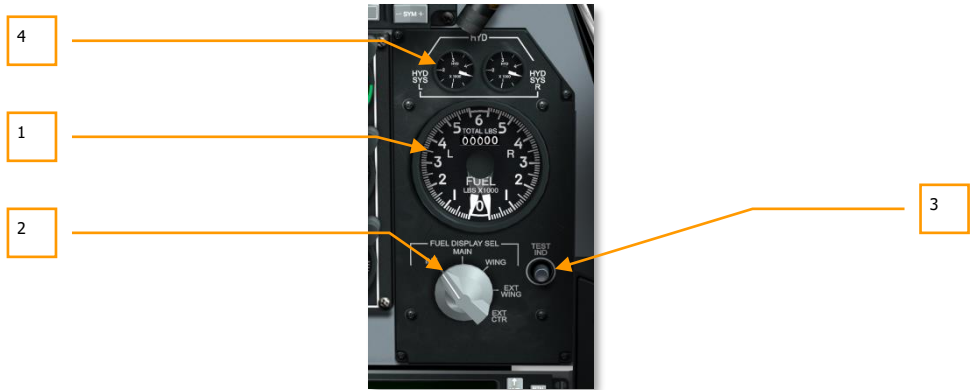

Figure 96. Fuel Quantity and Hydraulic Indicator Panel

The fuel storage system for the A-10C consists of left and right internal wing tanks and right and left fuselage tanks. The right-side fuel tanks feed the right engine and the left side tanks feed the left engine and APU. Additionally, the aircraft can be loaded with up to three 600-gallon external fuel tanks (TK600 external store). To provide fuel pressure, each tank has a co-located boost pump.

Due to differing boost pump pressures, the wing tanks will automatically empty before the fuselage tanks.

To provide redundancy, the fuel system operates under two independent systems. However, cross-feeding between the two fuel systems can be enabled from the Fuel System Panel.

Internally, the A-10C can carry 1,630 gallons of fuel and an additional 1,800 gallons externally.

1. **Fuel Quantity Indicator and Selector Panel.** This panel located on the right side of the front dash provides you information on fuel remaining and left and right hydraulic system pressure. Using the rotary dial, you may view remaining fuel according to types of fuel tanks. Components of the gauge include:
2. **Fuel Quantity Gauge.** The large, circular gauge displays fuel remaining according to the fuel display selector setting. The gauge consists of two analog pointers (left and right) that indicate fuel loading in each fuel systems (left and right) in thousands of pounds. In the top center of the gauge is a digital indication of total fuel remaining in pounds.

3. **Fuel Display Selector.** Below the fuel quantity gauge is the Fuel Display Selector Dial. This is a five-position dial that enables you to determine which set of fuel tanks are determining the fuel gauge readings (not including the digital reading). The settings include:
 4. **INT.** Left and right pointers indicate total internal fuel for respective system
 5. **MAIN.** Left and right pointers indicate fuel in their respective main tank
 6. **WING.** Left and right pointers indicate fuel in their respective wing tank
 7. **EXT WING.** Left and right external fuel tanks
 8. **EXT CTR.** Left pointer indicates centerline external fuel tanks and right pointer will indicate 0
 9. **Test Button.** While this button is depressed, it will test the fuel quantity gauge. The two pointers will point to 3 and the digital readout will indicate 6,000 until the button is released.
10. **Hydraulic System Pressure Gauges.** Located at the top of the Fuel Quantity Indicator and Selector Panel, these two gauges indicate the current hydraulic pressure for the two, independent hydraulic systems.

As with the fuel system, the A-10C has two hydraulic systems, each with their own systems they power. The left hydraulic system powers left rudder, left elevator, left and right ailerons, flaps, landing gear, wheel brakes, and nose wheel steering. The right hydraulic system powers right rudder, right elevator, left and right ailerons, speed brakes, slats, auxiliary landing gear extend, emergency wheel brake, and slipway door.

Located on the Fuel Quantity Indicator and Selector Panel, gauges for the left and right hydraulic pressure are located. These are labeled HYD SYS L for left hydraulic system and HYD SYS R for the right hydraulic system. Indications are a measure of psi and a normal reading is above 1000 psi.

- Maximum pressure is above 3,350 psi
- Normal pressure is between 2,800 and 3,350 psi

RIGHT Engine "T Handle" Fire Extinguisher Discharge Select



Figure 97. Right T-Handle

This "T" shaped handles are located below the HUD on the right side of the front dash. When a fire is detected in the right engine, the handle will light indicating a fire there. By pulling a handle, you

designate where fire extinguisher agent will be sent to after pressing the fire extinguisher discharge switch.

Marker and Canopy Lights



Figure 98. Marker and Canopy Lights

Located on the right dash, this pair of lights operates independently. If you are in ILS mode and over-fly a marker beacon, the MARKER BEACON light will be visible. If the aircraft canopy is open, the CANOPY UNLOCKED light will appear.

Vertical Velocity Indicator (VVI)



Figure 99. Vertical Velocity Indicator

The VVI displays rate of climb or descent in increments of feet per minute. The scale is in increments of 100 feet.

Altimeter



Figure 100. Altimeter

This altimeter gauge measures barometric altitude in relation to altitude above sea level. Along the outside ring of the gauge are markers for 200-foot increments (1 to 0). In the center of the gauge is a pointer that indicates the current altitude along the 100-foot scale. In the center of the gauge are indicators for the current 1,000-foot and 100-foot readings; the indication after these is always 00. Beneath and to the right of these indicators is a field that can be used to manually enter a barometric altitude (such as your takeoff / landing airfield).

1. **Pressure Set Knob.** Rotate this knob clockwise or counterclockwise to manually set a barometric altitude.
2. **Elect/PNEU Switch.** Located outside the lower right corner of the gauge is a two-position switch that allows you to select normal, electric mode (ELECT) or pneumatic mode (PNEU) for altimeter operation. In case of a CADC failure, you should set the instrument to PNEU.

Engine Monitoring Instruments (EMI)



Figure 101. Engine Monitoring Instruments

Located on the lower right side of the front dash is an array of gauges that indicate engine and APU operational feedback. These include:

Engine Oil Pressure Indicators. Oil pressure indications for both engines.

- Maximum oil pressure is 95 psi
- Normal idle pressure range is 55 to 85 psi
- Acceptable pressure when core rpm is 85% is 40 to 55 psi
- Minimum pressure is 40 psi

Engine Core Speed Indicators. Engine core speed for each engine as a percent of compressor rpm.

- Engine operation should not exceed 102%.
- Engine operation between 100 and 102% should not exceed 3 seconds.
- Normal operating range should be between 56 and 98%.

Engine Fan Speed Indicators. Indication of rpm fan speed of each engine.

- Normal operation is approximately 82% at takeoff.

Engine Interstage Turbine Temperature (ITT) Indicators. Indication of temperature for each engine between high and low turbine sections.

- A stabilized temperature above 865-C indicates an engine malfunction.
- A short period at 900-C is possible during engine start.
- Normal operating range is between 275 and 865-C.

Engine Fuel Flow Indicators. Indication of fuel flow to the engines.

- Normal fuel flow is between 1500 and 4100 pounds per hour (PPH)

APU Exhaust Gas Temperature (EGT) Indication. Operating temperature of the APU.

- Normal operation between 200 and 715-C
- Maximum at engine start for two seconds is 760-C

APU RPM. Operating RPM of the APU.

- Normal operation of 100%
- Maximum operation at 110%
- Engine start minimum of 60%

Heads Up Display Area Above Dash

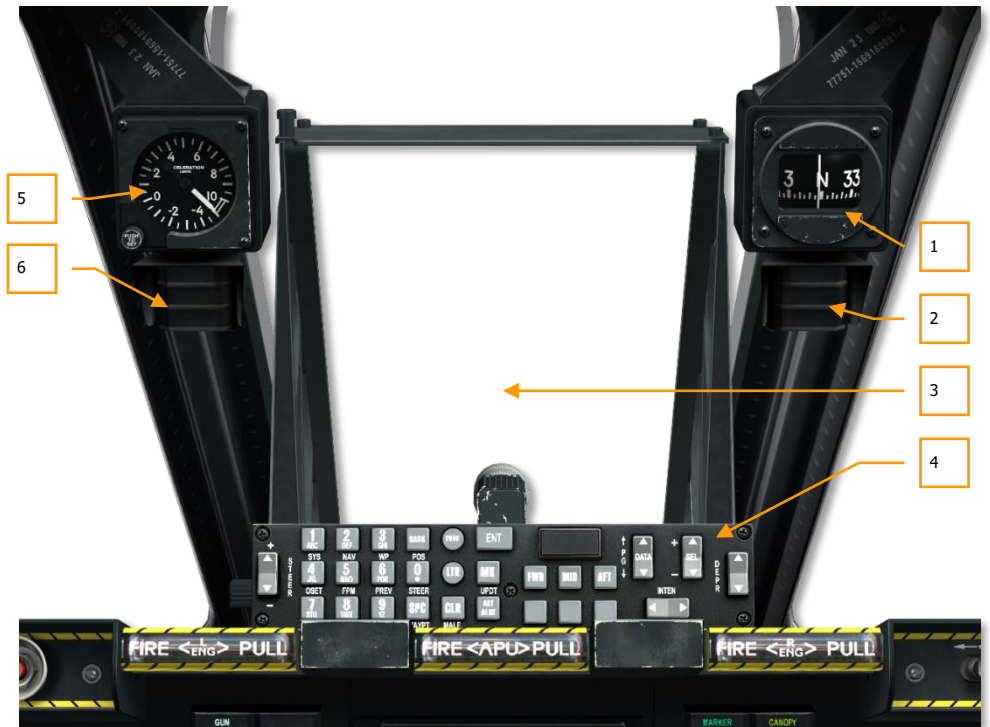

Figure 102. HUD Area

The area over the front dash primarily consists of the Heads-Up Display (HUD) and the Up-Front Controller (UFC) beneath the HUD. This area also has a set of gauges and lights.

1. Standby compass
2. Aerial refueling status indicator
3. Heads Up Display (HUD)
4. Up Front Controller (UFC)
5. Accelerometer (G-meter)
6. Angle of attack indexer

Standby Compass



Figure 103. Standby Compass

Hanging from the right canopy bow, this is a basic, liquid-filled, magnetic compass. Because it is a pendulum-type bearing, it is not stabilized and will tilt. The compass is most accurate in level flight and will lose accuracy as bank angle increases due to the mechanical limit.

Air Refuel Status Lights

These three lights provide you an indication of the aerial refueling status. After the aerial refueling slipway door has opened, the READY light will come on. Once refueling nozzle has locked into the refueling receptacle, the READY light will turn off and the LATCHED light will come on. After nozzle is removed, the DISCONNECT light will come on. After the slipway door has been closed, the light will go off.

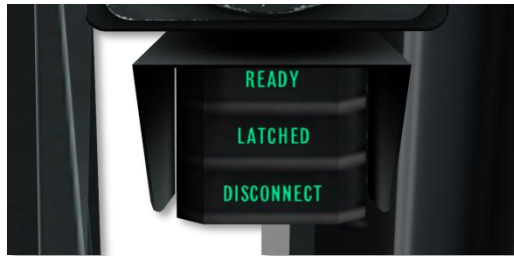

Figure 104. Air Refuel Status Lights

Accelerometer (G-meter)



Figure 105. Accelerometer

Located on the left canopy bow, this gauge indicates current G-loading on the aircraft. The pointer will indicate current positive or negative value.

Angle of Attack Indexer



Figure 106. AoA Index Lights

The AoA Indexer is located on the left/front canopy rail beneath the accelerometer gauge and provides indication of proper landing angle of attack.

The indexer presents the information by displaying illuminated green and yellow symbols; low-speed symbol V, on-speed symbol ○, and high-speed symbol Λ. Slightly low/high speed is indicated by the on-speed and low/high speed symbols coming on simultaneously. The AOA indexer lights operate only when the nose gear is down.

Left Console

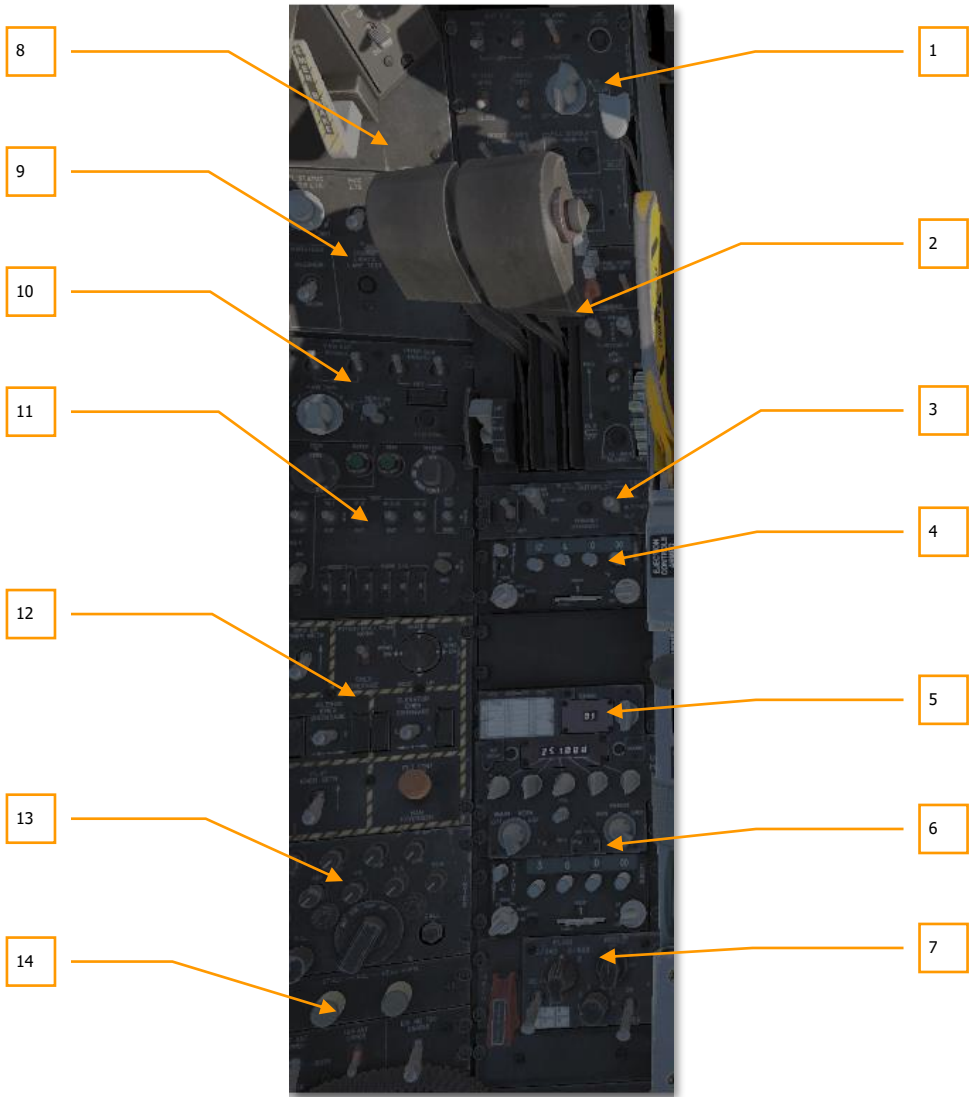

Figure 107. Left Console

The left console has a variety of panels that include the throttles, radios, fuel system, and flight controls to name a few.

1. Fuel system control panel
2. Throttles panel
3. Low Altitude Safety and Targeting Enhancement (LASTE) control panel
4. AN/ARC-186(V) radio control panel
5. AN/ARC-164 UHF radio control panel
6. AN/ARC-186(V) VHF radio 2 control panel
7. KY-58 Secure voice control panel
8. Emergency brake system
9. Auxiliary lighting control panel
10. Stability Augmentation System (SAS) panel
11. IFF/SIF control panel
12. Emergency flight control panel
13. Intercom control panel
14. Stall warning control panel

Fuel System Control Panel

Used to control fuel tank feeding and boost pump control, the Fuel System Control Panel is located on the forward section of the left console. Controls available on this panel include:



Figure 108. Fuel System Control Panel

1. **Main Boost Pump Switches.** To provide needed fuel pressure from the main left and right fuel tanks, boost pumps are enabled with the left (L) and right (R) BOOST PUMP switches. The pumps can be enabled and disabled individually for the left and right main tanks.
2. **Wing Boost Pump Switches.** To provide needed fuel pressure from the left- and right-wing fuel tanks, boost pumps are enabled with the left (L) and right (R) BOOST PUMP switches. The pumps can be enabled and disabled individually for the left- and right-wing tanks.

3. **Wing and Fuselage External Tank Switches.** In the top left of the panel are switches to enable or disable the transfer of fuel from external fuel tanks. These paired switches labeled EXT TKS both have OFF down positions. The left switch up position is labeled WING and enables the transfer of fuel from any loaded external fuel tanks attached to the wings. The right switch up position is labeled FUS and enables the transfer of fuel from a center fuselage loaded external fuel tank.
4. **Crossfeed Switch.** Although the A-10C fuel system is designed with two parallel fuel systems, setting the Crossfeed switch to CROSSFEED will link the two fuel systems and allow the boost pumps to feed both engines. If the Crossfeed switch is set to OFF, both fuel systems are isolated. You would most often use Crossfeed when one of the boost pumps fails.
5. **Tank Gate Switch.** Linking the left and right main fuel tanks is a transfer valve that may be opened by setting the TK GATE switch to the OPEN position. Setting this switch to CLOSE will isolate the two tanks from each other. Generally, you will want to keep this switch disabled as being enabled can lead to fuel center of gravity problems.
6. **Air Refuel process.** Using the flying-boom aerial fueling process, the A-10C may refuel in flight. The aerial refueling port is located directly forward of the cockpit and has a retractable slipway door that opens to the receptacle. Once the refueling probe has latched into the receptacle, fuel is transferred automatically to the main and wing fuel tanks. However, you may prevent the filling of selected fuel tanks using the Fill Disable buttons. You may want to do so for battle damage reasons.

For a more detailed discussion on aerial refueling, consult the Flight School chapter.

7. **Air Refuel Control Lever.** The gray lever labeled RCVR allows you to open and close the refueling port slipway door. Moving the lever down to the OPEN position opens the door and moving forward to the CLOSE position closes the door.

When the door is opened, the READY status light appears on the canopy rail indicator. When the refueling probe is latched in the receptacle, the READY light is replaced with a LATCHED light. After the probe has been disconnected, a DISCONNECT light appears but will be removed once the lever is moved to the CLOSE position.

8. **Fill Main and Wing Tank Disable Switches.** To disable the filling of the four internal tanks (due to battle damage for instance), you can elect to disable filling of a selected tank. Two sets of buttons are present, left and right main tanks and left and right wing tanks. These switches act like circuit breakers in that when you select them they are pulled out and the selected tank will be disabled for refill.
9. **Exterior Lighting Dial.** This dial allows adjustment of lights around aerial refueling receptacle and floodlight over the engines. To assist in aerial refueling, a flood light is located on the spine

of the fuselage that illuminates the two engine nacelles. Additionally, two illumination lamps are located on either side of the aerial refueling slipway. Located on the Fuel System Control panel is the RCVR LT dial that allows you to set the brightness of these lights. The dial can be set between OFF (no lighting) to BRT (full brightness).

10. **Line Check Button.** No function

11. **Signal Amplifier Switch.** No function

Note: For negative G flight, the A-10C has collector tanks that will supply the engines with sufficient fuel for 10 seconds of operation at MAX power. If you fly at negative G for more than 10 seconds, you risk the engines shutting down due to lack of fuel supply.

Throttles Panel

The A-10C is powered by two General Electric TF34-GE-100A engines, each with a maximum thrust of 8,900 pounds. Each engine is composed of a 14-stage axial flow compressor with a single bypass fan. The bypass air provides 85% of the total engine thrust. Given the role in fan speed in producing thrust, the fan speed indication is your best indication of total engine thrust.

When the engine is under power, a gear box from the engine provides power to run electrical generators, oil pumps, fuel control and fuel pump, hydraulic pump, and bleed air.

Engine power is controlled by the throttle lever on the left side of the cockpit. Moving the throttle forward increases power and pulling the throttle towards you decreases power. For the engines to generate thrust from idle to full power takes approximately 10 seconds. So, as you can see, power generation is not instantaneous.

To start the engines without need of an external power source, the A-10C is equipped with an Auxiliary Power Unit (APU). In this simulation, this will be the means you will use to start both of your engines.



Figure 109. Throttles Panel

The APU allows the aircraft to start engines using compressed air for turning the turbines; temporarily provides DC and AC electrical power; and temporarily powers the hydraulic systems. The APU draws fuel and is in the rear of the aircraft between the two engines.

1. **APU Switch.** The APU switch is located on the throttle panel and is used to activate and deactivate the APU with a two-position switch. Setting this switch to the START position will do the following if the Battery Power Switch has been set to PWR:
 1. Enables the fuel pump that feeds the APU
 2. Opens the APU fuel valve
 3. Enables the APU starter
 4. Activates the gauges for APU EGT and APU tachometer

5. Once the APU has been successfully started, you will need to enable the APU Generator Power switch to allow the APU to provide DC and AC electrical power.
2. **Throttles.** The A-10C throttle is a split throttle, meaning that it consists of two levers, each controlling the thrust of a single engine. These levers are generally moved in unison, but they can be moved independently for cases such as engine start, engine damage or adjusting yaw. The throttle has three positions which are marked on the right side of the levers: OFF, IDLE and MAX.
 - 2.1. **OFF.** When in the OFF position, the fuel pumps are shut off and no fuel is provided to the engines. Setting the throttles to OFF will shut off the engines or make it impossible to start them when in this position.
 - 2.2. **IDLE.** When moved forward to the IDLE position, several actions are enabled that automatically start the engine. These include the fuel pumps being enabled; Air Turbine Start (ATS) valves open; engine bleed air valves are opened, and ignition is supplied to the engines.

Note: For engine start, electrical and APU systems will first need to be enabled.
 - 2.3. **MAX.** This stop is at the forward limit of the throttles and represents maximum thrust (generally 82% fan speed at takeoff).

Moving the throttle between IDLE and MAX controls the amount of fuel supplied to the engines and thus controls the thrust commanded to the engines. However, commanded thrust can be overridden in case of engine over-temperature.

To the right of the throttle on the throttle panel are several switches that provide engine and APU control.

3. **Engine Fuel Flow Switches.** Positioned at the top of the throttle panel, these two switches have two possible positions: NORM and OVERRIDE. The switch underneath the "L" controls fuel flow to the left engine and the switch underneath the "R" controls fuel flow to the right engine. When set to NORM, fuel flow is controlled by throttle position and maximum power trim. When in the OVERRIDE position, fuel is controlled by throttle position only and exceeding ITT limits is possible.

When set to Override, these switches disable to ITT amplifier and give you direct control of fuel flow, thus allowing you to obtain normal engine operation in situations where the ITT amplifier has failed. At most this will allow you to exceed the ITT limits, and possibly push the core RPM a few percent higher.

This function is not designed to give you a power boost to get you out of trouble or go a bit faster; it's there to allow you to make it home in case of engine damage. In most cases switching to override will result in no change to engine performance, only in cases where the ITT amplifiers are limiting core rpm/and exhaust gas temp will overriding them cause the engine RPM/ITT to increase.

4. **Engine Operate Switches.** These two three-place switches are used to set the three operating modes of the two engines. The switch underneath the "L" label is for the left engine and the switch underneath the "R" label is for the right engine. The default position is the center position marked NORM. If either switch is set to NORM and the corresponding throttle is moved to IDLE, the engine ignition will start for that engine.

If one of the switches is held in the IGN position, a manual engine ignition for that engine will be initiated regardless of the engines current throttle setting or RPM. This would most often be used for an [in-flight windmill engine restart](#) that relies on the power of one engine to crank the un-powered one.

Moving one of the switches to the MOTOR position when a throttle is set to OFF will attempt to purge the combustion chamber of the affected engine of fuel. This will be required after a failed engine start and the need to purge fuel before a restart to avoid a hot start. MOTOR is also used for an engine restart with the APU operating.

For more details on use of the MOTOR and IGN Engine Operate Switches, please see the [Emergency Procedures](#) chapter.

5. **Landing Gear Horn Silence Button.** This button below the APU switch will silence the landing gear horn.

LASTE Control Panel

Introduced into later versions of the A-10A, the Low Altitude Safety and Targeting Enhancement (LASTE) system provides several advancements to the A-10A and later A-10C. Chief among them is the autopilot system, CCIP and CCRP bombing modes, air-to-air HUD mode, and the EAC.

Ground Collision Avoidance System (GCAS)

GCAS provides you warning of a potential ground impact; however, it will not prevent the impact. GCAS uses a combination of inputs from the radar altimeter, INS and LASTE computer to judge such an event. A GCAS warning is indicated by a large, flashing break-X on the HUD and a "PULL UP, PULL UP" audio message.

GCAS can provide you with an "ALTITUDE, ALTITUDE" audio alert messages when the aircraft is below a preset mean sea level (MSL) altitude and above ground level (AGL) altitude. These altitudes are set on the Up-Front Controller (UFC).

If the speed brakes are open and the landing gear handle is up with only one throttle at maximum power or both throttles at maximum power but less than 145 KIAS, then the "SPEEDBRAKES, SPEEDBRAKES" audio message will be heard. The same audio message will be heard if the speed brakes are open, the landing gear handle is down, at least one throttle is at maximum power, and air speed is less than 145 KIAS.

Continuously Computed Impact Point (CCIP) bomb release mode

When an unguided weapon is selected for CCIP delivery, the pipper and reticle on the HUD continuously display the impact point of the weapon when in valid solution. See HUD chapter for more detail.

Continuously Computed Release Point (CCRP) bomb release mode

The CCRP option allows you to deliver unguided and guided weapons on the SPI ground location that is not visible (below) the HUD field of view. See HUD chapter for more detail.

Enhanced Attitude Control (EAC)

The EAC provides three autopilot modes to the A-10C: Path, Altitude/Heading and Altitude/Bank. Additionally, it provides the Precision Attitude Control (PAC) system for a more accurate gun strafe. EAC relies on LASTE, INS and SAS to work properly.

NOTE: EAC will disarm (switch moved automatically to off) when invalid data is received from the LASTE sensors (CADC, EGI, and SAS), or, when any of the SAS Engage switches on the SAS Control Panel are disengaged, or, when EGI is deselected either automatically (by an EGI failure) or manually via the switch on the NMSP. Any disarming of EAC will cause the EAC light on the caution light panel and the MASTER CAUTION light to illuminate. If autopilot mode was engaged, the audio warning "WARNING, AUTOPILOT", occurs over the intercom. Engagement of the EAC autopilot or PAC modes is possible only if the EAC switch is set to ARM, SAS is engaged, IFFCC switch in position other than OFF, EGI is selected, BLENDED or INS-only NAV solution is selected after full EGI INS alignment, and air refueling door lever is in the closed position.

Air-to-Air HUD mode

New elements on the Air-to-Air HUD include a funnel gunsight, multiple reference gunsights (MRGS), and an air mass impact line (AMIL). See HUD chapter for more details.

The LASTE Control panel is located directly behind the throttle panel and allows control of the EAC, radar altimeter, and LAAP modes.



Figure 110. LASTE Control Panel

1. **EAC Switch.** The EAC switch has two positions, OFF (down) and ARM (up). When in the ARM position, EAC is provided to LASTE. If in the OFF position, the EAC functions are disabled and the EAC caution light appears.
2. **Radar Altimeter.** The two-position switch labeled RDR ALTM allows you to enable or disable the radar altimeter. If the switch is in the NRM (normal) position, the radar altimeter is functioning and will provide data for GCAS functions. If, however, the switch is in the DIS (disable) position, the radar altimeter is disabled as well as GCAS functions.
3. **Autopilot Select Switch.** Located along the right side of the panel is a three-position switch that allows you to select the active autopilot mode. These autopilot modes form the Low Altitude Autopilot (LAAP) system. The three selections are:
 - 3.1. **PATH** (top position). This mode will attempt to keep the aircraft on its current flight path, represented by the total velocity vector symbol on the HUD. This mode will not engage with a bank angle greater than 10°.
 - 3.2. **ALT/HDG** (middle position). This mode will attempt to maintain the barometric altitude and heading of the aircraft when the mode was activated. This mode will not engage with a bank angle greater than 10°.
 - 3.3. **ALT** (down position). When this mode is engaged, the autopilot will attempt to maintain current bank angle and barometric altitude.

Note: The A-10C does not include a route autopilot system that automatically flies the aircraft to a steerpoint or along a loaded flight plan.

Once an autopilot mode is selected, you must press the Autopilot Engage button to activate the mode. You may also press the autopilot engage/disengage left throttle button.

If a control input is commanded while in autopilot, the active autopilot mode will automatically disengage and a "WARNING, AUTOPILOT" message will be heard. You can also disengage autopilot by pressing the Autopilot Engage/Disengage button or left throttle button.

4. **Autopilot Engage/Disengage Button.** To the left of the LAAP mode switch is the Autopilot Engage/Disengage button. This button will enable, if conditions are suitable, the selected autopilot mode if no mode is active. If, however, an autopilot mode is active, pressing this button will disable autopilot.

AN/ARC-186(V) Radio Control Panel

This radio will be replaced by the AN/ARC-210 in a later version. The ARC-210 will be documented here in the future.

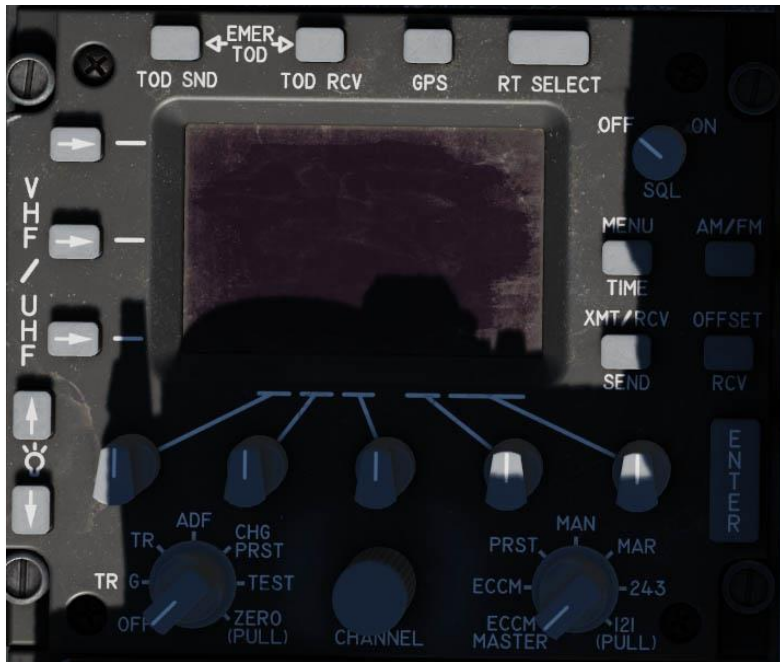

Figure 111. ARC-210 Radio Head

AN/ARC-164 UHF Radio Control Panel

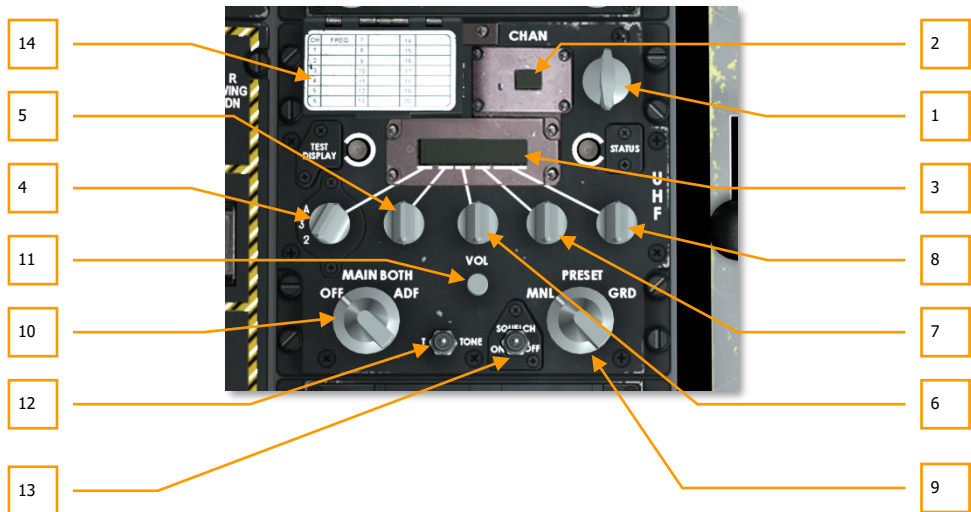

Figure 112. ARC-164 Radio Head

The AN/ARC 164 UHF radio, located on the left console aft of the throttle panel, provides you the ability to transmit and receive communication on designated UHF frequencies.

The UHF radio has 20 preset channels (PRESET) and the ability to manually enter a channel frequency (MNL). The frequency range runs from 225.000 to 399.975 MHz.

During most missions, you will communicate with your flight using this radio.

If during a mission the amount of radio traffic from this radio becomes too much, you can always turn down its volume using the Volume Knob or switch the frequency.

When flying a mission, various assets (wingman, support flights, controllers, etc.) will be assigned unique frequencies. You will need to be aware of these frequencies and set your UHF radio accordingly to communicate with those assets.

1. **Preset Channel Selector.** In top right corner of the panel is the Preset Channel Selector dial. Rotating this dial clockwise or counterclockwise will cycle through the 20 preset UHF channels. The preset channel number is displayed in the Preset Channel Indicator window and the frequency associated with the selected channel is displayed in the Frequency Status Indicator window. This channel is also repeated on the front dash in the UHF Frequency Repeater.
2. **Preset Channel Indicator Window.** The preset UHF channel selected via the Preset Channel Selector dial is displayed in this window (1 – 20).
3. **Frequency Status Indicator Window.** After a frequency has been selected as a preset or entered manually, the six-digit frequency is displayed in this window.
4. **100 MHz Selector.** Rotating this dial sets the 100 MHz digit of the frequency. This dial has three positions: 2, 3, or A.
5. **10 MHz Selector.** Rotating this dial sets the 10 MHz digit of the frequency. This dial can be rotated to select between 0 and 9.
6. **1 MHz Selector.** Rotating this dial sets the 1 MHz digit of the frequency. This dial can be rotated to select between 0 and 9.
7. **.1 MHz Selector.** Rotating this dial sets the tenths MHz digit of the frequency. This dial can be rotated to select between 0 and 9.
8. **0.025 MHz Selector.** Rotating this dial sets the thousandths MHz digit of the frequency. This dial can be rotated to select between 0 and 75 in steps of 25.
9. **Frequency Mode Dial.** This three-position dial located in the lower right portion of the panel allows you to determine how a frequency is set in the Frequency Status Indicator window.
 - 9.1. **MNL.** Manual mode allows you to use the MHz selectors to enter a frequency.
 - 9.2. **PRESET.** Preset mode enables the Preset Channel Selector to set the frequency.
 - 9.3. **GRD.** Guard mode automatically sets the Frequency Status Indicator window to the guard channel.
10. **Function Dial.** Located in the lower left corner of the panel, this four-position dial determines the operational function of the UHF radio.
 - 10.1. **OFF.** When in the OFF setting, no power is sent to the panel.
 - 10.2. **MAIN.** In MAIN mode, the UHF radio acts as a transceiver, meaning that it can monitor the selected channel and broadcast on it.
 - 10.3. **BOTH.** When in the BOTH mode, the UHF radio monitors the guard channel and acts as a transceiver.

- 10.4. **ADF.** The ADF mode allows the UHF radio to act as an automatic direction-finding device. When in this mode, the UHF radio disables guard and transceiver functions. ADF information from the UHF radio will then be sent to the ADI and HSI to provide steering information. No function.
11. **Volume Knob.** Labeled VOL, this dial controls the audio output from the UHF radio.
12. **T-Tone Button.** No function
13. **Squelch Button.** Provides squelch tone.
14. **Load Preset Cover.** Lifting this cover reveals an orange button labeled LOAD. To load a frequency to a preset channel, you simply dial in the frequency manually; select the preset channel you wish to assign the frequency to, and then press the LOAD button.



Figure 113. Load Preset Button

To set a Preset Channel, follow these steps:

1. Set the Frequency Mode Dial to the PRESET setting.
2. Rotate the Preset Channel Selector to the Preset channel that you wish to tie a frequency to.
3. Using the Frequency Selector Knobs, enter the frequency you wish to save to the selected Preset channel.
4. Click on the Load Preset Cover to open it and press the red load button to save.

AN/ARC-186(V) VHF FM Radio 2 Control Panel



Figure 114. ARC-186 Radio Head

This radio operates like Radio 1 but is assigned the VHF FM radio frequency range. The VHF/FM operates between 30.000 and 76.000 MHz. If the radio is tuned to a frequency outside the valid range, a warning tone will be heard.

In most missions, Radio 2 will be used to communicate with JTAC units.

1. **Preset Channel Selector Wheel.** Located along the bottom of the panels, this is a wheel that can move to the left and right. Moving the wheel adjusts the preset channel number displayed in the Preset Channel Indicator window above it. Each of the two radios can store 20 preset channels.
2. **Preset Channel Indicator Window.** This window above the Preset Channel Selector wheel displays the selected preset channel.
3. **Frequency Selector Knobs.** These four knobs are turned clockwise or counterclockwise to set the frequency digit in the field above it.

For VHF/FM, moving left to right, the first knob sets MHz in tens (0-9), the second sets MHz in units, and the remaining two knobs should always be set to 0.

4. **Load Button.** After a frequency has been manually entered, you may press the LOAD button and that frequency channel will be saved to the currently displayed preset channel listed in the Preset Indicator Window.
5. **Volume Knob.** The volume knob in the top left corner of the panel controls initial volume from the radio.

6. **Frequency Mode Dial.** This dial located in the lower right portion of the panel governs the general operational mode of the selected radio. The dial has three positions.
 - 6.1. **OFF.** Disables power to the radio
 - 6.2. **TR.** Places the radio in transmit and receive mode and acts as a transceiver radio for voice
 - 6.3. **DF.** Direction finding mode allows the radio to detect ADF signals and provide steering information to the ADI and HSI. VHF/AM does not have this capability. Not functional.
7. **Frequency Selection Dial.** Consisting of four positions, this dial in the lower left portion of the panel controls the way frequency channels are selected.
 - 7.1. **EMER FM.** When the radio is set to this position, the guard channel is automatically selected. This selection has no effect with VHF/AM.
 - 7.2. **EMER AM.** When the radio is set to this position, the guard channel is automatically selected. This selection has no effect with VHF/FM.
 - 7.3. **MAN.** Manual selection allows you to manually input a frequency using the selector knobs.
 - 7.4. **PRE.** The preset position sets the radio to use the current preset channel listed in the Preset Channel Indicator window.
8. **Squelch Switch.** Provides squelch tone.

To set a Preset Channel, follow these steps:

1. Set the Frequency Mode Dial to the MAN setting.
2. Using the Frequency Selector Knobs, enter the frequency you wish to save as a Preset.
3. Using the Preset Channel Selector Wheel, select the Preset channel that you wish to save the frequency to.
4. Press the Load button.
5. Set the Frequency Mode Dial to the PRE setting.

When you now have the radio in PRE mode, the saved frequency of the Preset channel selected will be used.

Note that when you select a Preset channel, the frequency tied to that Preset channel will NOT be displayed in the frequency display windows. Only the MAN frequency is displayed there.

KY-58 Secure Voice Control Panel

The KY-58 secure voice panel allows encryption and decryption of voice communication over the VHF and UHF radios. When in combat, transmission of secure voice allows you to be sure the enemy is not listening in on your communications in a multiplayer game!

This panel is non-functional in this simulation.



Figure 115. KY-58 Panel

1. **Power Switch.** Move this switch to the ON position to enable voice encryption of the selected radio.
2. **Mode Dial.** This dial controls the main operating mode of the KY-58 but will generally be left in the Operation (OP) setting. OP allows transmission and reception of encrypted communications. The LD (Load) position allows loading of cipher keys manually using a transfer device. The RV (Receive Variable) position allows loading of cipher keys remotely via radio.
3. **Radio Select Dial.** This is a three-position dial that determines which radios have their data encrypted.
4. **C/RAD 1** encrypts UHF communications
5. **PLAIN** removes encryption from all radios (Plain Voice)
6. **C/RAD 2** encrypts VHF communications
7. **Encryption Code Preset.** Six encryption codes are preset to the six selections on this dial. For you to transmit and receive encrypted data with another entity, both you and the sender/receiver must be set to the same code preset.
8. **Delay Switch.** No function

9. **Zeroize Switch.** When the switch guard is raised and the switch enabled, the six secure voice crypto-variables are erased. Note that if you do this, you will not be capable of conducting secure communications.

Emergency Brake System



Figure 116. Emergency Brake System

If the left hydraulic system fails, the EMER BRAKE handle can be used to supply hydraulic pressure to the wheel brakes from the right hydraulic system. If both hydraulic systems fail, the emergency braking system uses hydraulic pressure from a dedicated accumulator. The accumulator is fed from the right hydraulic system and stores sufficient pressure for five brake applications.

Auxiliary Lighting Control Panel



Figure 117. Auxiliary Lighting Control Panel

1. **Refueling and Indexer Lights Dial.** Located in the top left corner of the panel, the REFUEL STATUS & INDEXER LTS dial allows you to adjust the brightness of the AoA indexer on the left canopy bow and the refueling status lights. Rotate the dial to adjust between DIM (little brightness) and BRT (full brightness).
2. **NVIS and NVIS Lights Switch.** To support night vision devices, the A-10 uses lights on the fuselage, wingtips and tail that are night vision compatible. The Night Vision Imaging System (NVIS) switch, labeled NVIS LTS, has three positions: The up position labeled TOP turns on the top fuselage NVIS light; the middle ALL position turns on all NVIS lights and the button OFF setting turns all NVIS lights off. No function is this simulation.
3. **Signal Light Test Button. Button and test lamp.** With the SIGNAL LIGHT LAMP TEST button, the illumination of lights can be tested. When only battery power is on, the following lights will be illuminated if the button is held down:
 - STEERING ENGAGED
 - MARKER BEACON
 - CANOPY UNLOCKED
 - MASTER CAUTION
 - Landing gear condition (L-SAFE, N-SAFE, R-SAFE)
 - Landing gear handle (LDG GEAR DOWN)
 - Emergency flight control panel (L-AIL, R-AIL, L-ELEV, R-ELEV)

- SAS control panel (TAKEOFF TRIM)
- Caution light panel

All other lights require power from the generators, converters, or some external source:

- GUN READY
 - NMSP buttons (HARS, EGI, TISL, STR PT, ANCHR, TCN, ILS, UHF HOMING, and FM HOMING)
 - AoA indexers - test bright only, regardless of signal light switch position.
 - Aerial refueling status lights (READY, LATCHED, DISCONNECT) - test bright only, regardless of signal light test switch position.
 - TISL lights (TISL/AUX, OVERTEMP, DET/ACD, TRACK) (if pod installed and on)
4. **Weapon Station Dimmer Dial.** With the move of ACP functions to the MFCDs of the A-10C, this control has no function in the A-10C now.
 5. **HARS/SAS Override.** Also located on this panel is the HARS/SAS Override switch. If HARS is active and is feeding bad information to the SAS system, the SAS will automatically disable itself if this switch is in the NORM position. If in the OVERRIDE position though, SAS will continue to function regardless of faulty HARS input data.
 6. **Fire Detect Bleed Air Leak Test.** Pressing this button will test the fire detection system. This is visually indicated by the lit T-Handles.

Stability Augmentation System (SAS) Panel

Flight control in the A-10C is provided by a series of redundant pushrods and hydraulic systems that actuate the ailerons (roll), elevators (pitch) and rudders (yaw). Loss of a single hydraulic system will not disable control, but the level of response will decrease depending on the control surface.

Pitch control is provided by two elevators at the tail of the plane. In addition to a direct link pushrod from the cockpit, the two connected elevators are both powered by hydraulic system actuators. As such, if you lose one of the hydraulic systems, the other system will handle the load of the other via a shareable, linking shaft. If one of the two elevators' actuators becomes jammed, that linkage can be disabled, and you can fly with the still-operational elevator. Pitch trim is provided by electrically driven trim tabs on the ends of the elevators.

Roll control is provided by an aileron on each wing. As with the elevators, the ailerons are powered by both hydraulic systems to provide control redundancy. As a failure backup, the trim tabs can also be used to fly the aircraft in the Manual Reversion Flight Control System (MRFCS). Roll trim is provided by trim tabs on the trailing end of the ailerons.

Yaw control is provided by two rudders, both powered by the two hydraulic systems. The rudders are controlled in unison by a single cable to the actuators.

To help dampen and improve flying characteristics in pitch and yaw, the A-10C is equipped with the Stability Augmentation System (SAS). SAS also provides you automatic turn coordination (adding the proper amount of rudder input when banking the aircraft). The SAS assists in making the A-10C a very stable gun platform.

Note though that SAS relies upon hydraulic power, and the loss of hydraulics will result in the automatic disengagement of the SAS channels.



Figure 118. SAS Panel

SAS is a two-channel flight augmentation system that enhances control in both pitch and yaw. As noted earlier, SAS helps to provide coordinated turns, pitch, and yaw rate dampening, pitch trim compensation, and makes the A-10C a more stable aircraft to fly. Additionally, systems like PAC use SAS to adjust pitch and yaw when engaged to PAC 1 and PAC 2 up to 10°.

1. **Yaw Trim Control Knob.** This knob located on the left side of the SAS panel allows you to set yaw trim bias when SAS in enabled. Rotate the knob left or right depending on the desired direction of yaw trim bias.
2. **Takeoff Trim Control Button.** Labeled T/O TRIM, pressing this button will automatically set all trim tabs to neutral, takeoff settings. When all trim tabs have been set to the proper setting, the takeoff trim light above the button will light and indicate TAKEOFF TRIM.
3. **SAS Pitch Engage Switches.** These two switches activate pitch channel SAS. Moving both switches to the ENGAGE position enables the pitch SAS channels.

4. **SAS Yaw Engage Switches.** These two switches activate yaw channel SAS. Moving both switches to the ENGAGE position enables the yaw SAS for both channels.
5. **Monitor Test Switch.** No function

Identify Friend or Foe (IFF) Panel

IFF was first developed in World War II to electronically identify aircraft that were beyond visual range. An IFF sends out an encrypted interrogation signal that a friendly aircraft will reply with the correct electronic response. If the interrogated aircraft does not send back the correct signal, it is assumed hostile.

This panel is non-functional in this simulation.

While the A-10C cannot interrogate other aircraft with IFF, it can respond to IFF interrogations. The A-10C has five IFF modes it can respond with:

- **Mode 1.** This mode has 64 reply codes and is to determine the type of aircraft that is answering and what type of mission it is on.
- **Mode 2.** This mode has 4,096 possible reply codes and is used to answer the interrogation with the aircraft's tail number.
- **Mode 3/A.** This is the standard air traffic control mode. This transponder code allows tracking of the aircraft under instrument flight rules conditions and is used by both civilian and military aircraft.
- **Mode C.** This mode uses 3/A but also responds with barometric pressure altitude information of the interrogated aircraft.
- **Mode 4.** Mode 4 incorporates encryption of the IFF signal reception and response.

Control of the A-10C IFF system is done on the IFF panel with the following controls:



Figure 119. IFF/SIF Control Panel

1. **Master Mode Dial.** This dial controls power to the IFF system and basic receiver sensitivity. The dial has five positions:
 - 1.1. **OFF.** Remove power to the IFF system.
 - 1.2. **STBY.** Places the IFF in a powered-up, ready state but does not receive IFF signals.
 - 1.3. **LOW.** IFF receivers are at low sensitivity setting.
 - 1.4. **NORM.** IFF receivers are at normal operating level of sensitivity.
 - 1.5. **EMER.** No function.
2. **M-1 Switch.** Move to the ON position to enable Mode 1 IFF interrogations.
3. **M-2 Switch.** Move to the ON position to enable Mode 2 IFF interrogations.

4. **M-3/A Switch.** Move to the ON position to enable Mode 3/A IFF transponder.
5. **M-C Switch.** Move to the ON position to enable Mode C IFF transponder.
6. **Radiation Test Monitor Switch.** No function.
7. **Identification of Position Switch.** No function.
8. **Mode 1 Code Select Wheels.** Rotate the two wheels to enter the two-digit Mode 1 code. Valid codes range from 00 to 73.
9. **Mode 3/A Code Select Wheels.** Rotate these four wheels to enter the four-digit Mode 3/A code. Each digit can be set between 0 and 7.
10. **Mode 4 Switch.** Place this switch in the ON position to enable encrypted IFF response.
11. **Audio Light Switch.** When interrogated in Mode 4, this switch is in either the OUT or AUDIO position, the IFF interrogation tone is heard. If in the LIGHT position, the REPLY light will light when interrogated and replied to.
12. **Code Dial.** No function.
13. **Reply Light.** This light will light when replying to a Mode 4 interrogation.
14. **Test Light.** This light will light when the test mode of Mode 1, Mode 2, Mode 3/A, or Mode C is conducted. The light will remain on when depressed.

Emergency Flight Control Panel



Figure 120. Emergency Flight Control Panel

The Emergency Flight Control (EFC) panel located on the left console allows you to adjust the flight control systems in emergency situations. In normal flight, this panel would not be used. Elements of this panel include:

1. **Pitch/Roll Trim Switch and Emergency Pitch and Roll Switch.** Located in the top center of the panel, this two-position switch is labeled PITCH/ROLL TRIM. When this switch is in the NORM position, trim is controlled by the trim hat on the control stick. When the switch is in the down, EMER OVERRIDE position, trim is set by adjusting the Emergency Pitch and Roll switch located to the right.
2. **Speed Brake Emergency Retract.** Labeled SPD BK EMER RETR, this is a two-position switch. When in the down position, speed brake control is governed by the speed brake control on the throttle. When in the up position, the speed brakes are closed using aerodynamic pressure.
3. **Flap Emergency Retract.** Labeled FLAP EMER RETR, this is a two-position switch. When in the down position, flap control is governed by the flap control on the throttle. When in the up position, the flaps are closed using aerodynamic pressure.
4. **Aileron Emergency Disengage Switch.** In the event one of the two linked ailerons becomes inoperative, you may need to disable it so that the other aileron can still function. To do so, you may move the AILERON EMER DISENGAGE switch left or right to disengage the selected aileron actuator. This will bypass the inoperative control path and allow the other aileron to move freely.
5. **Elevator Emergency Disengage Switch.** In the event one of the two linked elevators becomes inoperative, you may need to disable it so that the other elevator can still function. To do so, you may move the ELEVATOR EMER DISENGAGE switch left or right to disengage the selected elevator actuator. This will bypass the inoperative control path and allow the other elevator to move freely.
6. **Manual Reversion Flight Control System (MRFCS) Switch.** If the aircraft has suffered dual hydraulic system failure, the MRFCS is a backup control system using direct cable linkages to the pitch and yaw control surface actuators. Roll control is provided through the aileron trim tabs. This provides the ability for moderate maneuvering. MRFCS is activated by placing the MRFCS switch in the MAN REVERSION position (down). When in the up FLT CONT NORM position, flight input control acts normally.

Intercom Control Panel



Figure 121. Intercom Control Panel

The Intercom system panel is a single interface between you and the various navigation and radio systems regarding their audio input/output. While each of these navigation and radio systems has their own audio (volume) controls, the Intercom panel overrides their settings. Additionally, the Intercom panel can control the volume level of tones associated with LASTE such as pull up, altitude, etc. and it allows communication with ground crew (needed for arming and refueling your aircraft).

1. **Volume Control Knob.** Labeled VOL on the panel, this knob acts as a master volume control and affects all other audio level settings on the panel.
2. **HM (hot mic) Switch.** Labeled HM, the Hot Mic button allows you to communicate with the ground crew and tanker. However, for this function to work the Rotary Selection dial must first be set to INT (intercom) and the INT button must be selected.
3. **INT Switch.** This is a two position (in or out) button that enables communication to the ground crew or tanker. Once this switch is enabled, you must press the HM button to initiate communication.

4. **AIM Switch.** This is a two position (in or out) button that enables audio from the AIM-9 Sidewinder seeker to be heard. To hear such audio, the AIM-9 Mode Switch must first be set in the SELECT position.
5. **FM Switch.** This is a two position (in or out) button that enables you to monitor audio from the VHF/FM receivers. Rotary Selector position will not matter.
6. **VHF Switch.** This is a two position (in or out) button that enables you to monitor audio from the VHF/AM receivers. Rotary Selector position will not matter.
7. **ILS Switch.** This is a two position (in or out) button that enables you to hear the localizer and marker beacons when ILS is enabled.
8. **UHF Switch.** This is a two position (in or out) button that enables you to monitor audio from the UHF receivers. Rotary Selector position will not matter.
9. **TCN Switch.** This is a two position (in or out) button that enables you to receive the TACAN signal being broadcasted by the selected station. This signal is the name of the station in Morse code.
10. **Rotary Selector Dial.** This four-position dial allows you to select which transmitter you wish to broadcast on and monitor. Selections are INT, VHF, FM, and HF. As such, to send a radio message using one of the radios or intercom to ground crew or tanker, you must first set this dial to the transmitter you wish to use.
11. **IFF Switch.** Adjust volume of interrogation tone.
12. **Call Switch.** No function.

Stall Warning Control Panel



Figure 122. Stall Warning Control Panel

When the aircraft is within 2 angle of attack units of a stall, a steady warning tone is sounded. When the aircraft is 1 angle of attack unit or less of entering a stall, the tone will become chopped. When you hear the chopped tone, it is best to reduce angle of attack immediately.

From the Stall Warning Control panel, you may control the volume of these two tones. The dial labeled STALL controls the volume of the chopped tone and the PEAK PRFM dial controls the volume of the steady tone. Only the PEAK PRFM tone can be reduced to zero though.

Right Console

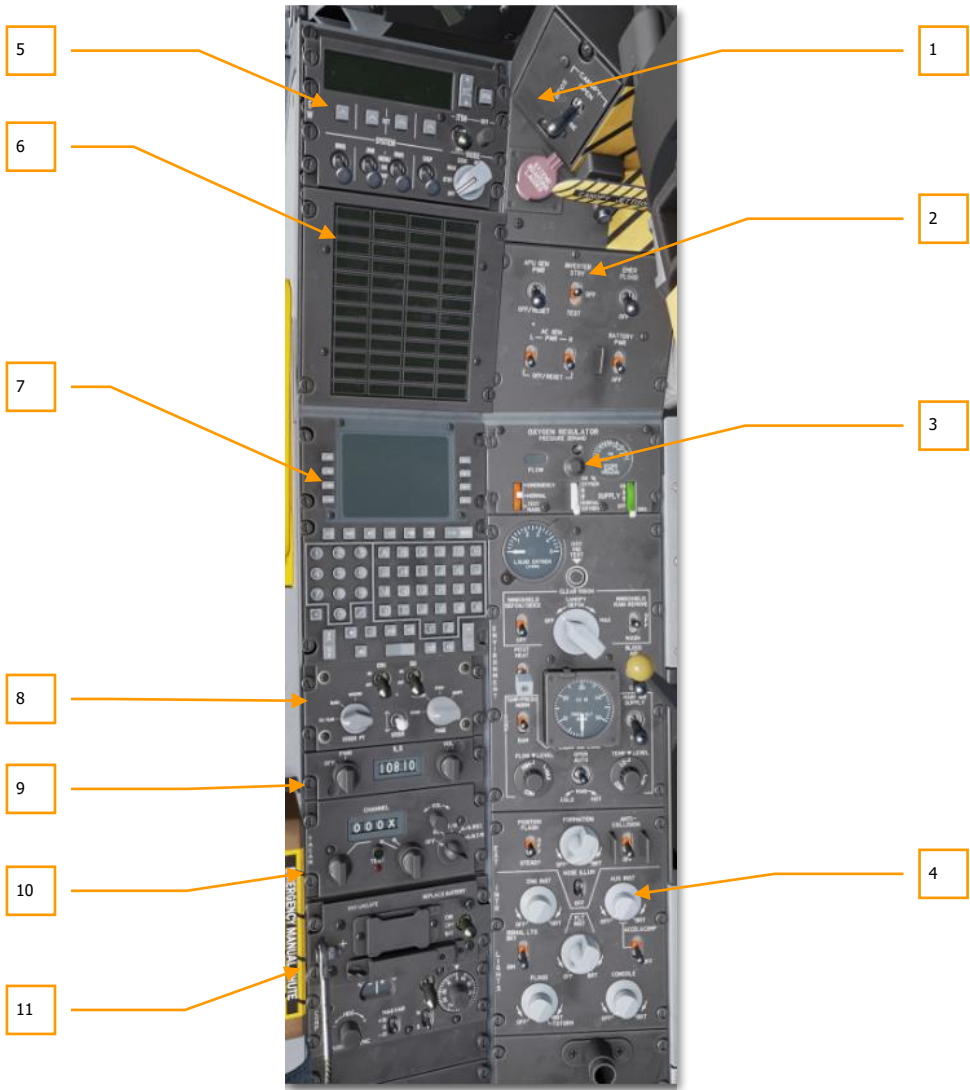

Figure 123. Right Console

The right console of the cockpit includes a variety of controls, but the most common ones you will probably use are the CDU and AAP for navigation purposes. This console remains largely unchanged from late-model A-10A models.

1. Cockpit canopy switch
2. Electrical power panel
3. Environment system panel
4. Lighting control panel
5. Countermeasures Signal Processor (CMSP) panel
6. Caution light panel
7. Control Display Unit (CDU)
8. Auxiliary Avionics Panel (AAP)
9. TACAN operation and control panel
10. Instrumented Landing System (ILS) control panel and ILS operation
11. Helmet-Mounted Cueing System control panel

Cockpit Canopy Switch and Canopy Ejection Handle

Made of acrylic plastic, the canopy can be opened and closed from within the cockpit using the cockpit canopy control switch. In an emergency, the canopy can be jettisoned using the canopy jettison handle.

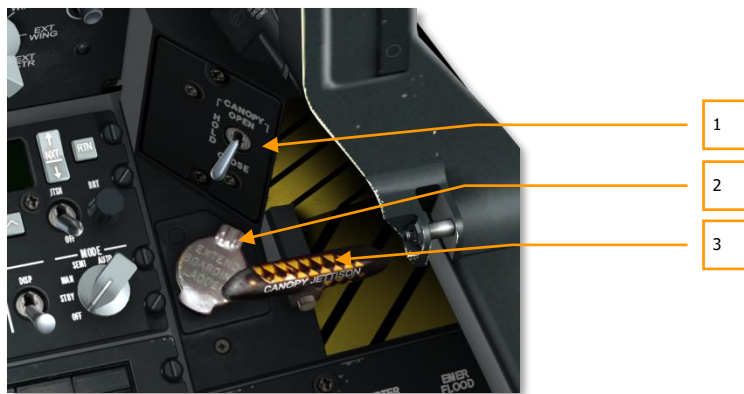

Figure 124. Canopy Switch and Ejection Handle

1. **Canopy switch.** This three-position switch labeled CANOPY, allows you to normally open and close the canopy. When held on the OPEN position, the canopy will be raised; when held in the CLOSE position, the canopy will lower; and when in the HOLD position, the canopy will stay at its current position.

Until the canopy is in a full closed position, the canopy unlock light on the front dash will be lit.

2. **Boarding ladder button.** Once the cover is raised, pressing the red button will lower the boarding ladder. To raise the boarding ladder, the ground crew must be contacted over the intercom and issued the raise ladder command.
3. **Canopy Jettison handle.** Located adjacent to the cockpit canopy control switch is the canopy jettison handle. This black and yellow striped handle is activated to explosively jettison the canopy.

Electrical Power Panel

The A-10C has requirements for both AC and DC power. This electrical power is needed to run the engines, instrumentation, and other avionics systems. In this simulation, electrical power will be provided through the onboard battery, Auxiliary Power Unit (APU), and the generators. Providing the necessary electrical power will be the first step in bringing the aircraft to life from a cold start.

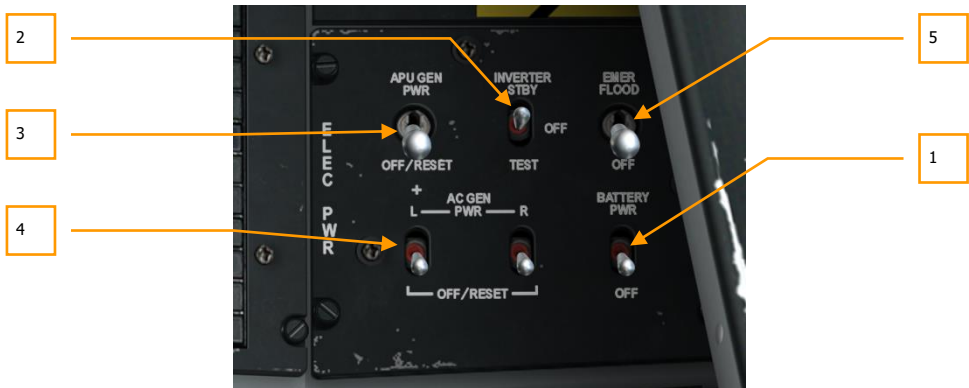

Figure 125. Electrical Power Panel

Located in the forward right portion of the right console, the electrical power control panel provides you with the primary electrical power and conversion controls. The panel consists of a variety of two- and three-place switches.

1. **Battery Power Switch.** The aircraft carries a 24-volt battery that can provide DC and AC power to the aircraft. This DC power can be used to start the Auxiliary Power Unit (APU) and AC power for basic engine instrumentation. This is a two-place switch in the lower-right portion of the panel. Setting this switch to PWR is the first step in starting the aircraft.
2. **AC Instrument Inverter.** With the on-board battery set to PWR, you may set this switch in the top center of the panel to the STBY position to supply AC-powered engine instruments.
3. **APU Generator Power.** After the APU has been started, the APU GEN switch can be set to the PWR position. This allows DC and AC power generated by the APU to take over the electrical load being carried by the battery. Once both engines are fully operating and are providing power through their generators, the APU can be turned off.
4. **AC Generators.** Once the engines are operating and powering the two generators, the AC power generated by them needs to be supplied to all the AC buses. In the lower left portion of the panel, left and right switches allow you to do so.
5. **Emergency Flood.** Located on the Electrical Systems panel, this two-position switch turns on both flood lights to full brightness when moved to the EMER FLOOD position. These lights may be disabled by moving the switch to the OFF position.

Environment System Panel



Figure 126. Environment System Panel

The Environment System panel consists of two primary sections. The top half is the oxygen regulator, and the bottom half are various controls for air temperature, pressurization, and canopy heating.

Oxygen Regulator

1. **Supply Lever.** The green-colored supply lever has two positions, On and Off. When in the On position, oxygen is supplied to you.
2. **Dilution Lever.** This lever can be toggled to 100% oxygen and normal oxygen which is diluted to increase total supply time.

3. **Emergency Lever.** This red-colored lever has positions for normal operation, mask test, and emergency. Given the nature of this simulation, only normal mode is modeled.
4. **Oxygen Flow Indicator.** This small window flashes back and forth between black and white in accordance with each breath.
5. **Oxygen Supply Pressure.** This hemi-sphere indicator shows the current psi of the regulator.
6. **Oxygen Quantity Indicator.** This gauge indicates the quantity of liquid oxygen in the regulator. The gauge scales between 0 and 5 liters.
7. **Oxygen Indicator Test Button.** When this button is held down and the system is operating normally, the needle on the Oxygen Quantity Indicator will spin and the oxygen low level light on the caution panel will illuminate when oxygen quantity falls below 0,5 liters.

Note: It will be important that you mind your oxygen supply. If it runs out and you are above 18,000 feet, you will suffer the effects of hypoxia and lose consciousness.

Air and Pressure Controls

4. **Windshield Defog/Deice Switch.** The windshield heater is controlled by this switch and is used to combat windshield fogging and icing.
5. **Pitot Heater Switch.** When in the PITOT HEAT position, the pitot is heated to prevent icing. You will want to enable this shortly before takeoff to avoid pitot icing. A blocked pitot tube could result in a CADC failure message.
6. **Windshield Rain Removal and Wash Switch.** This is a three-place switch that allows the windshield to be washed with a solution when in the down position or be blown with bleed air in the up position. The middle position sets the system to OFF. No function.
7. **Bleed Air Switch.** When in the up position, bleed air from the engines and APU can be routed to the environmental systems.
8. **Canopy Defog Dial.** This dial may be rotated to control the amount of bleed air being blown from the base of the canopy.
9. **Temperature/Pressure Control Switch.** This switch controls source of air temperature and pressure between normal, dump and RAM.
10. **Flow Level Dial.** Rotating this dial controls the amount of air coming into the cockpit from the air conditioning system.
11. **Main Air Supply Switch.** This is a two-position toggle switch used to provide alternate closure of ECS valve which shuts off engine bleed air to Environment Control System but does not shut off ram air.

12. **Temperature Level Control.** This dial allows you to control the air temperature of the cockpit. No function.
13. **Air Conditioner Control Switch.** This switch allows you either manual or automatic control of the air conditioner system.
14. **Cabin Air Pressure Gauge.** Current air pressure of the cockpit.

Lighting Control Panel

This panel is in the rear area of the right console and is your primary means of controlling external and internal aircraft lighting. The top portion of the panel is dedicated to external lighting and the bottom portion is used for internal, cockpit lighting.

It is important to note that the Master Exterior Light Switch setting (Pinky Switch on HOTAS) on the left throttle may override panel settings.

Pinky Switch Forward: Sets external lights to default settings.

- Retains set illumination levels for formation lights, nose floodlights, and nacelle floodlights.
- Position lights set to steady.
- Disables anti-collision lights.

Pinky Switch Center: Turns off all external lights.

Pinky Switch Aft: Lights are according to Lighting Control Panel settings.



Figure 127. Light Control Panel

- Position Lights and Switch.** There are three position lights on the A-10C, a red light on the left wingtip, a green light on the right wingtip, and a white light on the tail. In the top left portion of the Lighting Control panel is three-position switch labeled POSITION. The three settings are:
 - FLASH** (up) which turns the position lights off and on repeatedly
 - OFF** (center) which turns off all the position lights
 - STEADY** (down) which turns on all position lights
- Anti-Collision Lights and Switch.** The A-10C has three anti-collision strobe lights: one on each wingtip and one on the tail. The switch to control these lights is located in the top right corner of the panel and has two positions, ANTI-COLLISION (up) and OFF (down).

3. **Formation Lights and Dial.** Located on the vertical tails, on the fuselage, and on the wingtips are yellow-green luminescent formation lights. These lights are useful when attempting to hold close formation at night and are not visible from long range. To control the brightness of these formation strips, you can use the FORMATION dial. The dial can be rotated between the OFF and BRT (bright) stops.
4. **Nose Floodlight and Nose Illumination Switch.** Installed on each wing are floodlights that are angled to illuminate the forward section of the fuselage. These can be used to help keep formation and assist in aerial refueling. These are turned off and on with the other formation lights. However, using the NOSE ILLUM switch, you may turn them off and on independently of the other formation lights.
5. **Engine Instruments Lights Dial.** This dial controls the brightness of panel lights for engine instruments that include:
 - ITT indicators
 - Engine oil indicators
 - Engine fuel flow indicators
 - Engine core speed indicators
 - Engine fan speed indicators
 - APU tachometer
 - APU temperature gauge
 - The dial can be rotated from OFF (no lighting) to BRT (full brightness).
6. **Flight Instruments Lights Dial.** This dial controls the brightness of panel lights for flight instruments that include:
 - ADI
 - HSI
 - Airspeed indicator
 - VVI
 - AOA indicator
 - Navigation mode select switches
 - Altimeter

The dial can be rotated from OFF (no lighting) to BRT (full brightness).
7. **Auxiliary Instruments Lights Dial.** This dial controls the brightness of panel lights for auxiliary instruments that include:
 - Hydraulic pressure gauges
 - Flap position indicator
 - Fire extinguisher panel

- Fuel quantity panel and indicator
- Emergency jettison lighting plate
- Standby compass
- SAI
- Accelerometer
- Landing gear control panel
- LASTE control panel

The dial can be rotated from OFF (no lighting) to BRT (full brightness).

8. **Signal Lights Switch.** This two-position switch located on the left side of the panel is labeled SIGNAL LTS and is used to set warning and caution advisory lights to one of two settings: the BRT setting provides full brightness, and the DIM setting is used to provide reduced illumination.
9. **Accelerometer and Compass Light Switch.** Located on the right side of the panel is the two-position ACCEL & COMP switch. This switch provides lighting to the accelerometer and compass on the front canopy bow. Placing the switch in the up position turns on the lights and moving the switch to the down position turns them off.
10. **Floodlight Dial.** Labeled FLOOD, this dial controls the brightness of the two flood lights located on either side of the cockpit. The dial can be set from OFF (no lighting) to BRT (full brightness). The dial can be moved past BRT to the TSTORM setting which will shade all flood lights.
11. **Console Light Dial.** This dial controls the brightness of panel lights for flight instruments that include:
 - Emergency flight control panel
 - Throttle quadrant panel
 - SAS panel
 - Fuel system control panel
 - Canopy control
 - Seat control
 - UHF radio panel
 - VHF/FM radio panel
 - VHF/AM radio panel
 - Intercom control panel
 - IFF control panel
 - Antenna select control panel
 - Circuit breaker panel
 - ILS control panel
 - TACAN control panel
 - HARS control panel

- Oxygen control panel
- Environmental control panel
- Lighting control panel
- CDU
- AAP

The dial can be rotated from OFF (no lighting) to BRT (full brightness).

Caution Light Panel



Figure 128. Caution Light Panel

The Caution Light Panel, located on the right console, alerts you to any abnormal system behaviors. When such an event occurs, an indication will be listed on the panel. The caution indication cannot

be removed until remedial action has been taken to correct the root of the caution. Any time a caution event occurs, the Master Caution light will light on the UFC.

Below is a list of caution events and how they may be triggered:

ENG START CYCLE	If either engine is in engine start process
L-HYD PRESS	If left hydraulic system pressure falls below 1,000 psi
R-HYD PRESS	If right hydraulic system pressure falls below 1,000 psi
GUN UNSAFE	If gun is capable of being fired
ANTI SKID	If landing gear is down but anti-skid is disengaged. No function
L-HYD RES	If left hydraulic fluid reservoir is low
R-HYD RES	If right hydraulic fluid reservoir is low
OXY LOW	If oxygen gauge indicates 0,5 liters or less.
ELEV DISENG	If at least one elevator is disengaged from the Emergency Flight Control panel
AIL DISENG	If at least one aileron is disengaged from the Emergency Flight Control panel
SEAT NOT ARMED	If ground safety lever is in safe position. No function
BLEED AIR LEAK	If bleed air is 400° F or more
L-AIL TAB	If left aileron is not at normal position due to MRFCs
R-AIL TAB	If right aileron is not at normal position due to MRFCs
SERVICE AIR HOT	If air temperature exceeds allowable ECS range. No function
PITCH SAS	If at least one pitch SAS channel has been disabled
YAW SAS	If at least one yaw SAS channel has been disabled
L-ENG HOT	If left engine ITT exceeds 880° C
R-ENG HOT	If right engine ITT exceeds 880° C
WINDSHIELD HOT	If windshield temperature exceeds 150° F. No function
L-ENG OIL PRESS	If left engine oil pressure is less than 27.5 psi
R-ENG OIL PRESS	If right engine oil pressure is less than 27.5 psi
GCAS	If LASTE failure detected that affects GCAS
L-MAIN PUMP	If boost pump pressure from left main tank is low

R-MAIN PUMP	If boost pump pressure from right main tank is low
L-WING PUMP	If boost pump pressure from left wing tank is low
R-WING PUMP	If boost pump pressure from right wing tank is low
L-MAIN FUEL LOW	If left main fuel tank has 500 pounds or less
R-MAIN FUEL LOW	If right main fuel tank has 500 pounds or less
L-FUEL PRESS	If low fuel pressure detected in left engine fuel feed lines
R-FUEL PRESS	If low fuel pressure detected in right engine fuel feed lines
L-CONV	If left electrical converter fails
R-CONV	If right electrical converter fails
L-GEN	If left generator has shut down or AC power is out of limits
R-GEN	If right generator has shut down or AC power is out of limits
LASTE	If fault detected in LASTE computer
IFF MODE-4	If inoperative mode 4 capability detected. No function
EAC	If EAC is turned off
STALL SYS	If there is a power failure to the AoA and Mach meters
APU GEN	If APU generator is off-line with APU generator switch set in PWR
INU AIR HOT	If air temperature is too hot for INU. No function
HARS	If HARS heading or attitude is invalid
L-R TKS UNEQUAL	If there is a 750-pound difference between the two main fuel tanks
INERTIAL NAV	If there is a CDU failure while in alignment mode
CADC	If CADC has failed
INST INV	If AC powered systems are not receiving power from inverter

For a complete list of remedy actions, please consult the Emergency Procedures chapter.

TACAN Operation and Control Panel



Figure 129. TACAN Control Panel

TACAN provides you line-of-sight bearing and range to selected TACAN ground stations. TACAN is often a useful means to quickly get navigation data to friendly airfields. Additionally, some aircraft can broadcast TACAN beacons as well. For air-to-air TACAN in the A-10C, only range data can be passed between A-10C. The KC-135 can provide both range and bearing.

In A/A mode between two A-10C, the channel selected by the interrogating aircraft must be 63 channels (MHz) above or below the channel selected by the replying aircraft to provide the correct frequency for the mixer in the receiver circuit. If one selects channel 1Y, another aircraft should select 64Y to make it work. Further, Channel 1X or 1Y, transmitting at 1025 MHz, shall receive at 1088 MHz and pair with channel 64X or 64Y transmitting at 1088 MHz and receiving at 1025 MHz. Channel 2X or 2Y, transmitting at 1026 MHz, shall receive at 1089 MHz and pair with channel 65X or 65Y transmitting at 1089 MHz and receiving at 1026 MHz.

When the Navigation Mode Select Panel is set to TCN and the TACAN Control Panel has been properly configured, range and bearing information from a selected TACAN ground station and KC-135 will be displayed on the HSI in regards to Bearing Pointer 1 and Range indicators.

The TACAN Control Panel is located on the right console behind the CDU and AAP.

1. **Mode Dial.** Located on the right of the panel, this dial has five selections:
 - 1.1. **OFF.** Disables power to the TACAN system
 - 1.2. **REC.** The system operates in receive mode only. In this mode, it can receive bearing, course deviation and station identification only
 - 1.3. **T/R.** Transmit / Receive mode operates as REC mode but also supplies range information

- 1.4. **A/A REC.** The system receives only air-to-air bearing TACAN signal. This would be used to locate aerial tankers.
- 1.5. **A/A T/R.** This mode allows the two-way transmission of TACAN range and bearing data between two aircraft.
2. **Channel Selector Switches.** The two rotary switches are each used to set a value from 0 to 9. When used together, they can display a two-digit TACAN channel identification. Adjust the value by placing the cursor on the switch and rotating the mouse wheel.
3. **Channel Display Window.** Using the channel selector switches, the selected channel is displayed in this window. Right click on the switch to set either the numeric value (from 0 - 9) or the X/Y value. Once selected, place the cursor over the switch and rotate the mouse wheel to set the value.
4. **Test Button.** Tests the TACAN system as indicated on the HSI.
5. **Volume Knob.** Rotating this knob adjusts the volume of the TACAN audio signal.

ILS Control Panel and ILS Operation



Figure 130. ILS Control Panel

Primarily used for Instrument Flight Rules (IFR) landings at night and/or foul weather, the ILS system provides a localizer signal that can be displayed on the HSI and glide slope indications on the ADI. In addition to indications on the HSI and ADI, you will also hear the audio indication that the localizer signal has been captured. Upon approaching the runway threshold, there will also be an audio cue after passing over a marker beacon.

Note that you can locate airfield ILS frequencies on the CDU DIVERT page.

To hear the localizer and marker beacon tones, you will need to enable the ILS switch on the Intercom Panel.

1. **Power Control Knob.** This two-position switch controls power to the ILS system. Setting the switch to PWR with the outside of the knob enables power and setting the switch to OFF will

disable power. Rotating the base of the knob will cycle the ILS frequency (displayed in the ILS Setting Window), by increments of 1 whole numbers.

2. **Volume Knob.** Labeled VOL, the dial controls the volume of the localizer capture tone and the marker beacon tone. To adjust volume, the outside of the knob is rotated. If the base of the knob is rotated, the ILS frequency in tenths and hundredths will be cycled in .05 increments.
3. **ILS Setting Window.** This transparent window displays the current ILS frequency setting. Above the window is an ILS label.

Heading and Attitude Reference Systems (HARS) Control Panel



Figure 131. HARS Control Panel

Located in the back portion of the right console, the HARS Control Panel allows you to adjust HARS derived data.

1. **SYN-IND annunciation.** This window labeled SYN on the left side and IND on the right indicates the level of synchronization between the HARS and the remote compass when in slave mode. The needle in the center will always be centered to indicate proper alignment.
2. **Mode Switch.** This two-position switch can be either set to SLAVE or DG. Normal mode is SLAVE and aligns the HARS gyro to the remote compass transmitter. As such, it acts as a standard gyro-stabilized magnetic compass. If placed in the DG (directional gyroscope) position, the HARS gyro is disconnected from the remote compass transmitter and can be adjusted manually.
3. **LAT Correction dial.** To account for gyro drift according to the current latitude, this dial labeled LAT is rotated to the aircraft's current latitude.

4. **Hemisphere Selector Switch.** The hemisphere select switch has two positions, N and S. To account for earth rotation, the switch should be set according to aircraft's hemisphere latitude.
5. **Magnetic Variation Switch.** This switch labeled MAG VAR has three positions, +15, 0 and -15. You will set the switch to the setting that best matches the magnetic variation of the aircraft's location.
6. **Sync Button.** To quickly align the HARS gyro and see results on the ADI and HSI, you can press this button in the lower left corner of the panel. Rotating the switch, you can in turn control heading as indicated on the HSI.

Helmet Mounted Cueing System (HMCS) Control Panel



Figure 132. HMCS Control Panel

Power to the Scorpion HMCS is controlled from the control head in the back of the right console. A single switch has options for:

- **ON.** Power to the HMCS through the aircraft electrical power supply system.
- **OFF.** Power removed from the HMCS.
- **BAT.** Power to the HMCS using a battery stored in the panel. This allows it to be tested without need of aircraft electrical power.

Embedded GPS/INS (EGI) Navigation System

The EGI (often pronounced 'igee') navigation system is the primary aircraft navigation system of the A-10C and provides accurate, worldwide, navigation capability, as well as attitude and steering

information. There are two primary panels associated with the EGI: the Control Display Unit (CDU) and Avionics Auxiliary Panel (AAP). EGI operations revolve around a set of waypoints and flight plans that are stored in the CDU. This waypoint and flight plan database is generally created beforehand in the mission editor/planner, but it can also be modified during a mission. Up to 2,077 waypoints can be stored in the waypoint database. The waypoint database is divided into 4 parts:

Waypoint Database

The EGI system provides point-to-point navigation with a maximum of 40 waypoints stored in each flight plan plus 25 letter markpoints. You can have up to 20 unique flight plans.

Flight Plan Waypoints

- Assigned waypoint numbers 0 through 40.
- Mission waypoint 0 is normally the takeoff location.
- Is loaded automatically from the mission editor or manually entered before or during the flight using the CDU.

Markpoints

- Assigned waypoint letters A through Y (25 total).
- Can be copied to the mission waypoint database using waypoint (WAYPT) pages and then modified as a new mission waypoint.
- There are two types of markpoints: an overhead mark and an offset mark. An overhead mark records the current aircraft position while an offset mark records the coordinates and elevation of a point identified by a sensor like the targeting pod.
- When an overhead or offset markpoint is created, the CDU will automatically branch to the waypoint page to display the data for the new markpoint. This provides you with instant feedback concerning the new markpoint. It is important to note that the CDU will not branch to the waypoint page if a Mark Z (weapon release) is currently being displayed.
- If all 25 markpoints are in use and another mark is taken, it will overwrite Mark A; subsequent marks will follow the same logic as above.

Flight Plans

- The CDU can store 20 flight plans with up to 40 waypoints each. A flight plan is automatically created in the mission editor or in the CDU.
- Functions only when STEER PT rotary switch on the avionics auxiliary panel (AAP) is in the FLT PLAN position.
- You can insert new waypoints into a flight plan while flying a mission.
- Waypoint Database Fields. Each waypoint is created with the following set of values:

- **Waypoint Number:** Number from 0 to 40 or letter from A to Z. No two waypoints can have the same number/letter. These are automatically set as mission waypoints in the mission editor or can be created while in a mission.
- **Waypoint Identifier Name:** Maximum of 12 alphanumeric characters; first character must be a letter. No special characters other than numbers or letters allowed in name except a period ("."). No two waypoints can have the same identifier. Set in mission editor or with the CDU during a mission.
- **Waypoint Type:** The navigation type of the waypoint as set in the mission editor.
- **Waypoint Latitude:** Stored as North or South degrees/minutes/tenths. Format is N/S xx°xx.xxx. Default is North.
- **Waypoint Longitude:** Stored as East or West degrees/minutes/tenths. Format is E/W xxx°xx.xxx. Default is East.
- **Waypoint MGRS:** Stored as Grid, Area, Eastings and Northings. Format is: ##N XX YYYYYZZZZZ.
- **Waypoint Elevation:** Number range from -1000 to +32767.
- **Waypoint DTOT:** Desired Time on Target, time stored as hours:minutes:seconds using a 24-hour clock. Format is HH:MM:SS; All zeroes indicate no DTOT entered.
- **Waypoint Datum:** This indicates the spheroid and grid data from which all coordinates are processed. WGS84 is always used.
- **Waypoint Steer Mode:** This can be set as: TO FROM, DIRECT, or TO TO. Set in mission editor.
- **Waypoint VNAV Mode:** This can be cycled between 2D and 3D vertical navigation modes. Set in mission editor.
- **Waypoint Scale:** This can be adjusted to display scale in accordance to ROUTE, APPROACH, HIGH ACC, or TERMINAL. Set in mission editor.

Auxiliary Avionics Panel (AAP)



Figure 133. Auxiliary Avionics Panel (AAP)

The AAP is located on the right console below the CDU and provides the power for both the CDU and EGI Systems. It consists of two ON/OFF switches, two rotary knobs, and one cycle steerpoint switch.

1. **CDU Power Switch.** Labeled CDU, this two-position switch has two positions: ON enables power to the CDU and OFF disables power. Upon starting a mission, it is advised that you provide power to the CDU soon after engine start as it will take considerable time to align the navigation system.
2. **EGI Power Switch.** Labeled EGI, this two-position switch has two positions: ON enables power to the EGI systems and OFF disables power. Upon starting a mission, it is advised that you provide power to the EGI soon after engine start as it will take considerable time to align the navigation system.
3. **PAGE Select Dial.** This four position dial labeled PAGE enables you to determine the general type of information displayed on the CDU screen. Except for the OTHER selection, all other selection are "read only" / informational.
 - 3.1. **OTHER.** In order to use the function select keys (FSK) on the CDU, the OTHER selection must be chosen. From OTHER you will be able to add and modify data to the CDU and view additional information.
 - 3.2. **POSITION.** Displays the POSINFO CDU page. This will provide information about your current position.
 - 3.3. **STEER.** Displays the STRINFO page that will provide detailed information about your steerpoint.
 - 3.4. **WAYPT.** Displays the WP INFO page. From this page you can view basic information about your selected waypoint, steerpoint, and your anchor point.
4. **STEER PT Dial.** As discussed earlier, the waypoint database is divided into sections. It allows you to access mission points, markpoints and flight plan points separately. Located on the left side of the AAP and labeled STEER PT, the dial has three positions:
 - 4.1. **FLT PLAN.** Select flight plan to make all the waypoints in the active flight plan active. If selected, use of the Steerpoint toggle switch will cycle between flight plan waypoints. FLT PLAN must be selected to display the flight plan route on the Tactical Awareness Display (TAD).
 - 4.2. **MARK.** When Markpoint is selected, cycling through waypoints will only cycle through the markpoints that you created (A-Z). Note that Z is automatically created when a weapon is used.
 - 4.3. **MISSION.** Selecting Mission will allow you to access the entire mission waypoint database.

5. **STEER Toggle Switch.** Located in the bottom center of the panel, the Steerpoint toggle switch defaults to center but can be toggled both up and down. Doing so will cycle forward and back through the waypoints according to your STEER PT Dial selection. Each time you select a new waypoint, it becomes the steerpoint.

Control Display Unit (CDU) and Pages

The CDU is located on the right console above the AAP and provides the control and information interface between you and the EGI navigation system. It consists of a display window, eight Line Select Keys (LSK), six Function Select Keys (FSK), an alphanumeric keypad, and several rocker switches and buttons.

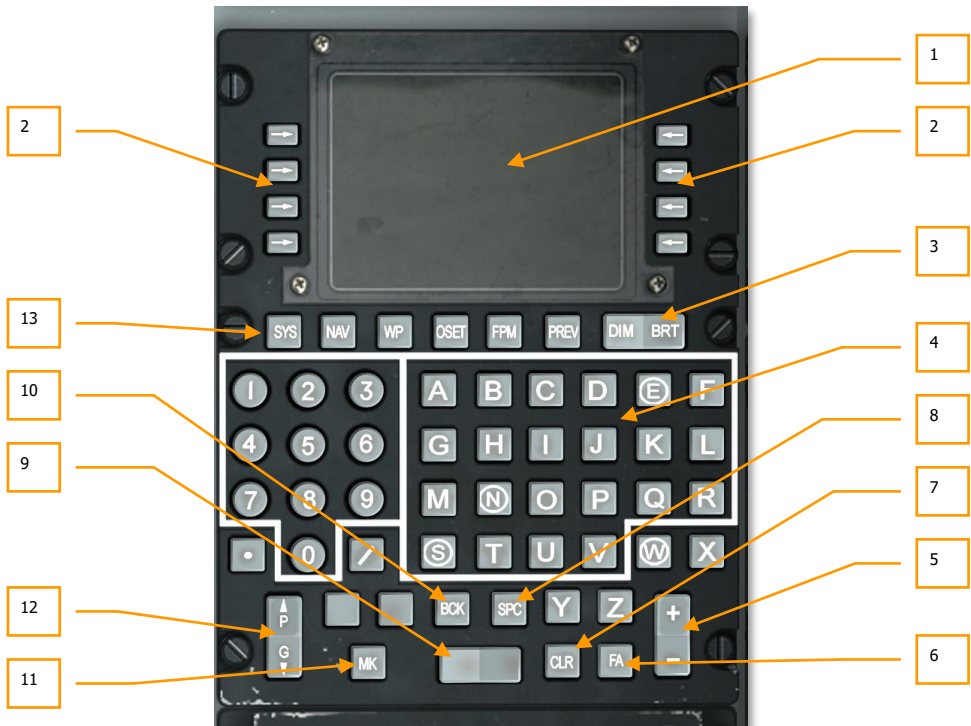

Figure 134. Control Display Unit (CDU)

1. **CDU Display Window.** The display screen is a 10-line visual display of 24 characters per line. Line 1 displays the page label, active flight plan and steerpoint, DTSAS and EGI mode, and Figure of Merit (FOM). Line 2 is used primarily for annunciations. Lines 3 through 9 are used with the Line Select Keys (LSK). A scratchpad, with up to 15 enterable characters, occupies the left side of the 10th line (L10).

Each of these fields is distinguished by a L/R and 1-10 character. It is this line definition that we will use throughout this chapter.

In addition to the CDU display window, CDU information may also be displayed on the MFCD CDU repeater page.



Figure 135. LSK Numbering System

2. **Line Select Keys (LSK).** Along the left and right sides of the display window are eight keys (four on each side of display). When depressed, they control data entry/selection on each page. Active line select keys are indicated by one of five symbols being displayed next to the line select key as described below:

← → **Branch.** Indicated as either a left or right pointing arrow. LSKs with this character direct you to a different CDU page when pressed.

± **Increment/Decrement.** When this symbol (plus and minus) is displayed, the ± rocker switch either steps through the data or enters data into the scratchpad using the keypad, and then entering the displayed data by depressing the line select key next to this symbol.

↑ **Rotary.** This type allows you to cycle through a series of values/settings in a preset order. Each press of the Rotary LSK will cycle to the next specified value.

[] Data Entry. This character type “[]” allows you to enter data from the CDU scratchpad and enter it into the system. This can include both alphanumeric and a string of numbers. If the data entered is valid, the scratchpad is cleared upon entry; if, however, the data is invalid, an error indication is placed on the scratchpad.

Ⓞ **System Action.** When this symbol is displayed, depressing the associated line select key initiates the indicated operation, function, or action.

CDU Keypad Keys

3. **DIM/BRT Rocker.** The DIM/BRT rocker provides dimming and brightness adjustment of CDU display window.
4. **Keyboards.** The keyboard pushbuttons include number/letter, decimal and front slash keys. Typed characters appear in the scratchpad and are then entered into the system via the Line Select Keys.
5. **± Rocker.** The ± rocker increments or decrements the displayed waypoint, markpoint, or data as indicated by the ± symbol next to a line select key (LSK).
6. **Fault Acknowledge (FA) Button.** The Fault Acknowledge pushbutton causes certain displayed fault or status annunciations to disappear and signals the system that the fault has been acknowledged.
7. **CLR Button.** The CLR pushbutton erases the entire scratchpad. Press this button to clear an error message on the CDU.
8. **SPC Button.** The SPC button provides capability for inserting space in a scratchpad data entry string.
9. **Blank Rocker.** The Blank rocker provides a means to step through and display in the scratchpad the identifiers in the CDU database on the ANCHOR, STRINFO, WAYPT, WP INFO, FPBUILD and OFFSET pages.
10. **BCK Button.** The BCK pushbutton erases the character to the left of the cursor in the scratchpad. Holding the pushbutton depressed will cause characters to disappear in a manner similar to repeated pressing of the pushbutton.
11. **MK Button.** The MK pushbutton commands creation of an overhead markpoint or overhead update.
12. **Page (P/G) Rocker Switch.** Some CDU pages have sub-pages (i.e., 1 of 2, 2 of 2, etc.). The Page rocker switch steps backward or forward between these pages.

13. **Function Select Keys (FSK).** Located beneath the CDU display window, the function select keys select the CDU page indicated when the AAP page select switch is in the OTHER position:
 - 13.1. **SYS:** Commands display of System (SYS) Page
 - 13.2. **NAV:** Commands display of Navigation (NAV) Page
 - 13.3. **WP:** Commands display of Waypoint Menu (WP MENU) Page
 - 13.4. **OSET:** Commands display of OFFSET Page
 - 13.5. **FPM:** Commands display of Flight Plan Menu (FPMENU) Page
 - 13.6. **PREV:** Return to previous page

Standard Line Display Items

On the first and second line of every CDU page are a set of common elements. These include:

On the first line:

- Flashing asterisk indicates DTS upload and download activity
- Page title
- Active flight plan field (blank if AAP STEER PT is not in FLT PLN)
- Current steerpoint number (left justified)
- DTSAS Figure of Merit (FOM). The Digital Terrain System Application Software (DTSAS) consists of a digital elevation database. DTSAS allows ground collision and obstacle warnings. The FOM value indicates how accurate the DTSAS data is.
- EGI Navigation solution mode and Figure of Merit (FOM)

On the second line: Line 2 is normally blank and reserved for CDU system annunciations. The following list shows messages you may receive:

- **STANDBY:** Displayed until CDU detects first valid initial position.
- **EGI NOT RDY:** Displayed whenever the EGI switch on the AAP is set to OFF. This message can be cleared by either placing the switch to ON or pressing the Fault Acknowledge (FA) key on the CDU.
- **DTC UPLOAD COMPLETE:** Data upload from DTS is complete. This occurs approximately 30 seconds after the IFFCC switch has been turned on (either TEST or ON). This marks the completion of data transfer from the data transfer cartridge.
- **HUD NOT RDY:** HUD not functioning, usually when the IFFCC switch on the AHCP has been placed in the OFF position. This message can be cleared by either placing the IFFCC switch to TEST or ON position, or by pressing the FA key on the CDU.

- **INS NAV RDY:** Steady annunciation indicates degraded EGI INS navigation capability is available. Flashing annunciation indicates full EGI INS navigation capability is available. It will only clear when NAV is selected on the ALIGN page indicating that the system is now operational.
- **MARK (A-Z):** Indicates a markpoint has been generated and stored. This message will display for 30 seconds, then automatically clear—or the user can push FA to clear.
- **CADC FAIL:** The Central Air Data Computer (CADC) is damaged and inoperative.
- **DTS FAIL:** Data Transfer System (DTS) is damaged and inoperative.
- **EGI FAIL:** The Embedded GPS INS (EGI) system is damaged and inoperative.
- **GPS FAIL:** Global Positioning System (GPS) navigation is damaged and inoperative.
- **HARS FAIL:** The Heading Attitude Reference System (HARS) is damaged and inoperative.
- **INS FAIL:** The Inertial Navigation System (INS) is damaged and inoperative.
- **INS FLT INST FAIL:** Flight instruments (ADI and HSI) being supplied data from the INS system are no longer being fed reliable data.
- **CADC NOT RDY:** The Central Air Data Computer (CADC) is not communicating with the communications bus.
- **DOWNLOAD COMPLETE:** Simulated data transfer from the data transfer cartridge is complete. This will appear each time new data is loaded from the DTS (DTSDNLD page).
- **DOWNLOAD FAILED:** Displayed when the transfer of data from the data transfer cartridge has failed or is incomplete. This will most often happen when the DTS is already in a Failed state.
- **IFFCC NOT READY:** Displayed when the IFFCC is not communicating over the communications bus. This most often happens when the IFFCC switch is set to OFF.
- **DTSAS OFF MAP:** Displayed when the current aircraft position is off the loaded digital map. Default map size is 150 km.
- **GPS KEY ERASED:** When a GPS key is erased, this message will be displayed.
- **GPS NEEDS KEYS:** This will happen when GPS key is zeroized and a key is needed.
- **WARM START:** Displayed when CDU has suffered 3-second or less power interruption.

Scratchpad. Displayed on the 10th line, this displays characters entered by you using the CDU keypad. The CDU scratchpad consists of 15 characters; the HUD scratchpad contains 24 characters.

Waypoint ID Search Function

The waypoint search function is used to quickly locate the identifier name of a desired waypoint and it is automatically available on the CDU pages listed below:

- STRINFO Page
- WP INFO Page
- WAYPT Page
- ANCHOR Page

- OFFSET Page
- FPBUILD Page

Entering an alphabetical character (A to Z) and then entering a letter (A to Z or 0 to 9) in the scratchpad automatically initiates a search of the waypoint database for waypoint(s) whose identifier name begins with these two characters.

The cursor is removed from the scratchpad while the search is in progress.

If there are no waypoint ID names found that start with those characters, the scratchpad displays the entered characters, and the cursor returns to the third (blank) position when the search through the waypoint ID database is complete.

If waypoint ID name(s) are found starting with those characters, the first applicable waypoint ID name (in alphanumeric order) is displayed in the scratchpad (with the cursor overlaying the third character). If this is the desired waypoint, it is selected by pressing the appropriate identifier LSK.

If the waypoint ID name displayed in the scratchpad is not the desired waypoint, there are two options available:

Enter a third character into scratchpad and perform another search, **or**

Use the "←/→" rocker to toggle alphanumerically in either direction through the waypoint ID database until the desired anchor point is found.

Initialization and Alignment

After applying power to the CDU and EGI, the CDU and EGI automatically begin their initialization and then alignment. During this initialization, EGI extracts data from the mission file for the mission plan created in the mission editor, and the EGI will automatically align to the aircraft's present position (waypoint 0). Upon startup, the CDU initially displays the CDU STARTUP BIT TEST Page. The ALIGN Page is then displayed after the successful completion of the CDU STARTUP BIT TEST.



Figure 136. CDU Startup BIT

Upon completion of alignment, you will need to select NAV from the Navigation / Align Sub-page.

POS INFO Page

The POS INFO page is displayed when the AAP Page Select Switch is in POSITION. This page displays information on current aircraft location and conditions. The only options available to modify are the temperature and airspeed fields.



Figure 137. Position Information Page

Present Position Latitude, L3. Displays present position latitude. If not aligned, this field will display 11 asterisks.

Present Position Longitude, L4. Displays present position longitude. If not aligned, this field displays 11 asterisks.

Present Position Grid and Spheroid, L6. Displays present position grid and WGS84 spheroid, where ## is the grid zone number and N is the grid zone letter. If not aligned, this field displays 7 asterisks.

Present Position Area, Eastings, Northings, L7. Displays present position area, eastings, and northings. A is column letter, B is row letter, XXXXX is easting value, and YYYYY is northing value. If not aligned, this field displays 14 asterisks.

Speed Line Select Key, R3. This rotary line select key allows you to step through and display indicated airspeed (IAS), true airspeed (TAS) or ground speed (GS). The default mode on startup is IAS. If not aligned, this field displays three asterisks for the speed. When the aircraft is stationary, IAS will indicate 50 KIAS, TAS will indicate 70 KTAS, and GS will indicate 0. Using the rotary LSK, you may manually select the displayed speed to be displayed as IAS, TAS or GS.

MACH Number, R4. This field displays the aircraft speed as a value of Mach. If not aligned, this field displays four asterisks. When the aircraft is stationary, MACH indicates between 0.09 and 0.1.

Magnetic Variation (MV), R5. MV for region.

G Level, R7. This field displays the G level experienced by you, from -9.9 to +9.9 Gs.

Outside Air Temperature (OAT) Line Select Key, R9. This rotary line select key allows selection of either OAT in °C (default) or °F.

GPS Altitude (G ALT), L9. This field displays the present altitude in feet.

Scratchpad, L10.

STEER INFO Page

The STEER INFO page is displayed when the AAP Page Select Switch is in STEER. The page displays current steerpoint information.



Figure 138. Steerpoint Information Page

Steerpoint Line Select Key, L3. Allows you to select the steerpoint database and number/letter in one of three ways:

When the AAP STEER PT switch is set to MISSION and a numeric string (from 0 to 2050) is entered into scratchpad, then a specific MSN or NAV waypoint is assumed. Pressing the Steerpoint LSK selects that waypoint.

When the AAP STEER PT switch is set to MARK and a single alpha character is entered into scratchpad, then a specific markpoint is assumed. Pressing the Steerpoint LSK selects that markpoint.

The ± rocker switch on the CDU can be used to change the number/letter within the displayed waypoint database without using the LSK.

Steerpoint Identifier Entry Line Select Key, R3. When AAP STEER PT switch is set to MISSION or MARK, allows entry from scratchpad of steerpoint identifier, up to 12 letter characters.

Desired Magnetic Heading (DMH), L4. Displays wind corrected magnetic heading to steerpoint in degrees.

Distance (DIS) to Steerpoint, L5. Displays distance to steerpoint in nautical miles. When the distance is less than 100 miles, tenths of a nautical mile are displayed. When the distance is equal to or greater than 100 nautical miles, only whole nautical miles are displayed which are rounded off to the nearest nautical mile.

Elevation (EL) of Steerpoint, L6. Displays elevation of steerpoint. If no elevation present, displays 5 asterisks for elevation.

Bearing/Radial Rotary, Line Select Key, L7. Allows selection of bearing (BRG) (default) to steerpoint or radial (RAD) from steerpoint for display.

WAYPOINT Branch Line Select Key, L9. Allows you to go to WAYPT Page P1/2. When the WAYPT Page is selected from this page, the WAYPT Page will display the information for the current steerpoint.

Time to Go (TTG), R5. Displays time to steerpoint at current ground speed (shown in hours, minutes, and seconds). When ground speed is less than 3 knots, TTG will display 8 asterisks.

Time on Target (TOT), R6. Displays time of arrival at steerpoint at current ground speed in hours, minutes, and seconds (in selected time mode, GMT or local). When ground speed is less than 3 knots, TOT will display 8 asterisks.

Required Speed Rotary Line Select Key, R7. This line select key is only active (up and down arrow display) when a desired time on target (DTOT) has been uploaded or entered on the WAYPT Pages or a desired time to go (DTTG) has been entered using WAYPT Page 2/2. This line select key, when active, allows you to select either the required indicated airspeed (RIAS), required true airspeed (RTAS) or required ground speed (RGS) in knots. This field indicates the selected speed required to arrive at the steerpoint at the desired time. When a DTOT or DTTG has not been assigned, this field will be blank.

Speed Rotary Line Select Key, R9. This rotary line select key allows you to step through and display indicated airspeed (IAS), true airspeed (TAS) or ground speed (GS). This field indicates the selected speed in knots. The default mode on startup is IAS. If not aligned, this field will display 3 asterisks for the speed. When the aircraft is stationary, IAS will indicate 50 KIAS, TAS will display 70 KTAS and GS will indicate 0.

Wind (WND) Direction/Speed, R8. Displays current wind direction in degrees (magnetic) and speed in knots.

Scratchpad, L10.

WP INFO Page

The WP INFO page is displayed when the AAP Page Select Switch is in WAYPT. The page displays bearing, distance and time-to-go information for three different points: selected waypoint, steerpoint, and anchor point.



Figure 139. Waypoint Information Page

Waypoint Line Select Key, L3. Allows you to select a mission or navigation waypoint, or a markpoint for display as follows:

If a number from 0 to 2050 is entered in the scratchpad (a mission or navigation waypoint is assumed) and then this line select key pressed, the waypoint with the number displayed in the scratchpad becomes the displayed waypoint.

If an alphabetical character is entered in the scratchpad (a markpoint is assumed) and then this line select key is pressed, the markpoint with the alphabetical character displayed in the scratchpad becomes the displayed waypoint.

Waypoint Identifier Line Select Key, R3. Allows you to select a waypoint by using the scratchpad (waypoint ID database search procedure) and then pressing this line select key.

Time to Go to Waypoint, R4. Displays time to go to selected waypoint at current ground speed (shown in hours, minutes, and seconds). When ground speed is less than 3 knots, this field will display 8 asterisks.

Magnetic Heading/Distance to Selected Waypoint, R5. Displays magnetic heading in degrees and distance in nautical miles to selected waypoint. When the distance is less than 100 miles, tenths of a nautical mile are displayed. When the distance is equal to or greater than 100 miles, only whole nautical miles are displayed which are rounded off to the nearest nautical mile. When the distance exceeds 9998.5 nautical miles, the distance field will display "9999."

WAYPT Page Branch Line Select Key, L5. Allows you to go to WAYPT Page P1/2. When the WAYPT Page is selected from this page, the WAYPT Page displays the information for the last waypoint that was displayed.

Time to Go to Steerpoint, L8. Displays time to go to steerpoint at current ground speed, shown in hours, minutes, and seconds. When ground speed is less than 3 knots, this field will display 8 asterisks.

Magnetic Heading/Distance to Steerpoint, L9. Displays magnetic heading in degrees and distance in nautical miles to steerpoint. When the distance is less than 100 nautical miles, tenths of a nautical mile are displayed. When the distance is equal to or greater than 100 nautical miles, only whole nautical miles are displayed which are rounded off to the nearest nautical mile. When the distance exceeds 9998.5 nautical miles, the distance field will display "9999."

ANCHOR Page (ANCHOR PT) Branch Line Select Key, R7. Allows you to go to ANCHOR Page.

Time to Go to Anchor Point, R8. Displays time to go to anchor point at current ground speed, shown in hours, minutes, and seconds. When ground speed is less than 3 knots, this field will display 8 asterisks. When an anchor has not been selected using the ANCHOR Page, this field will display 8 asterisks.

Magnetic Heading/Distance to Anchor Point, R9. Displays magnetic heading in degrees (1 to 360) and ground distance in nautical miles (0 to 9999) to or from the anchor point as selected by the to (TO)/from (FR) anchor point line select key. When the distance is less than 100 nautical miles, tenths of a nautical mile are displayed. When the distance is equal to or greater than 100 nautical miles, only whole nautical miles are displayed which are rounded off to the nearest nautical mile. When an anchor has not been selected using the ANCHOR Page, this field will display 8 asterisks. When the distance exceeds 9998.5 nautical miles, the distance field will display "9999."

Anchor Point to (TO)/from (FR) Rotary Line Select Key, R9. Allows you to toggle between a display of magnetic heading/distance to (TO) or from (FR) the anchor point. FR is the default.

Scratchpad, L10.

SYS Page

The System (SYS) page is displayed when the AAP Page Select switch is in OTHER and the SYS FSK is depressed. If the SYS page is selected after completion of the CDU start up Built In Test (BIT), the SYS page initialization data will be displayed. This page and its sub-pages are used to check status of the GPS and INS navigation systems as well as related systems such as the CADC, CDU, HARS, LASTE and other related navigation-input systems. When in the SYS page, you can branch to the following sub-pages:

- EGI
- INS

- GPS
- REINIT
- LASTE
- HARS
- DTSAS
- RESET
- DTS
- LRUTEST
- OFPID
- CADC
- CDUTEST
- MXLOG



Figure 140. System (SYS) Page 1

SYS Page 1/2 Information

Page Number, R10. Displays current page number X and total number of pages in display Y. The PAGE rocker switch is used to scroll between all available pages.

EGI Page Branch Line Select Key, L3. Allows the selection and display of the EGI sub-page.

INS Page Branch Line Select Key, L5. Allows the selection and display of the INS sub-page.

GPS Page Branch Line Select Key, L7. Allows the selection and display of the GPS sub-page.

REINIT Page Line Select Key, L9. Allows the selection and display of the REINIT sub-page.

LASTE Page Branch Line Select Key, R3. Allows the selection and display of the LASTE sub-page.

HARS Page Branch Line Select Key, R5. Allows the selection and display of the HARS sub-page.

DTSAS Page Branch Line Select Key, R7. Allows the selection and display of the DTSAS sub-page.

RESET Page Branch Line Select Key, R9. Allows the selection and display of the RESET sub-page.

Scratchpad, L10

SYS Page 2/2 Information



Figure 141. System (SYS) Page 2

DTS Page Branch Line Select Key L3. Allows the selection and display of the DTS sub-page.

LRUTEST Page Branch Line Select Key, L5. Allows test of Line Replaceable Units (LRU).

Operational Flight Program (OFF) Identification Numbers (OFFID) Branch Line Select Key, L9. View current OFF versions loaded on aircraft.

CADC Page Branch Line Select Key, R3. View the fault check of the Central Air Data Computer (CADC).

CDUTEST Page Branch Line Select Key, R5. Test results of the CDU.

Maintenance Log (MXLOG) Branch Line Select Key, R9. View and erase maintenance log entries.

Scratchpad, L10

System / EGI Sub-Page

Page 1

The Embedded GPS INS (EGI) sub-page (four sub-pages embedded) is displayed when the EGI LSK is selected from the SYS page. This page indicates the operating mode of the embedded GPS INS navigation system. This page tells you if navigation data is being supplied by the INS or GPS systems, or the two combined. It also tells you the quality of data (Figure of Merit) and it displays EGI test results.



Figure 142. System / EGI Sub-Page 1

EGI INS Status, L3. Provides status of EGI INS. Possible status states can be:

- N: Not communicating
- I: Initializing
- V: Valid
- F: Failed
- T: Test

EGI GPS Status, Center 3. Provides status of EGI GPS.

- N: Not communicating
- I: Initializing
- V: Valid
- F: Failed
- T: Test

EGI Missionization Section (MSN) Status, R3. Provides status of EGI Missionization.

- N: Not communicating
- I: Initializing
- V: Valid
- F: Failed
- T: Test

If status of any of these three items comes back N or F, you can review the SYS/GPS or SYS/INS sub-pages to check the status of these navigation systems.

FLIGHT DRIVER Status, Center 5. Displays status of current flight driver. This can be either:

- BLENDED: Combination of INS and GPS navigation input.
- INS: Only INS navigation input.
- GPS: Only GPS navigation input.

This can be selected from the NAV page. You will generally set this to BLENDED unless either the INS or GPS systems become inoperative. If inoperative, you would want to select only the operating system (INS or GPS).

EGI INS Figure of Merit (FOM), L8. FOM indicates the quality performance of a device. In this case, it is used to indicate the accuracy of INS derived navigation data. This can range from 1 to 9 and represents accuracy of 26 m to 5,000 m. As such, the lower the FOM, the greater the accuracy of the INS derived data. An asterisk (*) symbol indicates that the FOM is unknown.

GPS Figure of Merit (FOM), Center 8. Identifies current EGI GPS figure of merit. This can range from 1 to 9 and represents accuracy of 26 m to 5,000 m. As such, the lower the FOM, the greater the accuracy of the GPS derived data. An asterisk (*) symbol indicates that the FOM is unknown.

EGI Blended (BLD) Figure of Merit (FOM). R8. Identifies current EGI BLENDED figure of merit. This can range from 1 to 9 and represents accuracy of 26 m to 5,000 m. As such, the lower the FOM, the greater the accuracy of the EGI derived data. An asterisk (*) symbol indicates that the FOM is unknown.

Page Number, R10. Page 1 of 4.

Scratchpad, L10.

Page 2

The second page of the SYS/EGI sub-page displays the status of several EGI Shop Replaceable Units (SRU) and Operational Flight Programs (OFF).



Figure 143. System / EGI Sub-Page 2

SPU Status, L3. Provides status of EGI system processor. Possible status states can be:

- N: Not communicating
- I: Initializing
- V: Valid
- F: Failed
- T: Test

GPS Status, R3. Provides status of EGI GPS receiver.

- N: Not communicating
- I: Initializing
- V: Valid
- F: Failed
- T: Test

ISA Status, L4. Provides status of EGI inertial sensor assembly.

- N: Not communicating
- I: Initializing
- V: Valid
- F: Failed
- T: Test

IE Status, R4. Provides status of EGI inertial electronics.

- N: Not communicating
- I: Initializing
- V: Valid
- F: Failed
- T: Test

PS Status, L5. Provides status of EGI power supply.

- N: Not communicating
- I: Initializing
- V: Valid
- F: Failed
- T: Test

MSN Status, R5. Provides status of EGI configurable avionics interface card.

- N: Not communicating
- I: Initializing
- V: Valid
- F: Failed
- T: Test

CHASSIS Status, L6. Provides status of EGI chassis.

- N: Not communicating
- I: Initializing
- V: Valid
- F: Failed
- T: Test

If status of any of these three items comes back N or F, you can review the SYS/GPS or SYS/INS sub-pages to check the status of these navigation systems.

EGI OFP ID, L7. Displays ID of loaded EGI OFP software.

EGI OFP Status, L8. Status of loaded EGI OFP software.

GEM OFP ID, L9. Displays ID of GPS receiver OFP.

Page Number, R10. Page 2 of 4.

Scratchpad, L10.**Page 3 and 4**

The third and fourth EGI pages are information only, and they display EGI BIT results. These are static and not functional in this simulation of the CDU.



Figure 144. System / EGI Sub-Page 3



Figure 145. System / EGI Sub-Page 4

System / INS Sub-Page

The INS page is displayed from the SYS page or when the TIME LSK is selected from either the NAV or GPS pages. From the INS sub-pages you can control and monitor the alignment of the INS navigation package, view current INS position, and update the INS. You will most often use these sub-pages when aligning the INS or to help diagnose an INS failure. Note that when you start the

EGI, the INS will automatically start its alignment. This page allows you to branch to other Inertial Navigation System sub-pages:

- ALIGN
- ALT ALIGN
- POS
- MISC
- INSSTAT
- UPDATE



Figure 146. System / INS Sub-Page

ALIGN Page Branch Line Select Key, L3. Allows the selection and display of the ALIGN page.

SYSTEM / INS / ALIGN



Figure 147. System / INS / ALIGN Sub-Page

This page has the following important functions:

Position Source (POS SOURCE), L4. This will indicate AUTO (DTC) because the loaded data from the DTC is being used to derive the alignment position.

Coordinate Format Select (L/L or UTM), L5. Press this LSK to display the initial aircraft position (INIT POSIT) in either Lat / Long or UTM coordinates.

Latitude / Grid and Spheroid of initial position, L7. Depending on the coordinate format, this will either display the latitude (L/L) of the initial position or the grid and spheroid (UTM).

Alignment Time and Status, L8. The left numeric displays the time that the INS has been in alignment mode and the right numeric displays the alignment status. Status indications include INIT (initialization mode), ATTD (attitude information available), ATTD+HDG (attitude and heading information available).

GROUND Alignment, R3. When first starting the aircraft and aligning it on the ground, GROUND will be selected by default. This results in a full gyrocompass alignment. The average ground alignment time is 5 minutes and is automatically started when the EGI switch is set to ON. The aircraft must not be moving for correct alignment.

INFLT (In Flight) Alignment, R5. If the INS alignment needs to be re-aligned while the aircraft is in flight or moving on the ground, this option is used. This alignment process uses current position and velocity measurements from the INS. Before starting an in-flight alignment, EGI, STR PT and ANCHR should be deselected from the Navigation Mode Select Panel or select HARS. The EGI GPS will then be used to align the EGI INS. This process can take between 5 and 10 minutes.

NAV (Navigation), R7. After alignment is complete, indicated by the flashing INS NAV RDY annunciation, you can press the NAV LSK to place the INS out of alignment mode and into navigation mode.

INS, R9. Press the INS LSK to return to the main INS page.

Scratchpad, L10. Scratchpad field.

SYSTEM / INS / ALT ALIGN

Alternate Align (ALTALGN) Page Branch Line Select Key, L5. Allows the selection and display of the ALTALGN Page. This page is the same as the ALIGN page but provides the ability to do a FAST alignment along with manual entry of magnetic heading. Ground and In-Flight alignment options are not available on this page. Use a FAST alignment when EGI GPS is not available, or a quick / less accurate alignment is needed.



Figure 148. System / INS / ALTALGN Sub-Page

This page has the following important functions:

Position Source (POS SOURCE), L4. This will indicate AUTO (DTC) because the loaded data from the DTC is being used to derive the alignment position.

Coordinate Format Select (L/L or UTM), L5. Press this LSK to display the initial aircraft position (INIT POSIT) in either Lat / Long or UTM coordinates.

Latitude / Grid and Spheroid of initial position, L7. Depending on the coordinate format, this will either display the latitude (L/L) of the initial position or the grid and spheroid (UTM).

Alignment Time and Status, L8. The left numeric displays the time that the INS has been in alignment mode and the right numeric displays the alignment status. Status indications include INIT (initialization mode), ATTD (attitude information available), ATTD+HDG (attitude and heading information available).

FAST Alignment, R3. This alignment mode is significantly degraded from a GROUND or INFLT alignment but requires much less time. A FAST alignment is based on stored heading data and Best Available True Heading (BATH). This mode would generally be used when EGI GPS data is not available or if a faster alignment that sacrifices accuracy is needed.

MH (Magnetic Heading), R5. This field displays the magnetic heading. If the data is not accurate, you can enter the MH in degrees (XX.X) in the scratchpad and then press the LSK to enter it.

NAV (Navigation), R7. After alignment is complete, indicated by the flashing INS NAV RDY annunciation, you can press the NAV LSK to place the INS out of alignment mode and into navigation mode.

INS, R9. Press the INS LSK to return to the main INS page.

Scratchpad, L10. Scratchpad field.

SYSTEM / INS / POSITION

Position (POS) Page Branch Line Select Key, R7. Allows the selection and display of the POS Page. The position page displays your current L/L and UTM coordinates as well as the projected cross track deviation. Elements of the page include:



Figure 149. System / INS / POS Sub-Page

L/L Coordinate, L3 and L4. These two lines list the latitude and longitude of the current position.

UTM Coordinate, L6 and L7. These two lines list the current UTM coordinate of the present position.

Cross Track Deviation, L8. Displays the cross-track deviation in miles left (L) or right (R) of the selected course line (as indicated on the HSI). This is pegged at 9.9 NM when in BLENDED or INS and 5.4 NM when in GPS.

GPS ALT, L9. This field displays the mean sea level (MSL) as calculated by EGI GPS.

Position Source, R3. Select how present position is determined using this LSK. Options include BLENDED, GPS, AND INS.

Scratchpad, L10. Scratchpad field.

SYSTEM / INS / INSSTAT

INS Status (INSSTAT) Page Branch Line Select Key, R3. Allows the selection and display of the INS status (INSSTAT) Page. This page shows the EGI INS display mode, status of INS data sent to various systems, and the selection of Attitude (ATT) mode.



Figure 150. System / INS / INSSTAT Sub-Page

EGI INS Display MODE, L3. This indicator shows the current display mode for EGI INS. Options include:

- OFF. EGI is powered off.
- STBY. EGI in standby mode.
- GC. Indicates gyrocompass (normal) alignment of EGI INS is being performed.
- AA. In-Flight alignment.
- SH. Stored heading alignment.
- NAV. Navigation mode.
- BATH. Best Available True Heading mode.
- ATT. Attitude mode.
- TEST. Built In Test (BIT) running.
- NARF. Navigation Alignment Refinement mode.

ATT (Attitude) mode, L5. Selecting ATT will disable EGI and HARS will be selected.

INS Systems Status, Center L4 to L9. Displays the status EGI INS data to the following systems:

- ADI ATT. ADI attitude data.
- HUD ATT. HUD attitude data.
- NAV. Navigation data.
- NAV RDY. Navigation data available.

- ALTITUDE. Altitude data.
- SENSORS. Sensor data.

The status for each of these can either be V (Valid) or F (Failed). NAV RDY can also indicate D (degraded navigation only).

Scratchpad, L10. Scratchpad field.

SYSTEM / INS / UPDATE

UPDATE Page Branch Line Select Key, R5. Allows the selection and display of the UPDATE Page. This page allows you to select a waypoint and provide an overhead INS update when flying over it. The basic procedure is to select a waypoint in the fly-to database, press the PROCEED LSK, overfly the waypoint's known location (such as a prominent landmark) and press the MK (markpoint) button on the CDU. You can then choose to accept or reject the INS update data.



Figure 151. System / INS / UPDATE Sub-Page

Update Waypoint, L3. This will be the waypoint to fly-over that you will base the INS update on. You can cycle the selected waypoint with the STEER switch on the AAP.

DIS (Distance) to Update Waypoint, L4. This line displays the distance (X.X) in NM to the selected update waypoint.

Update Waypoint Name, L5. The database name of the selected update waypoint is displayed here.

Time to Go (TTG) to reach Update Waypoint, L6. The estimated time to reach the entered update waypoint is displayed here.

Update Waypoint Coordinates, L7 and L9. Depending on the selected coordinate format selection, either the L/L or UTM coordinates of the selected update waypoint are displayed on these two lines.

Coordinate Format, R3. Press this LSK to cycle the coordinate format between L/L and UTM.

Magnetic Variation (MV), R5. Displays the magnetic variation of the update waypoint in degrees and tenths.

PROCEED, R7. When pressed, you can now press the MK button on the CDU to take the INS update. You will want to be over the selected update waypoint location when pressing MK.

Elevation (EL), R9. Elevation of selected update waypoint.

Scratchpad, L10. Scratchpad field.

Once the MK button has been pressed, the below screen is shown. From this screen you can confirm expected coordinates and elevation and decide to reject or accept the update.



Figure 152. System / INS / UPDATE AC / REJ Sub-Page

Coordinate Format, R3. Press this LSK to cycle the coordinate format between L/L and UTM.

ACCEPT INS update, L5. Press this LSK to accept the INS overhead update at this location.

REJECT INS update, R5. Press this LSK to reject the INS overhead update at this location.

Update Waypoint Coordinates, L7 and L9. Depending on the selected coordinate format selection, either the L/L or UTM coordinates of the selected update waypoint are displayed on these two lines.

North/South Position Error, L6. Provides the North/South position error in nautical miles and tenths.

East/West Position Error, R6. Provides the East/West position error in nautical miles and tenths.

Magnetic Heading (MHD) Error, R7 and Distance (DIS) Error, R8. Provides EGI INS position update error in magnetic heading in degrees and distance in nautical miles.

Elevation (EL), R9. Displays current steerpoint elevation.

Scratchpad, L10. Scratchpad field.

SYSTEM / GPS Sub-Page

The GPS page is displayed when the GPS LSK is selected from the SYS page. This page displays GPS navigation status and additional sub-page branches. You will most often use these sub-pages to monitor GPS tracking accuracy (FOM), Built In Test (BIT) results, and setting the GPS key.



Figure 153. System / GPS Sub-page

Initialization (INIT) Mode Action Line Select Key, L3. Allows the selection of GPS INIT mode. Asterisk indicates GPS is in INIT mode. You will see this when the EGI GPS system is first starting up or after being re-started mid-mission in case of failure.

Navigation (NAV) Mode Line Select Key, L5. Allows the selection of GPS NAV mode. Asterisk indicates GPS is in NAV mode. This is the normal operating mode of the EGI GPS after initialization has been completed.

GPS Figure of Merit (FOM), Center 3. Displays GPS figure of merit (FOM) number between 1 and 9. 1 equals less than 26 m and 9 equals greater than 5,000 m. The lower this value equates to greater GPS data accuracy.

Expected Horizontal Error (EHE), Center 4. Displays GPS expected horizontal error (EHE) in feet. This data is only valid when in NAV mode.

Expected Vertical Error (EVE), Center 5. Displays GPS expected vertical error (EVE) in feet. This data is only valid when in NAV mode.

Satellite Tracking States (STS), Center 6 and 7. Displays number of satellites (0 to 4) being used to calculate the navigation solution in state 5 (ST5) and in state 3 (ST3). The sum of the ST5 and ST3 fields are a number from 0 to 4. State 5 is preferable and provides the best GPS FOMs. When the EGI GPS is receiving both position and velocity information from a satellite, this satellite is

in state 5. When the EGI GPS is receiving only position information from a satellite, this satellite is in state 3. Usually state 3 occurs only briefly during initial satellite acquisition or during periods of jamming or noise.

GPSSTAT Page Branch Line Select Key, R3. Allows selection and display of GPS status (GPSSTAT) Page.

GPSBIT Page Branch Line Select Key, R5. Allows the selection and display of the GPSBIT Page. This line select key is inactive (no arrow displayed) if GPS BIT data is unavailable.

TIME Page Branch Line Select Key, R7. Allows the selection and display of the GPS time (TIME) Page.

GPSKEYS Page Branch Line Select Key, R9. Allows the selection and display of the GPS keys (GPSKEYS) Page.

Scratchpad, L10

SYSTEM / GPS STATUS / GPSSTAT Sub-Pages

This sub-page and its nested sub-page allow you to view the status of various EGI GPS systems. These two pages are information-only and provide you V (valid) / F (failed) or Y (yes) / N (no) indications. The following status elements on the two pages consist of the following:

Page 1



Figure 154. System / GPS / GPSSTAT Sub-Page 1

Navigation Data (NAV DATA) status, L4. This indicates the status of the GPS navigation data and can be either V (valid) or F (failed).

BIT In Progress (BIT INPR) status, L5. This indicates the status of the GPS BIT progress. This can be either N (not in progress) or Y (in progress).

Initialization Required (INIT REQ) status, L6. If the GPS requires time, position, or almanacs, this will indicate either N (initialization not required) or Y (initialization required).

GPS Time (UTC) status, L7. This indicates the status of the GPS time and can be either V (UTC time is valid) or F (UTC time is not valid).

Almanac Required (ALM REQ) status, L8. If the data almanac is required, this will indicate Y (almanac required). If not, it will indicate N (almanac not required).

FILTER status, L9. Indicates the type of Kalman filter being used for the GPS filter. This field can return either INS (inertial navigation system mode) or PVA (position velocity acceleration mode).

GPS status, R3. This indicates the global status of the GPS and can have the following indications:

- N (not communicating)
- V (valid)
- F (failed)
- I (initializing)
- T (test)

KEY USED status, R5. This indicates the status of the current GPS key. Possible key status can be:

- N (no key in use)
- U (key is unverified)
- I (incorrect key)
- V (verified key)

GUK USER status, R6. Identifies the status of the yearly key and can be either Y (yearly key in use) or N (yearly key is not in use).

Key Parity (KEY PAR) status, R7. The parity status of the loaded key can either be V (valid) or F (invalid).

KEY 2HR status, R8. This line indicates if the loaded key will be valid for the next two hours. This result can either be V (valid for next two hours) or F (will expire in next two hours).

GPS page return, R9. Pressing this LSK will return you to the main GPS page.

Scratchpad, L10. Scratchpad field.

Page 2



Figure 155. System / GPS / GPSSTAT Sub-Page 2

BATTERY status, L3. This indicates the status of the GPS receiver battery and can be either V (working) or F (failed).

Four Satellites (4 SAT) status, L4. This indicates if four or more GPS satellites are being tracked for optimal navigation. This can be either V (at least four satellites being tracked) or F (fewer than four satellites being tracked).

Receiver Processing Unit (RPU) status, L5. This indicates the status of the EGI GPS processing unit. It can either be V (working) or N (failed).

Mission Duration (MSN DUR) status, L7. The number left of the slash indicates the number of days the GPS key will be valid for and the number to the right of the slash indicates the number of days remaining that the GPS key will be valid for.

Sufficient Keys (SUFKEYS) status, R3. If the loaded key will be valid for the duration of the mission, this field will indicate Y. If not, it will indicate N. If the key has not been defined, this field will indicate U.

ERASEFAIL status, R4. If the last key erase completed successfully, Y will be indicated. If unsuccessful, it will indicate N.

HAS KEYS status, R5. If the EGI has been loaded with a key, this line will indicate Y. If not, it will indicate N.

KEYLOAD FAILED status, L8. After a GPS key has been loaded, you can check this line to see if it was loaded successfully. YES indicates it was not loaded and NO indicates it was loaded.

Scratchpad, L10. Scratchpad field.

SYSTEM / GPS STATUS / GPSBIT Sub-Pages

This sub-page and its nested sub-page allow you to view the Built In Test (BIT) results of the GPS systems and any code word failures. These five pages are information-only. The BIT result elements on these pages consist of the following:

Page 1:



Figure 156. System / GPS / GPSBIT Sub-Page 1

KYK status, L3. This indicates the status of the EGI GPS key circuitry. BIT result can either be P (pass) or F (fail).

LRU status, R3. Indication of the Line Replaceable Unit (LRU) EGI GPS circuitry. BIT result can either be P (pass) or F (fail).

DPRAM status (STAT) WORD 1, L4. This field displays the status word of the memory shared by the EGI and EGI GPS circuitry.

DPRAM status (STAT) WORD 2, L5. This field displays the status word of the memory shared by the EGI and EGI GPS circuitry.

Battery Voltage (BATT VLT) UNLOADED, L6. Displays the EGI GPS battery voltage when unloaded.

Battery Voltage (BATT VLT) LOADED, L7. Displays the EGI GPS battery voltage when loaded.

GEM CHECKSUM, L8. OFP checksum of the EGI GEM.

GPS, R9. Return to the main GPS page.

Scratchpad, L10. Scratchpad field.

Page 2:



Figure 157. System / GPS / GPSBIT Sub-Page 2

Page 2 of the GPSBIT sub-pages displays the EGI GPS BIT fail indicator words. This is only used by ground crew.

GPS, R9. Return to the main GPS page.

Scratchpad, L10. Scratchpad field.

Page 3:



Figure 158. System / GPS / GPSBIT Sub-Page 3

The 3rd page displays EGI GPS BIT information words. This is only used by ground crew.

GPS, R9. Return to the main GPS page.

Scratchpad, L10. Scratchpad field.

Page 4:



Figure 159. System / GPS / GPSBIT Sub-Page 4

The 4th page displays EGI GPS failure identifiers and words and the ability to cycle between block failures. This is only used by ground crew.

GPS, R9. Return to the main GPS page.

Scratchpad, L10. Scratchpad field.

Page 5:



Figure 160. System / GPS / GPSBIT Sub-Page 5

The 5th page displays EGI GPS information identifiers and words and the ability to cycle between block failures. This is only used by ground crew.

GPS, R9. Return to the main GPS page.

Scratchpad, L10. Scratchpad field.

SYSTEM / GPS / GPSKEYS Sub-Page

The GPS Keys page allows you to turn on and off GPS signal encryption and set the duration that the GPS key will be valid for.



Figure 161. System / GPS / GPKEYS Sub-Page

ANTI-SPOOFING, L3. When set to ON, the EGI only uses encrypted military GPS signals when performing navigation.

Duration (DUR), L7. The number of days the key is valid for is left of the slash and the number of remaining days is indicated to the right.

ZEROIZE, L9. Press this LSK to erase the current key.

GPS, R9. Return to main GPS page.

Scratchpad, L10. Scratchpad field.

SYSTEM / GPS / TIME Sub-Page

The TIME sub-page allows you to set current date and time and adjust Desired Time on Target (DTOT) and adjust for local time.



Figure 162. System / TIME Sub-Page

Desired Time on Target (DTOT) ADJUST Entry Line Select Key, L3. This mission adjustment time is added to, or subtracted from, the DTOT for each waypoint that has a DTOT assigned. This causes the DTTG for each waypoint that has a DTOT assigned to be changed to reflect this mission adjustment time.

Local (LCL) ADJUST Line Select Key, L7. Allows local time adjustment (+1200 to -1200 hours) to be entered as HHMM where:

- HH = hours
- MM = minutes

YEAR Display, R3. Displays last two digits of the current GMT year (system date).

MONTH Display, R5. Displays two digits for the current GMT month (system date).

DAY Display, R7. Displays two digits of the current GMT day (system date).

GMT Time Display, R9. GMT or local time as HH:MM:SS depending on the following:

- If the LCL ADJUST field displays + or - 00:00, this field displays GMT time.
- If the LCL ADJUST field displays any value other than + or -00:00, this field displays local (LCL) time.

Scratchpad, L10

SYSTEM / Reinitialize (REINIT) Sub-Page

The REINIT sub-page allows you to reset the primary navigation and flight control systems in case of malfunction. Before reinitializing a system though, you can view its LRU status according to its code:

- N (not communicating)
- I (initializing)
- V (valid)
- F (failed)
- T (test)



Figure 163. System / REINIT Sub-Page

REINIT INS, L3. Reset the Inertial Navigation System (INS).

REINIT GPS, L5. Reset the Global Positioning System (GPS).

REINIT LASTE, L7. Reset the Low Altitude Safety and Targeting Enhancement (LASTE).

REINIT DTSAS, L9. Reset the Digital Terrain System Application Software (DTSAS).

From R3 to R8 are listed the status of the following systems:

- CADC
- HARS
- DTS
- CDU
- MBC
- MSN

Scratchpad, L10

SYSTEM / LASTE Sub-Page

The LASTE page is displayed when the LASTE LSK is selected from the SYS page. This page displays the status of the LASTE system and associated sub-systems that include its OFF, weapon release events and Ground Collision Avoidance System (GCAS). It also contains a sub-page for wind-data entry.



Figure 164. System / LASTE Sub-Page

READY Discrete, L3. Identifies if LASTE is ready: YES or NO.

LASTE Status, R3. Displays status of LASTE through the following codes:

- N = not communicating
- I = initializing

- V = valid

Operational Flight Program (OFP) load status, L5. Depending on the status of the LASTE, this can be: NOT ATTEMPTED, IN PROGRESS, SUCCESSFUL, or FAILED.

Initialization (INIT) load status, L6. This field displays the LASTE initialization status. This can be: NOT ATTEMPTED, IN PROGRESS, SUCCESSFUL, or FAILED.

SERVICE action last performed, L7. The last task that was performed will be listed in this field. These actions can include:

- NONE
- OFFSET MARK
- LASTE EVENT
- GCAS EVENT
- RDY FOR OFP
- RDY INIT
- PREP OFF UPDT
- HOT ELEVATION
- LOAD PASS
- LOAD FAIL
- HACK TIME

Weapons (WPN) EVENTS, L8. Total number of weapons events that have occurred and been transferred to the DTS.

Ground Collision Avoidance System Messages (GCAS MSGS), L9. Displays total number of GCAS (DTSAS and HUD) messages that have occurred and been transferred to the DTS.

WIND Page Branch Line Select Key, R9. Allows the selection and display of the WIND Page. Pages 1 and 2 of the Wind sub-page provide the ability to enter wind data for seven different MSL altitudes. Each of these altitudes can be assigned a unique wind direction, wind speed, and temperature.



Figure 165. System / LASTE / WIND Sub-Page

LSK 5, 7, and 9 on page 1 and LSK 3, 5, 7 and 9 on page 2. Press any of these LSK to enter wind data into the field. Prior to pressing the LSK, enter the desired altitude in thousands of feet MSL (00 to 99).

Current Wind and Air Temperature, R2. This data field displays the IFFCC calculated current wind direction / wind speed and air temperature.

Model Mode option, R3. This LSK allows you to select between BOTH, WIND, TEMP, and NONE. The selection will be used by the IFFCC to determine which data is used for ballistic calculations.

Wind Edit (WNEEDIT), R5. After one of the altitude fields has been selected (enter altitude in scratchpad and then press LSK), you will then press the WNEEDIT LSK to input the wind and temperature data. First enter the magnetic wind direction as three digits and then the wind speed in knots as two digits. Once the five digits are entered in the scratchpad, press the LSK again next to the selected altitude field. After wind direction and speed have been entered, enter air temperature in Celsius on the scratchpad and then press the TEMP LSK.

Clear (CLR) data, R7. To erase all the wind data, press the CLR LSK. Press it a second time after the CONFIRM message.

LASTE, R9. Return to the main LASTE page.

Scratchpad, L10

To summarize, you will perform the following steps to create an altitude field and set the data for it:

1. Enter altitude in thousands of feet (00 - 99) on the scratchpad and press an available altitude LSK.
2. Press the WNEEDIT LSK
3. Enter three-digit wind direction and two digit speed as a single five digit number string on the scratchpad and press the LSK left of the altitude you are editing.
4. Enter wind temperature for altitude in Celsius as two digits in scratchpad and then press WIND TEMP LSK.

SYSTEM / HARS Sub-Page

The Heading Attitude Reference System (HARS) can be monitored from this page for valid operation and data output.



Figure 166. System / HARS Sub-Page

INVALID status, L3. This field provides a YES or NO indication of the HARS providing valid data. If the data is invalid, this field will show YES, but if it is operating normally and providing valid data, it will show NO.

ROLL, L5. HARS roll in degrees and data validity code. V indicates valid data and F indicates failed.

PITCH, L7. HARS pitch in degrees and data validity code. V indicates valid data and F indicates failed.

MAG HEAD, L9. HARS heading in degrees and data validity code. V indicates valid data and F indicates failed.

Scratchpad, L10

SYSTEM / DTSAS Sub-Page

The Digital Terrain System Application Software (DTSAS) page is displayed when the DTSAS LSK is selected from the SYS page. This page allows you to view and configure the digital elevation navigation support. Most importantly, you can select between DTSAS or Coordinate Ranging (CR) modes from this page.



Figure 167. System / DTSAS Sub-Page

DTSAS Function Action Line Select Key, L3. Allows the DTSAS function to be enabled/disabled. Pressing this line select key alternately toggles the DTSAS function between ON and OFF. When this field indicates OFF, the DTSAS function is disabled.

Coordinate Ranging (CR) Sub-function Action Line Select Key, L5. Enables or disables the coordinate ranging sub-function of DTSAS. You would only use CR to find the elevation of a coordinate that is entered on the CDU waypoint page.

Horizontal Position Uncertainty (HPU), L7. Displays DTSAS calculated HPU (0 to 3346 feet). If DTSAS is OFF or failed, this field will display three asterisks.

Vertical Position Uncertainty (VPU), L8. Displays DTSAS calculated VPU (0 to 207 feet). If DTSAS is OFF or failed, this field will display asterisks.

Predictive GCAS (PGCAS) Sub-function Status, R3. Indicates validity of PGCAS sub-function. This can have a status of either V (valid) or F (failed).

Obstacle Warning Cue (OWC) Sub-function Status, R4. Indicates validity of OWC sub-function. This can have a status of either V (valid) or F (failed).

Passive Ranging (PR) Sub-function Status, R5. Indicates validity of PR sub-function. This can have a status of either V (valid) or F (failed).

Look Aside Ranging (LAR) Sub-function Status, R6. Indicates validity of LAR sub-function. This can have a status of either V (valid) or F (failed).

Obstacle Warning Cue (OWC) Avoidance Height Entry Line Select Key, R8. Allows Obstacle Warning Caution (OWC) avoidance height (0 to 9999 feet) to be entered by entering desired height in scratchpad and then pressing this line select key. To change this value, enter a new value on the scratchpad and then press the LSK.

Scratchpad, L10

SYSTEM / RESET Sub-Page

If a fault is discovered with one of the following systems (indicated by an N or F status indication), you may wish to reset the system. Systems that can be reset from this page include:

- EGI
- LASTE
- CICU
- CADC
- HARS
- DTS

Each of these systems will have one of the following status indications:

- N (not communication)
- I (initializing)
- V (valid)
- F (failed)
- T (test)



Figure 168. System / RESET Sub-Page

EGI reset, L3. Reset Embedded GPS INS.

LASTE reset, L5. Reset Low Altitude Safety and Targeting Enhancement (LASTE).

CICU reset, L7. Reset Central Interface Control Unit (CICU).

CADC reset, R3. Reset the Central Air Data Computer (CADC).

HARS reset, R5. Reset the Heading Attitude Reference System (HARS).

DTS reset, R7. Reset the Data Transfer System (DTS).

Scratchpad, L10

SYSTEM / DTS Sub-Page

The Data Transfer System (DTS) page and its nested pages provide you the status of the DTS systems and the means to monitor DTS data uploading and downloading. Most often this will be done through the DTS MFCD page, but if you encounter problems, you can use these pages to help diagnose the problem.



Figure 169. System / DTS Sub-Page

DTS status, L3. This field displays the status of the DTS according to the following codes:

- N (not communicating)
- I (initializing)
- V (valid)
- F (failed)

DTS ready status, L5. If the DTS can read the data, this field will indicate YES. If unable, it will indicate NO.

DTSUPLD branch, R3. Press this LSK to view the DTS Upload page.

DTSDNLD branch, R5. Press this LSK to view the DTS Download page.

DTSSTAT branch, R7. Press this LSK to view the DTS Status page.

Scratchpad, L10

SYSTEM / DTS Upload (DTSUPLD) Page

To upload data from a mission to the DTS, you can use this page. There are three selections, and once you select one, an asterisk will flash next to the DTSUPLD page title until the upload is complete. Once complete, a DTC UPLOAD COMPLETE annunciation will appear.



Figure 170. System / DTS Upload Sub-Page

Upload All Original Data (ALL ORIG DATA), L3. Upload all original waypoints, flight plans, CDU preferences, and LASTE settings.

Upload Original Navigation Data (ORIG NAV DATA), L5. Upload all original navigation data.

Upload Recent Navigation Data (RECENT NAV DATA), L9. Upload only recent, original navigation data.

Upload CDU and LASTE Preferences (CDU/LASTE PREFERENCES), R3. Upload user-created CDU and LASTE setting preferences.

DTS, R9. Press this LSK to return to the main DTS page.

Scratchpad, L10

SYSTEM / DTS Download (DTSDNLD) Page

The DTS Download page allows you to specify three primary sources of data from the DTS to download. Once you select one, an asterisk will flash next to the DTSDNLD page title until the upload is complete. Once complete, a DTC DOWNLOAD COMPLETE annunciation will appear.



Figure 171. System / DTS Download Sub-Page

Download All Data (ALL), L3. Download all original waypoints, flight plans, CDU preferences, and LASTE settings.

Download GPS ALMANAC, L5. Download entire GPS constellation almanac.

Download LRU BIT LOG, L7. Download the Built In Test (BIT) log for all Line Replaceable Units (LRU).

DTS, R9. Press this LSK to return to the main DTS page.

Scratchpad, L10

SYSTEM / DTS Status (DTSSTAT) Page



Figure 172. System / DTS Status Sub-Page

Data Transfer Cartridge Identifier (DTCID), L3. Unique tracking code of the cartridge being used.

Version Number (VRSN) of DTS software, L4. OFP software version of the DTS being used.

DTS MODE, L5. Indicates the mode that the DTS is operating in. This can either be INDX during normal operations or N if there is a fault.

SELF TEST STATUS, L6 and L7. Three groups of four self test words.

BIT TEST, L8 and L9. Two groups of four self test words.

DTS status, R4. The operational status of the DTS is indicated as one of the following codes:

- V (valid)
- F (failed)
- N (not communicating)
- I (initializing)

DTS, R9. Press this LSK to return to the main DTS page.

Scratchpad, L10

SYSTEM / LRU Test (LRUTEST) Sub-Page

The LRU Test page allows you to run tests on several of the primary Line Replaceable Units (LRU). These include the CAD, CDU and DTS. If you encounter a problem with one of these LRU systems, you may wish to run an LRU test.



Figure 173. System / LRU Test Sub-Page

EGI TEST branch, L3. Press this LSK to view the EGI Test page.



Figure 174. System / INS / EGITEST Sub-Page

Global Positioning System (GPS) test, L3. Press this LSK to run a test of the EGI GPS LRU. This field can have one of three indications: UN (untested), IP (test in progress), or GO (passed test).

Inertial Navigation System (INS) test, L5. Press this LSK to run a test of the EGI INS LRU. This field can have one of three indications: UN (untested), IP (test in progress), or GO (passed test).

EGI Missionization (MSN) test, L7. Press this LSK to run a test of the EGI MSN LRU. This field can have one of three indications: UN (untested), IP (test in progress), or GO (passed test). To record the BIT results, you can press the RECORD LSK at R7.

STOP MSN, L9. To cease a test of the EGI MSN LRU, press this LSK.

LRUTEST, R9. Press to return to the LRU Test page.

Scratchpad, L10

Central Air Data Computer (CADC) test, L5. Press this LSK to run a test of the CADC LRU. This field can have one of three indications: UN (untested), IP (test in progress), or GO (passed test).

Control Display Unit (CDU) test, L7. Press this LSK to run a test of the CDU LRU. This field can have one of three indications: UN (untested), IP (test in progress), or GO (passed test). To test the CDU though, you must first press the TEST MODE LSK and confirm the selection.

Data Transfer System (DTS) test, R3. Press this LSK to run a test of the DTS LRU. This field can have one of three indications: UN (untested), IP (test in progress), or GO (passed test). To record the BIT results, you can press the RECORD LSK at R7.

TEST MODE, L9. To run a test of the CDU LRU, you must first press this LSK. Upon doing so, you will be prompted to select either Y (yes) or N (no). If you press Y on the CDU keypad, you can press LSK L7 to start the CDU LRU test. To end the test, press the EXIT TESTING LSK field. This will perform a WARM START of the CDU.

RECORD, R7. If the DTS LRU is being tested, you may press this LSK to record the BIT results.

Scratchpad, L10

SYSTEM / Operational Flight Profile Identification (OFPID) Sub-Page

The OFPID pages allow you to view the current OFPID software versions.



Figure 175. System / OFPID Sub-Page 1

CDU Setup OFP identification (CDU SU), L3 and L4. L4 lists the OFP startup identification number and checksum.

CDU OFP identification (CDU OFP), L5 and L6. L6 lists the OFP identification number and checksum.

DTS OFP identification (DTS), L7 and L8. L8 lists the OFP identification number and checksum.

Scratchpad, L10



Figure 176. System / OFPID Sub-Page 2

EGI OFP identification (EGI), L3 and L4. L4 lists the EGI OFP identification number and checksum.

EGI GEM OFP identification (EGI GEM), L5 and L6. L6 lists the EGI GEM OFP identification number and checksum.

DTSAS OFP identification (DTSAS), L7 and L8. L8 lists the DTSAS OFP identification number and checksum.

Scratchpad, L10

SYSTEM / Central Air Data Computer (CADC) Page

The CADC page allows you to view flight and flight environment data as being processed by the Central Air Data Computer.



Figure 177. System / CADC Sub-Page

FAULT status, L3. This will either indicate YES or NO depending on a fault being detected in the CADC system.

CADC status, R3. This displays the status of the CADC and can have one of the following status states:

- N (not communicating)
- V (valid)
- F (failed)
- T (test)

Pressure Altitude (P ALT), L4. This displays the current aircraft altitude in feet according to pressure and can either have a V (valid) or F (failed) status indication.

Barometric Altitude (B ALT), L5. This displays the current aircraft altitude in feet according to barometric pressure and can either have a V (valid) or F (failed) status indication.

True Air Speed (TAS), L6. This displays the current aircraft true airspeed in knots and can either have a V (valid) or F (failed) status indication.

MACH, L7. This displays the current aircraft airspeed as a value of Mach and can either have a V (valid) or F (failed) status indication.

Indicated Air Speed (IAS), L8. This displays the current aircraft indicated airspeed and can either have a V (valid) or F (failed) status indication.

Air Temperature (TEMP), L9. This displays the outside air temperature (OAT) in degrees of Celsius and can either have a V (valid) or F (failed) status indication.

Scratchpad, L10

SYSTEM / CDU Test (CDUTEST) Sub-Page

The CDU Test sub-pages allow you to run status tests of the various CDU sub-systems. You would use this page to help diagnose any CDU failure indications.

Page 1



Figure 178. System / CDU Test Sub-Page 1

CDU keyboard panel (DKI) status, L3. Status of the CDU keyboard indication. This can either be P (pass) or F (failed).

CDU Random Access Memory (RAM) status, L4. Status of the CDU RAM. This can either be P (pass) or F (failed).

CDU programmable memory (EEPROM) status, L5. Status of the CDU EEPROM. This can either be P (pass) or F (failed).

CDU floating point processor (FPP) status, L6. Status of the CDU FPP. This can either be P (pass) or F (failed).

Heading Attitude Reference Systems Interface (HARS I/F) status, R3. Status of the HARS interface to the CDU. This can either be P (pass) or F (failed).

1553 bus Random Access Memory (1553 RAM), R4. Status of the CDU 1553 bus. This can either be P (pass) or F (failed).

START, R5. To test the status of the above items, you will press the START LSK. Upon pressing START, each of the items will be tested and its status result will be listed as either P (pass) or F (failed).

DATA PUMP, R7. This will normally be set to OFF and would only be used for maintenance tests.

LRUTEST page branch, R9. Press this LSK to branch to the LRUTEST page.

Bitball Control (BBCTL) page branch, L9. Press this LSK to branch to the Bitball control page. A Bitball alerts the ground crew of CDU failure.

Scratchpad, L10



Figure 179. System / CDUTEST / BBCTL Sub-Page

This page displays the first to fifth bitballs (CDU errors) in memory.

CLEAR, R7. Press this LSK to clear all bitballs.

CDUTEST, R9. Press this LSK to return to the main CDU Test page.

Scratchpad, L10

Page 2



Figure 180. System / CDU Test Sub-Page 2

DISPLAY TEST, L3. Display CDU test pattern.

CODE and NAME, L5 and L6. These two fields display the code and name of each key of the CDU keyboard when pressed.

NAV Page

The NAV page is displayed when the AAP Page Select Switch is in OTHER and the NAV FSK is depressed. This page allows you to set navigation parameters and branch to other navigation sub-pages. Contents of this page include:

- ALIGN
- TIME
- UPDATE
- DTSUPLOAD
- BLENDED
- ATTRIBUTES
- OPTIONS
- DIVERT



Figure 182. Navigation Page

ALIGN Page Branch Line Select Key, L3. Allows the selection and display of the ALIGN sub-page.

TIME Page Branch Line Select Key, L5. Allows the selection and display of the TIME sub-page.

UPDATE Page Branch Line Select Key, L7. Branch to position update sub-page.

DTSUPLOAD Page Line Select Key, L9. Branch to DTS upload sub-page.

Commanded Navigation Mode Rotary Line Select Key, R3. Rotary between Blended, GPS Only and INS Only modes of navigation

ATTRIBUTES Page Branch Line Select Key, R5. Branch to waypoint attributes page.

OPTIONS Page Branch Line Select Key, R7. Branch to navigation options sub-page.

DIVERT Page Branch Line Select Key, R9. Allows selection and display of DIVERT Display Page.

Scratchpad, L10

NAV / ALIGN Sub-Page



Figure 183. NAV / ALIGN Sub-Page

This page has the following important functions:

Position Source (POS SOURCE), L4. This will indicate AUTO(DTC) because the loaded data from the DTC is being used to derive the alignment position.

Coordinate Format Select (L/L or UTM), L5. Press this LSK to display the initial aircraft position (INIT POSIT) in either Lat / Long or UTM coordinates.

Latitude / Grid and Spheroid of initial position, L7. Depending on the coordinate format, this will either display the latitude (L/L) of the initial position or the grid and spheroid (UTM).

Alignment Time and Status, L8. The left numeric displays the time that the INS has been in alignment mode and the right numeric displays the alignment status. Status indications include INIT (initialization mode), ATTD (attitude information available), ATTD+HDG (attitude and heading information available).

GROUND Alignment, R3. When first starting the aircraft and aligning it on the ground, GROUND will be selected by default. This results in a full gyrocompass alignment. The average ground

alignment time is 5 minutes and is automatically started when the EGI switch is set to ON. The aircraft must not be moving for correct alignment.

In Flight (INFLT) Alignment, R5. If the INS needs to be re-aligned while the aircraft is in flight or moving on the ground, this option is used. This alignment process uses current position and velocity measurements from the INS. Before starting an in-flight alignment, EGI, STR PT and ANCHR should be deselected from the Navigation Mode Select Panel or HARS should be selected. The EGI GPS will then be used to align the EGI INS. This process can take between 5 and 10 minutes.

Navigation (NAV), R7. After alignment is complete, indicated by the flashing INS NAV RDY annunciation, you can press the NAV LSK to place the INS out of alignment mode and into navigation mode.

INS, R9. Press the INS LSK to return to the main INS page.

Scratchpad, L10. Scratchpad field.

NAV / TIME Sub-Page

The TIME sub-page allows you to set current date and time and adjust Desired Time on Target (DTOT) and adjust for local time.



Figure 184. NAV / TIME Sub-Page

Desired Time on Target (DTOT ADJUST) Entry Line Select Key, L3. Allows a mission adjustment time for the steerpoint to be entered as HHMMSS where:

- HH = hours
- MM = minutes
- SS = seconds

Local (LCL ADJUST) Line Select Key, L7. Allows local time adjustment (+1200 to -1200 hours) to be entered as HHMM where:

- HH = hours
- MM = minutes

YEAR Display, R3. Displays last two digits of the current GMT year (system date).

MONTH Display, R5. Displays two digits for the current GMT month (system date).

DAY Display, R7. Displays two digits of the current GMT day (system date).

GMT Time Display, R9. GMT or local time as HH:MM:SS depending on the following:

- If the LCL ADJUST field displays + or - 00:00, this field displays GMT time.
- If the LCL ADJUST field displays any value other than + or -00:00, this field displays local (LCL) time.

Scratchpad, L10

NAV / UPDATE SUB-PAGE

Allows the selection and display of the UPDATE Page. This page allows you to select a waypoint and provide an overhead INS update when flying over it. The basic procedure is to select a waypoint in the fly-to database, press the PROCEED LSK, overfly the waypoint's known location (such as a prominent landmark) and press the MK (markpoint) button on the CDU. You can then choose to accept or reject the INS update data.



Figure 185. NAV / UPDATE Sub-Page

Update Waypoint, L3. This will be the waypoint to fly-over that you will base the INS update on. You can cycle the selected waypoint with the STEER switch on the AAP.

Distance (DIS) to Update Waypoint, L4. This line displays the distance (X.X) in NM to the selected update waypoint.

Update Waypoint Name, L5. The database name of the selected update waypoint is displayed here.

Time to Go (TTG) to reach Update Waypoint, L6. The estimated time to reach the entered update waypoint is displayed here.

Update Waypoint Coordinates, L7 and L8. Depending on the selected coordinate format selection, either the L/L or UTM coordinates of the selected update waypoint are displayed on these two lines.

Coordinate Format, R3. Press this LSK to cycle the coordinate format between L/L and UTM.

Magnetic Variation (MV), R5. Displays the magnetic variation of the update waypoint in degrees and tenths.

PROCEED, R7. When pressed, you can now press the MK button on the CDU to take the INS update. You will want to be over the selected update waypoint location when pressing MK.

Elevation (EL), R9. Elevation of selected update waypoint.

Scratchpad, L10. Scratchpad field.

Once the MK button has been pressed, the below screen is shown. From this screen you can confirm expected coordinates and elevation and decide to reject or accept the update.



Figure 186. NAV / UPDATE / AC/REJ Sub-Page

Coordinate Format, R3. Press this LSK to cycle the coordinate format between L/L and UTM.

ACCEPT INS update, L5. Press this LSK to accept the INS overhead update at this location.

REJECT INS update, R5. Press this LSK to reject the INS overhead update at this location.

Update Waypoint Coordinates, L7 and L8. Depending on the selected coordinate format selection, either the L/L or UTM coordinates of the selected update waypoint are displayed on these two lines.

North/South Position Error, L6. Provides the North/South position error in nautical miles and tenths.

East/West Position Error, R6. Provides the East/West position error in nautical miles and tenths.

Magnetic Heading (MHD) Error, R7 and Distance (DIS) Error, R8. Provides EGI INS position update error in magnetic heading in degrees and distance in nautical miles.

Elevation (EL), R9. Displays current steerpoint elevation.

Scratchpad, L10. Scratchpad field.

NAV / DTS Upload (DTSUPLD) Page

To upload data from a mission to the DTS, you can use this page. There are three selections, and once you select one, an asterisk will flash next to the DTSUPLD page title until the upload is complete. Once complete, a DTC UPLOAD COMPLETE annunciation will appear.



Figure 187. NAV / DTS Upload Sub-Page

Upload All Original Data (ALL ORIG DATA), L3. Upload all original waypoints, flight plans, CDU preferences, and LASTE settings.

Upload Original Navigation Data (ORIG NAV DATA), L5. Upload all original navigation data.

Upload Recent Navigation Data (RECENT NAV DATA), L9. Upload only recent original navigation data.

Upload CDU and LASTE Preferences (CDU/LASTE PREFERENCES), R3. Upload user-created CDU and LASTE setting preferences.

DTS, R9. Press this LSK to return to the main DTS page.

Scratchpad, L10

NAV / Attributes Sub-Page

Each waypoint in the CDU database can be assigned unique attributes. By default, a waypoint's attributes are:

- Scale: Enroute
- Steer: TO FROM
- Vertical Navigation Mode: 2D

There are two classes of attributes: those for a specific waypoint and those for a specific flight plan:

- Waypoint Specific Attributes. These are used when the AAP STEER PT dial is set to MISSION or MARK. These can be uploaded from the DTS or entered from the Waypoint page (new or modified).
- Flight Plan Specific Attributes. These are used when the AAP STEER PT dial is set to MISSION or MARK. These can also be uploaded from the DTS or created/modified from the Waypoint Attributes (WPTATT) page.



Figure 188. NAV / ATTRIB Sub-Page

This page has the following important functions:

SCALE, L5 and L6. Use the Scale setting to determine the Course Deviation Indicator (CDI) and glide slope indicator sensitivity. The sensitivity is measured by the dots on the HSI and ADI.

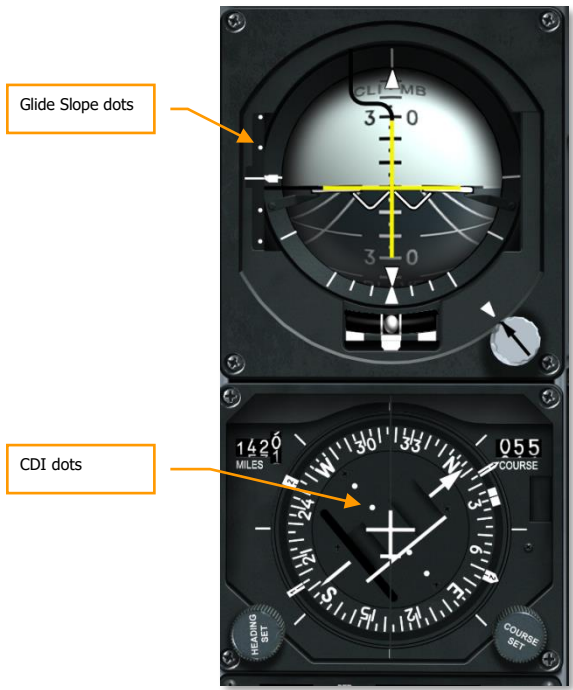

Scale options include:

- ENROUTE:
 - CDI Deviation Indication
 - 1 Dot = 2 nm
 - 2 Dots = 4 nm
 - Glide Slope Sensitivity
 - 1 Dot = 500 feet
 - 2 Dots = 1,000 feet
- TERMINAL:
 - CDI Deviation Indication
 - 1 Dot = 0.50 nm
 - 2 Dots = 1.0 nm
 - Glide Slope Sensitivity
 - 1 Dot = 250 feet
 - 2 Dots = 500 feet
- HIGH ACC:
 - CDI Deviation Indication
 - 1 Dot = 0.05 nm
 - 2 Dots = 0.10 nm
 - Glide Slope Sensitivity
 - 1 Dot = 100 feet
 - 2 Dots = 200 feet
- APPROACH:
 - CDI Deviation Indication
 - 1 Dot = 1.5°
 - 2 Dots = 3.0°
 - Glide Slope Sensitivity
 - 1 Dot = 0.35°
 - 2 Dots = 0.70°

STEER, L7 and L8. The CDU provides four steer modes: TO FROM, DIRECT, TO TO, and SCS. The TO FROM, DIRECT, and TO TO steer modes are waypoint and/or flight plan specific attributes. The steer attribute displayed on the Attributes (ATTRIB) Page or Waypoint (WAYPT) Page 2/2 is waypoint specific. The steer attribute displayed on the Waypoint Attributes (WPTATT) Page is flight plan specific. The SCS mode is not an attribute and can only be selected/deselected on the ATTRIB Page. The waypoint specific steer attribute is entered/changed using the ATTRIB Page or WAYPT Page 2/2. The flight plan specific steer attribute is entered/changed using the WPTATT Page.

Note:

- When ANCHR is selected, the SCS steer mode cannot be selected on the ATTRIB Page (SCS LSK is inactive).
- If the SCS steer mode has been selected and then ANCHR is selected on the NMSP, the SCS mode is automatically deselected, and steering cues are provided to the anchor point. These steering cues are determined by the attributes of the waypoint that is the anchor point.
 - **TO FROM** - the commanded course is the great circle path along the course entered via the HSI COURSE SET knob to/from the selected steerpoint.
 - **DIRECT** - the commanded course is the great circle path from the aircraft position at the time the DIRECT mode is selected to the selected steerpoint. Subsequently, each time a new steerpoint is selected, a course is computed from the aircraft's position at that instant to the new steerpoint.
 - **TO TO** - the commanded course is the great circle path from the designated From point, displayed on the CDU FROM Page, to the selected steerpoint.
 - **SCS** - the commanded course is manually selected course away from the point where the aircraft was located at the time SCS is selected.

Note:

- The TO FROM and SCS steer modes require that a selected course be entered using the COURSE SET knob on the HSI if you want consistent HSI course deviation indicator, ADI bank steering bar, and CDU Position (POS) Page cross track deviation (CROSS TRKDEV) indications.
- In the DIRECT and TO TO steer modes, the course arrow on the HSI should be set to the course indicated on the ATTRIB Page, using the COURSE SET knob on the HSI, for a consistent HSI course deviation indicator, ADI bank steering bar, and CDU POS Page cross track deviation (CROSS TRK DEV) indications.
- In the TO FROM, DIRECT, and TO TO modes, the TO steerpoint is shown in the upper right corner of the CDU as the waypoint (e.g., 1). In the SCS mode, this is replaced by SCS.
- When ANCHR is selected, the SCS steer mode cannot be selected on the ATTRIB Page (SCS LSK is inactive).

- If the SCS steer mode has been selected and then ANCHR is selected on the NMSP, the SCS mode is automatically deselected, and steering cues are provided to the anchor point. These steering cues are determined by the attributes of the waypoint that is the anchor point.
- The SCS steer mode is not an attribute and can only be selected or deselected on the ATTRIB Page.
- When the SCS steer mode is selected, SCALE and 2D or 3D can be selected to provide the desired steering cues.
- The CDU provides four scale modes: ENROUTE, TERMINAL, high accuracy (HIGH ACC), and APPROACH.

Selected Course Steering (SCS), L9. The EGI can provide navigation in both 2D and 3D modes and this in turn drives the HSI and ADI. Press this LSK to cycle SCS ON and OFF. When on, SCS appears on line 1 of the CDU display and indicates the navigation point.

Vertical Navigation Mode, R3. Press this LSK to cycle between 2D and 3D navigation. When in 3D navigation, vertical angle input may be selected.

3D Mode: When in 3D mode, a vertical angle can be automatically computed, or you can enter one manually. This will then drive the ADI steering indications in the vertical according to the VNAV setting.

2D Mode: Only horizontal heading data is passed to the HSI and ADI.



Figure 189. NAV / ATTRIB / VNAV Entry Sub-Page

Selected Vertical Angle, R5. Press this LSK to select between COMPUTED and ENTERED. When COMPUTED is selected, vertical steering will be automatically computed between the TO and FROM

points. When in ENTERED mode, use the scratchpad to enter the desired angle and then press the LSK to enter the value.

HSI data, R8 and R9. The HSI SET AT CRS field will display digitally the entered course steering on the HSI.

Scratchpad, L10. Scratchpad field.

NAV / OPTIONS Sub-Page

The Options sub-page allows you to view the current magnetic heading and magnetic variation.



Figure 190. NAV / OPTIONS/MAG Sub-page

MAG / GRID, L3. Press this LSK to cycle between magnetic heading and variation display and aircraft GRID data.

Magnetic Heading (MH), L4. Aircraft magnetic heading.

Magnetic Variation (MV), L5. When MAG is selected, you may enter a new MV as (E / W)(degree).(tenth of degree).

Scratchpad, L10



Figure 191. NAV / OPTIONS/GRID Sub-page

GRID Heading (GH), L4. Aircraft GRID heading.

Scratchpad, L10

NAV / DIVERT Sub-Page

The DIVERT page is displayed when the DIVERT LSK is selected on the NAV page. This page displays the waypoint number, waypoint identifier, magnetic heading and range, and time to go (TTG) for the 4 closest divert airfields. These divert airfields are listed in descending order, with the closest divert airfield (with respect to TTG at present speed) listed first. The information pertaining to these airfields is obtained from the navigation waypoint database.



Figure 192. NAV / DIVERT Sub-page

Divert Field Waypoint Number and Identifier Action Line Select Keys, L3, L5, L7 and L9. Displays waypoint number and identifier of the 4 closest diversion waypoints listed in descending

order with the closest airfield listed at the top. The line select keys allow selection of the diversion waypoint identified in the fields to the right of the pressed line select key as the steerpoint. Pressing this line select key, regardless of the selection of the AAP steer switch causes the selected diversion airfield to become the current steerpoint.

Once a diversion field has been selected as a steerpoint, changing the selection of the AAP steerpoint switch will deselect the diversion airfield as the steerpoint and set the appropriate point from the selected database (mission, mark, or flight plan) as the steerpoint.

If this Page is returned to (via the NAV Page) after a diversion airfield is selected, the target symbol to the right of the line select key of the selected diversion airfield will not be visible (line select key inactive). In addition, the steerpoint indicator (SP) will be visible to the right of the waypoint identifier of the selected diversion airfield.

Magnetic Heading/Range, L4, L6, L8 and L10. Displays magnetic heading (1 to 360 degrees) and range (0 to 999.9 NM) to the diversion waypoint identified in line above this field.

Time to Go (TTG), R4, R6, R8, R10. Displays TTG (hours:minutes:seconds) at current speed to the diversion airfield identified in line above this field.

Selected Steerpoint (SP) Indicator, L4, L6, L8 and L10. Indicates that the displayed diversion waypoint is the current selected steerpoint.

WP MENU Page

The WP MENU page is displayed when the AAP Page Select Switch is in OTHER and the WP FSK is depressed. From the sub-pages of this menu, you can view and set waypoint, steerpoint, anchor and the from point data. This page allows you branch access to the following sub-pages:

- STEERPOINT
- ANCHOR PT
- WAYPOINT
- FROM PT



Figure 193. Waypoint Menu Page

STEERPOINT Page Branch Line Select Key, L3. Allows the selection and display of the STEERPT sub-page for the steerpoint.

ANCHOR Page Branch Line Select Key, L5. Allows the selection and display of the ANCHOR PT sub-page.

WAYPOINT Branch Line Select Key, R3. Allows the selection and display of the WAYPT Page for the last waypoint displayed; the first actuation displays the first waypoint in the database (not 0).

FROM PT Page Branch Line Select Key, R5. Allows you to set the From Point navigation point.

Spheroid Data Entry Line Select Key, R9. Indication of the current spheroid being used for navigation.

Scratchpad, L10

WP / STEERPOINT Sub-Page

The WAYPOINT page is displayed when the steerpoint Page line select key is depressed within the WP MENU Page. This page provides you detailed information about the steerpoint, and it allows you to change it. From the second page you can set the attributes of the steerpoint.

Page 1



Figure 194. WP / STEERPOINT Sub-Page 1

FROM Point, R2. When TO TO is selected as the STEER mode, FROM and the waypoint acting as the navigation point to be navigated from is indicated. This FROM point can be edited in the FROM PT sub-page.

Steerpoint Line Select Key, L3. Allows you to select a mission or navigation waypoint or a markpoint for display as follows:

If a number from 0 to 2050 is entered in the scratchpad (a mission or navigation waypoint is assumed) and then this line select key pressed.

If an alphabetical character from A to Z is entered in the scratchpad (a markpoint is assumed) and then this line select key is pressed.

When the AAP STEER PT rotary select knob is set to MISSION or MARK, the operator can also use the \pm rocker switch on the CDU to select the waypoint within the displayed waypoint database without using the line select key.

If an invalid waypoint number or markpoint letter is entered, "CDU INPUT ERR" is displayed on the scratchpad and will remain until cleared by pushing the CLR Button.

Steerpoint Indicator, L3. When the waypoint displayed is also the current steerpoint, an "SP" will be displayed after the waypoint ID number.

Steerpoint Identifier Line Select Key, R3. Allows entry from scratchpad of steerpoint identifier, up to 12 alphanumeric characters. If two or more characters are entered (with the first an alpha character), a search through the waypoint ID database search is assumed as described in the Standard Line 10 Display previously. Once the desired waypoint identifier is in the scratchpad, pressing this LSK will display that waypoint information.

Pressing this LSK when a mission waypoint (0 through 50) or a markpoint (A through Z) is displayed and the identifier entered in the scratchpad is not present in the waypoint database will rename the displayed waypoint with the identifier displayed in the scratchpad.

If this line select key is pressed when a navigation waypoint (51 through 2050) is displayed and the entered waypoint identifier is not present in the waypoint ID database, "CDU INPUT ERR" is displayed on the scratchpad and will remain until cleared by pushing the CLR Button.

Waypoint Classification Indicator, R4. Indicates the waypoint type as defined in the Waypoint ID Database.

Elevation (EL) Entry Line Select Key, L5. Allows entry of elevation [in feet above mean sea level (MSL)] of mission waypoints from scratchpad. The range of elevation that can be entered is from -1000 feet to +32767 feet. Entering an elevation value and pressing the line select key enters a positive value. Pressing the line select key a second time changes the sign of elevation.

Coordinate Ranging (CR) Flag, L6. This field displays CR when CR is set to ON on the DTSAS Page, and the displayed mission waypoint elevation has been determined by DTSAS coordinate ranging. NO CR is displayed when:

CR is set to ON on the DTSAS Page and the elevation for the entered waypoint position (i.e., latitude and longitude) could not be determined by the DTSAS Coordinate Ranging function (e.g., off the digital map).

CR is set to OFF on the DTSAS Page. (The DTSAS option will remain permanently on).

This flag is only displayed when a mission waypoint position is modified. The flag is not displayed (i.e., blank) for navigation and markpoint waypoints.

Desired Time on Target (DTOT) Line Select Key, R5. Allows desired time of arrival at selected waypoint to be entered from scratchpad in hours, minutes, and seconds. The allowable DTOT entry range is from 1 to 240000. Leading zeroes do not have to be entered. When the DTOT is entered, the desired time to go (DTTG) is automatically updated to reflect the new DTOT. When a DTOT or DTTG has not been entered or assigned (uploaded from DTS) to the waypoint, this field and the DTOT and DTTG fields on Page 2/2 will display 8 asterisks.

Copy Action Line Select Key, R7. Allows waypoint data to be copied to the next available mission waypoint when line select key is pressed; the next available location is displayed next to the target symbol.

Wind (WND) Direction/Speed, R8. Displays current wind direction in degrees (magnetic) and speed in knots.

Alternate Coordinate Format Rotary Line Select Key, R9. Allows rotary selection of either "L/L" for Latitude Longitude format or "UTM" for Universal Transverse Mercator (UTM) coordinates. L/L is the default setting.

L/L Format:

L7. Waypoint Latitude Entry Line Select Key. Allows entry of waypoint latitude in degrees, minutes, and thousandths of a minute.

L9. Waypoint Longitude Entry Line Select Key. Allows entry of waypoint longitude in degrees, minutes, and thousandths of a minute.

UTM Format:

L7. Waypoint Grid and Spheroid Entry Line Select Key. Allows entry of waypoint UTM grid zone of up to two numeric characters and one alpha character, where ## is the grid zone number, and N is the grid zone letter. The Spheroid will always be WGS84.

L9. Waypoint Area, Eastings, Northings Entry Line Select Key. Allows entry of area in two alpha characters and eastings and northings in up to 10 digits. A is column letter, B is row letter, XXXXX is easting value, and YYYYY is northing value. This line select key is inactive (no brackets symbol displayed) for navigation waypoints (51 through 2050) and markpoints (A through Z).

Scratchpad, L10

Page 2



Figure 195. WP / STEERPOINT Sub-Page 2

Waypoint Number and Identifier, L2 and R2. Displays waypoint number and identifier of selected waypoint from Page 1.

SCALE, L3 and L4. Use the Scale setting to determine the Course Deviation Indicator (CDI) and glide slope indicator sensitivity. The sensitivity is measured by the dots on the HSI and ADI.

Scale options include:

- ENROUTE:
 - CDI Deviation Indication
 - 1 Dot = 2 nm
 - 2 Dots = 4 nm
 - Glide Slope Sensitivity
 - 1 Dot = 500 feet
 - 2 Dots = 1,000 feet
- TERMINAL:
 - CDI Deviation Indication
 - 1 Dot = 0.50 nm
 - 2 Dots = 1.0 nm
 - Glide Slope Sensitivity
 - 1 Dot = 250 feet
 - 2 Dots = 500 feet
- HIGH ACC:
 - CDI Deviation Indication
 - 1 Dot = 0.05 nm
 - 2 Dots = 0.10 nm
 - Glide Slope Sensitivity

- 1 Dot = 100 feet
- 2 Dots = 200 feet
- APPROACH:
 - CDI Deviation Indication
 - 1 Dot = 1.5°
 - 2 Dots = 3.0°
 - Glide Slope Sensitivity
 - 1 Dot = 0.35°
 - 2 Dots = 0.70°

STEER, L5 and L6. The CDU provides four steer modes: TO FROM, DIRECT, TO TO, and SCS. The TO FROM, DIRECT, and TO TO steer modes are waypoint and/or flight plan specific attributes. The steer attribute displayed on the Attributes (ATTRIB) Page or Waypoint (WAYPT) Page 2/2 is waypoint specific. The steer attribute displayed on the Waypoint Attributes (WPTATT) Page is flight plan specific. The SCS mode is not an attribute and can only be selected/deselected on the ATTRIB Page. The waypoint specific steer attribute is entered/changed using the ATTRIB Page or WAYPT Page 2/2. The flight plan specific steer attribute is entered/changed using the WPTATT Page.

Note:

- When ANCHR is selected, the SCS steer mode cannot be selected on the ATTRIB Page (SCS LSK is inactive).
- If the SCS steer mode has been selected and then ANCHR is selected on the NMSP, the SCS mode is automatically deselected, and steering cues are provided to the anchor point. These steering cues are determined by the attributes of the waypoint that is the anchor point.
 - **TO FROM** - the commanded course is the great circle path along the course entered via the HSI COURSE SET knob to/from the selected steerpoint.
 - **DIRECT** - the commanded course is the great circle path from the aircraft position at the time the DIRECT mode is selected to the selected steerpoint. Subsequently, each time a new steerpoint is selected, a course is computed from the aircraft's position at that instant to the new steerpoint.
 - **TO TO** - the commanded course is the great circle path from the designated From point, displayed on the CDU FROM Page, to the selected steerpoint.
 - **SCS** - the commanded course is manually selected course away from the point where the aircraft was located at the time SCS is selected.

Note:

- The TO FROM and SCS steer modes require that a selected course be entered using the COURSE SET knob on the HSI if you want consistent HSI course deviation indicator, ADI bank steering bar, and CDU Position (POS) Page cross track deviation (CROSS TRKDEV) indications.
- In the DIRECT and TO TO steer modes, the course arrow on the HSI should be set to the course indicated on the ATTRIB Page, using the COURSE SET knob on the HSI, for a consistent HSI course deviation indicator, ADI bank steering bar, and CDU POS Page cross track deviation (CROSS TRK DEV) indications.
- In the TO FROM, DIRECT, and TO TO modes, the TO steerpoint is shown in the upper right corner of the CDU as the waypoint (e.g., 1). In the SCS mode, this is replaced by SCS.
- When ANCHR is selected, the SCS steer mode cannot be selected on the ATTRIB Page (SCS LSK is inactive).
- If the SCS steer mode has been selected and then ANCHR is selected on the NMSP, the SCS mode is automatically deselected, and steering cues are provided to the anchor point. These steering cues are determined by the attributes of the waypoint that is the anchor point.
- The SCS steer mode is not an attribute and can only be selected or deselected on the ATTRIB Page.
- When the SCS steer mode is selected, SCALE and 2D or 3D can be selected to provide the desired steering cues.
- The CDU provides four scale modes: ENROUTE, TERMINAL, high accuracy (HIGH ACC), and APPROACH.

Vertical Navigation Mode, R5. Press this LSK to cycle between 2D and 3D navigation. When in 3D navigation, vertical angle input may be selected.

3D Mode: When in 3D mode, a vertical angle can be automatically computed, or you can enter one manually. This will then drive the ADI steering indications in the vertical according to the VNAV setting.

2D Mode: Only horizontal heading data is passed to the HSI and ADI.

Selected Vertical Angle, R4. Press this LSK to select between COMPUTED and ENTERED when in 3D vertical navigation mode. When COMPUTED is selected, vertical steering will be automatically

computed between the TO and FROM points. When in ENTERED mode, use the scratchpad to enter the desired angle and then press the LSK to enter the value.

Desired Time to Go (DTTG) Entry Line Select Key, L7. Allows desired time to go to selected waypoint to be entered from scratchpad in hours, minutes, and seconds (1 to 24000). When the DTTG is entered, the DTOT is automatically updated to reflect the new DTTG. Clearing DTTG (scratchpad empty and pressing this line select key) will cause both DTOT and DTTG fields to display 8 asterisks. When a DTOT or DTTG has not been entered or uploaded from DTS, this field and the DTOT field will display 8 asterisks.

Desired Time on Target (DTOT) Entry Line Select Key, L9. Allows desired time of arrival at selected waypoint to be entered from scratchpad in hours, minutes, and seconds (1 to 24000). When the DTOT is entered, the DTTG is automatically updated to reflect the new DTOT. Clearing DTOT (scratchpad empty and pressing this line select key) will cause both DTTG and DTOT fields to display 8 asterisks. When a DTOT or DTTG has not been entered or uploaded from DTS, this field and the DTTG field will display 8 asterisks.

Scratchpad, L10. Scratchpad field.

WAYPOINT Sub-Page

The WAYPOINT page is displayed when the WAYPOINT Page line select key is depressed within the WP MENU Page, STEER INFO Page or WP INFO Page. This page provides you detailed information about the currently selected waypoint. From the second page you can set the attributes of the waypoint.

Page 1:



Figure 196. WP / Waypoint Menu Sub-Page 1



Figure 197. Waypoint Menu Sub-Page using TO TO Steering

FROM Point, R2. When TO TO is selected as the STEER mode, FROM and the waypoint acting as the navigation point to be navigated from is indicated. This FROM point can be edited in the FROM PT sub-page.

Waypoint Line Select Key, L3. Allows you to select a mission or navigation waypoint or a markpoint for display as follows:

If a number from 0 to 2050 is entered in the scratchpad (a mission or navigation waypoint is assumed) and then this line select key is pressed.

If an alphabetical character from A to Z is entered in the scratchpad (a markpoint is assumed) and then this line select key is pressed.

When the AAP STEER PT rotary select knob is set to MISSION or MARK, the operator can also use the \pm rocker switch on the CDU to select the waypoint within the displayed waypoint database without using the line select key.

If an invalid waypoint number or markpoint letter is entered, "CDU INPUT ERR" is displayed on the scratchpad and will remain until cleared by pushing the CLR Button.

Steerpoint Indicator, L3. When the waypoint displayed is also the current steerpoint, an "SP" will be displayed after the waypoint ID number.

Waypoint Identifier Line Select Key, R3. Allows entry from scratchpad of steerpoint identifier, up to 12 alphanumeric characters. If two or more characters are entered (with the first an alpha character), a search through the waypoint ID database search is assumed as described in the

Standard Line 10 Display previously. Once the desired waypoint identifier is in the scratchpad, pressing this LSK will display that waypoint information.

Pressing this LSK when a mission waypoint (0 through 50) or a markpoint (A through Z) is displayed and the identifier entered in the scratchpad is not present in the waypoint database will rename the displayed waypoint with the identifier displayed in the scratchpad.

If this line select key is pressed when a navigation waypoint (51 through 2050) is displayed and the entered waypoint identifier is not present in the waypoint ID database, "CDU INPUT ERR" is displayed on the scratchpad and will remain until cleared by pushing the CLR Button.

Waypoint Classification Indicator, R4. Indicates the waypoint type as defined in the Waypoint ID Database.

Elevation (EL) Entry Line Select Key, L5. Allows entry of elevation [in feet above mean sea level (MSL)] of mission waypoints from scratchpad. The range of elevation that can be entered is from -1000 feet to +32767 feet. Entering an elevation value and pressing the line select key enters a positive value. Pressing the line select key a second time changes the sign of elevation.

Coordinate Ranging (CR) Flag, L6. This field displays CR when CR is set to ON on the DTSAS Page, and the displayed mission waypoint elevation has been determined by DTSAS coordinate ranging. NO CR is displayed when:

CR is set to ON on the DTSAS Page and the elevation for the entered waypoint position (i.e., latitude and longitude) could not be determined by the DTSAS Coordinate Ranging function (e.g., off the digital map).

CR is set to OFF on the DTSAS Page. (The DTSAS option will remain permanently on).

This flag is only displayed when a mission waypoint position is modified. The flag is not displayed (i.e., blank) for navigation and markpoint waypoints.

Desired Time on Target (DTOT) Line Select Key, R5. Allows desired time of arrival at selected waypoint to be entered from scratchpad in hours, minutes, and seconds. The allowable DTOT entry range is from 1 to 240000. Leading zeroes do not have to be entered. When the DTOT is entered, the desired time to go (DTTG) is automatically updated to reflect the new DTOT. When a DTOT or DTTG has not been entered or assigned (uploaded from DTS) to the waypoint, this field and the DTOT and DTTG fields on Page 2/2 will display 8 asterisks.

Copy Action Line Select Key, R7. Allows waypoint data to be copied to the next available mission waypoint when line select key is pressed; the next available location is displayed next to the target symbol.

Wind (WND) Direction/Speed, R8. Displays current wind direction in degrees (magnetic) and speed in knots.

Alternate Coordinate Format Rotary Line Select Key, R9. Allows rotary selection of either "L/L" for Latitude Longitude format or "UTM" for Universal Transverse Mercator (UTM) coordinates. L/L is the default setting.

L/L format:

L7. Waypoint Latitude Entry Line Select Key. Allows entry of waypoint latitude in degrees, minutes and thousandths of a minute.

L9. Waypoint Longitude Entry Line Select Key. Allows entry of waypoint longitude in degrees, minutes and thousandths of a minute.

UTM format:

L7. Waypoint Grid and Spheroid Entry Line Select Key. Allows entry of waypoint UTM grid zone of up to two numeric characters and one alpha character, where ## is the grid zone number and N is the grid zone letter. The Spheroid will always be WGS84.

L9. Waypoint Area, Eastings, Northings Entry Line Select Key. Allows entry of area in two alpha characters and eastings and northings in up to 10 digits. A is column letter, B is row letter, XXXXX is easting value, and YYYYY is northing value This line select key is inactive (no brackets symbol displayed) for navigation waypoints (51 through 2050) and markpoints (A through Z).

Page 2:



Figure 198. WP / Waypoint Menu Sub-Page 2

Waypoint Number and Identifier, L2 and R2. Displays waypoint number and identifier of selected waypoint from Page 1.

SCALE, L3 and L4. Use the Scale setting to determine the Course Deviation Indicator (CDI) and glide slope indicator sensitivity. The sensitivity is measured by the dots on the HSI and ADI.

Scale options include:

- ENROUTE:
 - CDI Deviation Indication
 - 1 Dot = 2 nm
 - 2 Dots = 4 nm
 - Glide Slope Sensitivity
 - 1 Dot = 500 feet
 - 2 Dots = 1,000 feet
- TERMINAL:
 - CDI Deviation Indication
 - 1 Dot = 0.50 nm
 - 2 Dots = 1.0 nm
 - Glide Slope Sensitivity
 - 1 Dot = 250 feet
 - 2 Dots = 500 feet
- HIGH ACC:
 - CDI Deviation Indication
 - 1 Dot = 0.05 nm
 - 2 Dots = 0.10 nm
 - Glide Slope Sensitivity

- 1 Dot = 100 feet
- 2 Dots = 200 feet
- APPROACH:
 - CDI Deviation Indication
 - 1 Dot = 1.5 DEG
 - 2 Dots = 3.0 DEG
 - Glide Slope Sensitivity
 - 1 Dot = 0.35°
 - 2 Dots = 0.70°

STEER, L5 and L6. The CDU provides four steer modes: TO FROM, DIRECT, TO TO, and SCS. The TO FROM, DIRECT, and TO TO steer modes are waypoint and/or flight plan specific attributes. The steer attribute displayed on the Attributes (ATTRIB) Page or Waypoint (WAYPT) Page 2/2 is waypoint specific. The steer attribute displayed on the Waypoint Attributes (WPTATT) Page is flight plan specific. The SCS mode is not an attribute and can only be selected/deselected on the ATTRIB Page. The waypoint specific steer attribute is entered/changed using the ATTRIB Page or WAYPT Page 2/2. The flight plan specific steer attribute is entered/changed using the WPTATT Page.

Note:

- When ANCHR is selected, the SCS steer mode cannot be selected on the ATTRIB Page (SCS LSK is inactive).
- If the SCS steer mode has been selected and then ANCHR is selected on the NMSP, the SCS mode is automatically deselected, and steering cues are provided to the anchor point. These steering cues are determined by the attributes of the waypoint that is the anchor point.
 - **TO FROM** - the commanded course is the great circle path along the course entered via the HSI COURSE SET knob to/from the selected steerpoint.
 - **DIRECT** - the commanded course is the great circle path from the aircraft position at the time the DIRECT mode is selected to the selected steerpoint. Subsequently, each time a new steerpoint is selected, a course is computed from the aircraft's position at that instant to the new steerpoint.
 - **TO TO** - the commanded course is the great circle path from the designated From point, displayed on the CDU FROM Page, to the selected steerpoint.
 - **SCS** - the commanded course is manually selected course away from the point where the aircraft was located at the time SCS is selected.

Note:

- The TO FROM and SCS steer modes require that a selected course be entered using the COURSE SET knob on the HSI if you want consistent HSI course deviation indicator, ADI bank steering bar, and CDU Position (POS) Page cross track deviation (CROSS TRKDEV) indications.
- In the DIRECT and TO TO steer modes, the course arrow on the HSI should be set to the course indicated on the ATTRIB Page, using the COURSE SET knob on the HSI, for a consistent HSI course deviation indicator, ADI bank steering bar, and CDU POS Page cross track deviation (CROSS TRK DEV) indications.
- In the TO FROM, DIRECT, and TO TO modes, the TO steerpoint is shown in the upper right corner of the CDU as the waypoint (e.g., 1). In the SCS mode, this is replaced by SCS.
- When ANCHR is selected, the SCS steer mode cannot be selected on the ATTRIB Page (SCS LSK is inactive).
- If the SCS steer mode has been selected and then ANCHR is selected on the NMSP, the SCS mode is automatically deselected, and steering cues are provided to the anchor point. These steering cues are determined by the attributes of the waypoint that is the anchor point.
- The SCS steer mode is not an attribute and can only be selected or deselected on the ATTRIB Page.
- When the SCS steer mode is selected, SCALE and 2D or 3D can be selected to provide the desired steering cues.
- The CDU provides four scale modes: ENROUTE, TERMINAL, high accuracy (HIGH ACC), and APPROACH.

Vertical Navigation Mode, R5. Press this LSK to cycle between 2D and 3D navigation. When in 3D navigation, vertical angle input may be selected.

3D Mode: When in 3D mode, a vertical angle can be automatically computed, or you can enter one manually. This will then drive the ADI steering indications in the vertical according to the VNAV setting.

2D Mode: Only horizontal heading data is passed to the HSI and ADI.

Selected Vertical Angle, R4. Press this LSK to select between COMPUTED and ENTERED when in 3D vertical navigation mode. When COMPUTED is selected, vertical steering will be automatically

computed between the TO and FROM points. When in ENTERED mode, use the scratchpad to enter the desired angle and then press the LSK to enter the value.

Desired Time to Go (DTTG) Entry Line Select Key, L7. Allows desired time to go to selected waypoint to be entered from scratchpad in hours, minutes, and seconds (1 to 24000). When the DTTG is entered, the DTOT is automatically updated to reflect the new DTTG. Clearing DTTG (scratchpad empty and pressing this line select key) will cause both DTOT and DTTG fields to display 8 asterisks. When a DTOT or DTTG has not been entered or uploaded from DTS, this field and the DTOT field will display 8 asterisks.

Desired Time on Target (DTOT) Entry Line Select Key, L9. Allows desired time of arrival at selected waypoint to be entered from scratchpad in hours, minutes, and seconds (1 to 225959). When the DTOT is entered, the DTTG is automatically updated to reflect the new DTOT. Clearing DTOT (scratchpad empty and pressing this line select key) will cause both DTTG and DTOT fields to display 8 asterisks. When a DTOT or DTTG has not been entered or uploaded from DTS, this field and the DTTG field will display 8 asterisks.

Scratchpad, L10. Scratchpad field.

WP / ANCHOR Sub-Page

The ANCHOR page is displayed when the ANCHOR PT Page line select key is depressed within the WP MENU Page. Also referred to as a "Bullseye", the anchor point is an arbitrary geographic location that is used as a common reference for units operating in the same general area. The anchor point may be displayed on the Tactical Awareness Display (TAD) and as data on the HUD.



Figure 199. WP / Anchor Sub-Page

Anchor Point Entry Line Select Key, L3. Allows you to select and enter an anchor point from the scratchpad as follows:

If a number from 0 to 2050 is entered in the scratchpad (a mission or navigation waypoint is assumed) and then this line select key pressed, the waypoint with the number displayed in the scratchpad becomes the anchor point.

If an alphabetical character from A to Z is entered in the scratchpad (a markpoint is assumed) and then this line select key is pressed, the markpoint with the alphabetical character displayed in the scratchpad becomes the anchor point.

You can also use the \pm rocker switch on the CDU to select the anchor point within the displayed waypoint database without using the line select key.

If an invalid waypoint number or markpoint letter is entered, "CDU INPUT ERR" is displayed on the scratchpad and will remain until cleared by pushing the CLR Button.

If no anchor point has been entered or uploaded from DTS, this field will display 5 asterisks.

Anchor Point Identifier Line Select Key, L5. Allows entry from scratchpad of anchor point identifier, up to 12 alphanumeric characters. If two or more characters are entered (with the first an alpha character), a search through the waypoint ID database is assumed as described in the Standard Line 10 Display previously. Once the desired waypoint identifier is in the scratchpad, pressing this LSK will designate that waypoint as the anchor point and the remaining anchor point information will be calculated/displayed.

If this line select key is pressed when the identifier in the scratchpad is not present in the waypoint ID database, "CDU INPUT ERR" is displayed on the scratchpad and will remain until cleared by pushing the CLR Button.

If no anchor point has been entered or uploaded from DTS, this field will display 12 asterisks.

Time to Go (TTG) to Anchor Point, L6. Displays time to anchor point at current ground speed in hours, minutes, and seconds. When ground speed is less than 3 knots or when an anchor point has not been entered or uploaded from DTS, TTG to anchor point will display 8 asterisks.

Desired Magnetic Heading (DMH) to Anchor Point, L7. Displays wind corrected magnetic heading to anchor point in degrees. When an anchor point has not been entered or uploaded from DTS, DMH will display 3 asterisks.

Distance (DIS) to Anchor Point, L8. Displays ground distance to anchor point in nautical miles (0 to 9999). When the distance is less than 100 nautical miles, tenths of a nautical mile are displayed. When the distance is equal to or greater than 100 nautical miles, only whole nautical miles are displayed which are rounded off to the nearest nautical mile. When the distance exceeds 9998.5

nautical miles, the distance field will display "9999." When an anchor point has not been entered or uploaded from DTS this field displays 3 asterisks.

Steerpoint Identifier Entry Line Select Key, R3. When AAP STEER PT switch is set to MISSION or MARK, it allows the operator to select a steerpoint by using the scratchpad (waypoint search procedure as described above) and then pressing this line select key. When AAP STEER PT switch is set to FLT PLAN, this line select key is inactive (no brackets symbol displayed) and the field displays the identifier of the selected steerpoint, and the steerpoint can only be changed by using the STEER toggle switch on the AAP or UFC.

If this line select key is pressed when the identifier in the scratchpad is not present in the waypoint ID database, "CDU INPUT ERR" is displayed on the scratchpad and will remain until cleared by pushing the CLR Button.

Time to Go (TTG) to Steerpoint, R6. Displays time to steerpoint at current ground speed, shown in hours, minutes, and seconds. When ground speed is less than 3 knots, TTG to steerpoint will display 8 asterisks.

Desired Magnetic Heading (DMH) to Steerpoint, R7. Displays wind corrected magnetic heading to steerpoint in degrees.

Distance (DIS) to Steerpoint, R8. Displays ground distance to steerpoint in nautical miles. When the distance is less than 100 nautical miles, tenths of a nautical mile are displayed. When the distance is equal to or greater than 100 nautical miles, only whole nautical miles are displayed which are rounded off to the nearest nautical mile. When the distance exceeds 9998.5 nautical miles, the distance field will display "9999."

Anchor data on HUD, L9. Press this LSK to turn the anchor point data block on the HUD OFF and ON.

Other Displays Affected by Anchor Page. Setting or changing an anchor point affects the following pages:

HUD Display: The upper right-hand corner of the HUD displays the ANCHOR point identifier and the bearing/distance from that point to the aircraft.

WP Info Display: The ANCHOR point information is displayed and updated on the WP INFO Page Display.

Scratchpad, L10

WP / From Point (FROM PT) Sub-Page

When a waypoint is in TO TO steering mode, you can manually set the waypoint that the navigation is based FROM.



Figure 200. WP / From Point Sub-Page

FROM Point Entry Line Select Key, L3. Allows you to select and enter the FROM point from the scratchpad as follows:

If a number from 0 to 2050 is entered in the scratchpad (a mission or navigation waypoint is assumed) and then this line select key pressed, the waypoint with the number displayed in the scratchpad becomes the initial point.

If an alphabetical character from A to Z is entered in the scratchpad (a markpoint is assumed) and then this line select key is pressed, the markpoint with the alphabetical character displayed in the scratchpad becomes the initial point.

You can also use the \pm rocker switch on the CDU to select the anchor point within the displayed waypoint database without using the line select key.

If an invalid waypoint number or markpoint letter is entered, "CDU INPUT ERR" is displayed on the scratchpad and will remain until cleared by pushing the CLR Button.

If no anchor point has been entered or uploaded from DTS, this field will display six asterisks.

FROM Point Identifier Line Select Key, L5. Allows entry from scratchpad of the FROM point identifier, up to 12 alphanumeric characters. If two or more characters are entered (with the first an alpha character), a search through the waypoint ID database is assumed as described in the Standard Line 10 Display previously. Once the desired waypoint identifier is in the scratchpad,

pressing this LSK will designate that waypoint as the anchor point and the remaining anchor point information will be calculated/displayed.

If this line select key is pressed when the identifier in the scratchpad is not present in the waypoint ID database, "CDU INPUT ERR" is displayed on the scratchpad and will remain until cleared by pushing the CLR Button.

If no anchor point has been entered or uploaded from DTS, this field will display 12 asterisks.

Alternate Coordinate Format Rotary Line Select Key, R3. Allows rotary selection of either "L/L" for Latitude Longitude format or "UTM" for Universal Transverse Mercator (UTM) coordinates. L/L is the default setting.

L/L format:

L7. Waypoint Latitude Entry Line Select Key. Allows entry of waypoint latitude in degrees, minutes and thousandths of a minute.

L9. Waypoint Longitude Entry Line Select Key. Allows entry of waypoint longitude in degrees, minutes and thousandths of a minute.

UTM format:

L7. Waypoint Grid and Spheroid Entry Line Select Key. Allows entry of waypoint UTM grid zone of up to two numeric characters and one alpha character, where ## is the grid zone number and N is the grid zone letter. The Spheroid will always be WGS84.

L9. Waypoint Area, Eastings, Northings Entry Line Select Key. Allows entry of area in two alpha characters and eastings and northings in up to 10 digits. A is column letter, B is row letter, XXXXX is easting value, and YYYYY is northing value. This line select key is inactive (no brackets symbol displayed) for navigation waypoints (51 through 2050) and markpoints (A through Z).

Scratchpad, L10

OFFSET Page

The OFFSET page is displayed when the AAP Page Select Switch is in OTHER and the OSET FSK is depressed. The OFFSET Page allows calculations from an initial point to (1) another waypoint, (2) a set of coordinates, or (3) a point defined a heading/distance from the initial point. In this way, you can compute displacements between two points. The process is as follows:

Select the initial waypoint.

Select the offset waypoint (LSK R9), coordinate (LSK L7 and L9), or entered heading and distance (LSK R5).

The offset magnetic heading and distance will then be displayed (R6).



Figure 201. Offset Page

Initial Waypoint Entry Line Select Key, L3. Allows you to select and enter an initial waypoint from the scratchpad as follows:

If a number from 0 to 2050 is entered in the scratchpad (a mission or navigation waypoint is assumed) and then this line select key pressed, the waypoint with the number displayed in the scratchpad becomes the initial point.

If an alphabetical character from A to Z is entered in the scratchpad (a markpoint is assumed) and then this line select key is pressed, the markpoint with the alphabetical character displayed in the scratchpad becomes the initial point.

You can also use the \pm rocker switch on the CDU to select the anchor point within the displayed waypoint database without using the line select key.

If an invalid waypoint number or markpoint letter is entered, "CDU INPUT ERR" is displayed on the scratchpad and will remain until cleared by pushing the CLR Button.

The default initial waypoint is 0 (zero).

Initial Waypoint Identifier Line Select Key, L5. Allows entry from scratchpad of waypoint identifier, up to 12 alphanumeric characters. If two or more characters are entered (with the first an

alpha character), a search through the waypoint ID database is assumed as described in the Standard Line 10 Display previously. Once the desired waypoint identifier is in the scratchpad, pressing this LSK will designate that waypoint as the initial waypoint.

If this line select key is pressed when the identifier in the scratchpad is not present in the waypoint ID database, "CDU INPUT ERR" is displayed on the scratchpad and will remain until cleared by pushing the CLR Button.

Alternate Coordinate Format Rotary Line Select Key, R3. Allows rotary selection of either "L/L" for Latitude Longitude format or "UTM" for Universal Transverse Mercator (UTM) coordinates. L/L is the default setting.

L/L format:

L7. Waypoint Latitude Entry Line Select Key, L7. Allows entry of waypoint latitude in degrees, minutes and thousandths of a minute.

L9. Waypoint Longitude Entry Line Select Key, L9. Allows entry of waypoint longitude in degrees, minutes and thousandths of a minute.

UTM format:

L7. Waypoint Grid and Spheroid Entry Line Select Key. Allows entry of waypoint UTM grid zone of up to two numeric characters and one alpha character, where ## is the grid zone number and N is the grid zone letter. The Spheroid will always be WGS84.

L9. Waypoint Area, Eastings, Northings Entry Line Select Key. Allows entry of area in two alpha characters and eastings and northings in up to 10 digits. A is column letter, B is row letter, XXXXX is easting value, and YYYYY is northing value This line select key is inactive (no brackets symbol displayed) for navigation waypoints (51 through 2050) and markpoints (A through Z).

Copy Action Line Select Key, R7. Allows operator to store offset coordinates as a mission waypoint by depressing copy line select key which stores the offset waypoint data at next available mission number; next available location is displayed next to the target symbol.

Magnetic Heading/Distance (MH/DIS) Entry Line Select Key, R5 and R6. Allows you to compute an offset from the initial waypoint. Magnetic heading and distance are entered as HHHDD.T when the distance is less than 100 NM, HHHDDD.T when the distance is 100 NM or more but less than 1000 NM, and HHHDDDD.T when the distance is 1000 NM or more and equal to or less than

9999.9 NM. The magnetic heading and distance are entered/displayed when this line select key is pressed.

When the entered distance is less than 100 NM, this field will display NM and tenths of an NM. When the entered distance is equal to or more than 100 NM, this field will display only NM (no tenths); however, if tenths of an NM were entered, this value will be used in calculating the offset position. The created offset waypoint coordinates are displayed at lower left, and offset waypoint database and number field will be asterisks.

This field also displays the magnetic heading and distance (up to 9999 NM) for a computed offset between waypoints and is entered as geographical coordinates. When a new offset waypoint number/letter is entered (as defined below) the MH/DIS field will be computed/displayed from the initial waypoint to the offset waypoint.

When a new latitude/longitude/UTM grid/area, eastings or northings are entered (as defined above), the MH/DIS field will be computed/displayed from the initial waypoint to the new coordinates.

When the computed offset distance is less than 100 NM, this field will display NM and tenths of an NM. When the computed offset distance is equal to or more than 100 NM, this field will display NM (no tenths). If the computed offset distance is greater than 9998.5 NM, this field will display "9999." Offset waypoint coordinates are displayed at lower left, and the offset waypoint number display will be asterisks.

The default heading and distance shown is from the initial point to the offset waypoint described below.

If the magnetic heading/distance does not follow the input format described above and the LSK is pressed, a "CDU INPUT ERR" will be displayed in the scratchpad and will remain until cleared by pushing the CLR Button.

The tenths input is optional.

Offset Waypoint Entry Line Select Key, R9. Allows the operator to select and enter an offset waypoint from the scratchpad as follows:

If a number from 0 to 2050 is entered in the scratchpad (an offset waypoint is assumed) and then this line select key is pressed, the offset magnetic heading/distance is computed and displayed below the MH/DIS field. It also causes the offset waypoint coordinates to be displayed at the lower left in the applicable format.

If an alphabetical character is entered in the scratchpad (an offset waypoint is assumed) and then this line select key is pressed, the offset magnetic heading/distance is computed and displayed below the MH/DIS field. It also causes the waypoint coordinates to be displayed at the lower left in the applicable format.

If an invalid waypoint number or markpoint letter is entered, "CDU INPUT ERR" is displayed on the scratchpad and will remain until cleared by pushing the CLR Button.

If new latitude/longitude or UTM coordinates are entered from scratchpad, the offset waypoint number changes to 4 asterisks, and the MH/DIS field displays the magnetic heading and distance to the entered coordinates.

The default offset waypoint is 0 (zero).

Scratchpad, L10.

FLIGHT PLAN MENU (FPM) Page

The Flight Plan Menu page is displayed when the AAP Page Select Switch is in OTHER and the FPM FSK is depressed. This page allows you to select a flight plan, create a new one, or edit an existing one. You can have up to 20 flight plans, each consisting of up to 40 waypoints.



Figure 202. Flight Plan Menu Page

Activate Flight Plan (Target Symbol)/Sequencing Mode (Rotary Symbol) Line Select Keys, L3, L5 and L7. Pressing the activate flight plan (target symbol) line select key next to a flight number and name:

- Deactivates the flight plan that was active.

- Activates the flight plan that was selected.
- Causes the active flight plan indicator (*) to be displayed to the right of the selected flight plan.
- Causes the flight plan sequencing mode indicator to indicate the selected sequencing mode. Default mode is manual (MAN).
- Causes the target symbol of the flight plan that was selected to change to the sequencing mode (up and down arrow) symbol. With the rotary symbol displayed, the sequencing mode can be toggled between automatic (AUTO) and manual (MAN) sequencing.

Active Flight Plan Indicator. An asterisk (*) is displayed to the right of the flight plan name that is active.

For the active flight plan to provide steering cues, the STEER PT switch on the AAP must be set to FLT PLAN.

Flight Plan Sequencing Mode Indicator, L3, L5 and L7. The flight plan sequencing mode indicator indicates the selected flight plan sequencing mode for the active flight plan (MAN or AUTO). Manual (MAN) is the default flight plan sequencing mode. The line select key next to the active flight plan is used to toggle between the MAN and AUTO modes.

Branch to Flight Plan Build (FPBUILD) Page, R3, R5, or R7. When pressed, causes the Flight Plan Build (FPBUILD) sub-page associated with the flight plan whose number and name appear to the left of the line select key that was pressed to be displayed. This sub-page allows you to edit and create new flight plans.

Name New Flight Plan Line Select Key, L9. The fields associated with this line select key display the number to be assigned to the flight plan to be created; and (NEW FP) which is constant and informs that this is the line select key used to create new flight plans. These fields are displayed on line 9 on all FPMENU Pages. When a new flight plan name is entered in the scratchpad and then this line select key is pressed, the Flight Plan Build (FPBUILD) Page for the new flight plan is displayed.

If the flight plan database is full (maximum of 20 flight plans), (NEW FP) field will display (FULL) and this line select key will be inactive (brackets symbol and flight plan number will be blank).

If this line select key is pressed with the scratchpad empty, input error will be displayed in the scratchpad.

Scratchpad, L10.

To create a new flight plan:

1. Enter unique name of flight plan in scratchpad.
2. Press LSK at L9 (NEW FP).
3. A new FP with the entered name will now be displayed on the flight plan list.
4. To set the flight plan to manual next waypoint selection or automatic next waypoint selection, press the LSK left of the active flight plan.

FPM / FLIGHT PLAN BUILD (FPBUILD) Sub-Page

The FPBUILD pages are displayed when the FPBUILD LSK is depressed in the FP MENU Page. This page allows you to add or remove waypoints from a flight plan.



Figure 203. FPM / Flight Plan Build Sub-Page

Flight plan name (NM:), L3. Name of the flight plan.

Flight plan number, L4. Displays "F" and the number of the flight plan being displayed.

INSERT mode, R3. Allows insertion of additional waypoints into existing flight plan.

Waypoints, L5, L7 and L9. Used to delete or overwrite flight plan waypoints.

Waypoint sequence numbers, L5, L7 and L9. Indicates the sequence of the associated waypoint in the displayed flight plan:

- Waypoint identifiers
- Active steerpoint indicator

For a detailed explanation of using this page to create and edit a flight plan, please consult the Navigation chapter of this manual.

To add a new waypoint in sequence to a flight plan:

1. Enter number of desired waypoint in scratchpad
2. Press LSK corresponding to (NEXT) waypoint field

To insert a waypoint between waypoints of an existing flight plan, press the INSERT WPTATT LSK at R3.



Figure 204. FPM / Flight Plan Build Sub-Page, Insert WP

The active flight plan will then be displayed. Between each flight plan are open slots to insert a new waypoint. To insert a waypoint, enter the desired waypoint number in the scratchpad and then press the LSK corresponding to the location you want the waypoint inserted (i.e., 01, 02, etc.).

Note that you must set the STEER PT dial to FLT PLAN to have the flight plan displayed on the Tactical Awareness Display (TAD).

Note that when a flight plan is selected and HUD is SOI, HOTAS DMS switch up and down can be used to cycle the waypoints of the flight plan.

UP FRONT CONTROLLER (UFC)

The UFC is a new addition to the A-10C and allows much easier entry of and searching for data compared to the earlier A-10A. The UFC consists of a combination of buttons and rocker switches that allow you to communicate with the CDU and MFCD data content while keeping your eyes out of cockpit. For many functions, you have the option to use either the UFC or CDU.

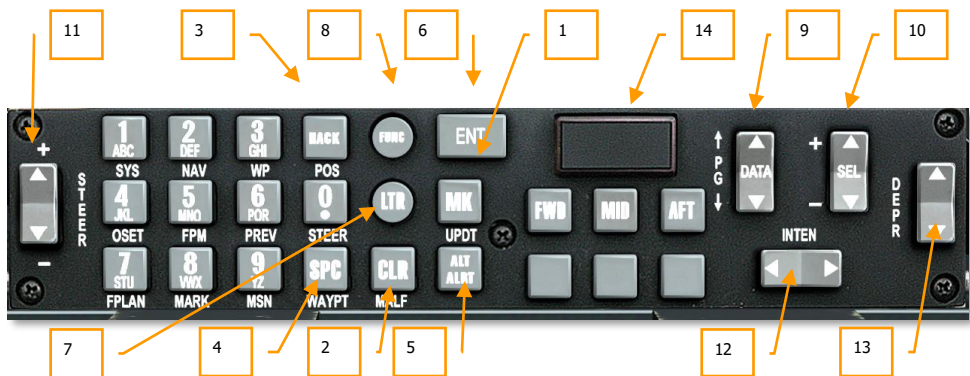

Figure 205. Up Front Controller

Special Purpose Buttons

The UFC has 10 alphanumeric buttons (0–9) located on the left side of the controller as well as six special purpose buttons. These special purpose buttons are:

1. **Mark (MK).** The Mark (MK) button is a repeater of the CDU MARK button. Depressing the MK button generates a new markpoint in the CDU at the current coordinates of the aircraft. Reference the CDU section for more detail on creating markpoints.
2. **Clear (CLR).** Depressing the Clear (CLR) button removes one character from the HUD and CDU scratchpad (i.e., performs a backspace function). Depressing and holding the CLR button for greater than 0.5 seconds causes the entire scratchpad to clear.
3. **Time Hack (HACK).** Depressing the HACK button enters the HACK mode and displays the Hack Time-To-Target value boxed on the lower right side of the HUD. Depressing the HACK key again returns the display to real-time mode. Hack time can be adjusted by using the DATA rocker switch to adjust hack time and depressing the ENT key to accept. Hack time may also be

entered manually via the scratchpad and depressing ENT to accept. Reference the HUD section for more detail on the HACK function.

4. **Space (SPC).** Depressing the Space (SPC) button inserts one space into the HUD and CDU scratchpads.
5. **Altitude Alert (ALT ALRT).** Depressing the Altitude Alert (ALT ALRT) button displays the current AGL Altitude Alert Value in the HUD. Subsequent depressions cycle through the MSL Altitude Alert Value and MSL Ceiling Alert Value. A fourth depression exits this function. While a value is displayed in the HUD, it can be adjusted using the DATA rocker switch or by entering a value in the scratchpad and depressing the ENT button.
6. **Enter (ENT).** The Enter (ENT) button has several functions based on the current UFC operating mode:
 - 6.1. Selects the Menu/Submenu item indicated by the HUD cursor position in HUD Test Mode
 - 6.2. Performs actions in menus and submenus
 - 6.3. Enters a target elevation update for the current steerpoint
 - 6.4. Accepts time-to-target selected by the DATA rocker switch in HACK Mode
 - 6.5. Accepts boresight adjustments in Maverick HUD Boresight Mode

UFC Operating Mode Buttons

In addition to the square and rectangular buttons that perform a specific action, the UFC also contains two round buttons that place the UFC in a modal type:

7. **Letter (LTR) Mode.** Letter mode allows you to enter letter characters on the HUD and CDU scratchpads. Letter mode is active whenever the LTR button is pressed. In Letter mode, depression of the number key causes the first letter in the multi-letter string to be displayed. Subsequent depressions of the same number key cycles through the letter string (like a cell phone). After a 1-second delay with no further switch actuations, the scratchpad cursor moves to the next space (blank character), and the next desired letter is entered by depressing another key in a similar manner. Also, if a different number key is depressed before the 1-second timeout, a letter is added to the next space. When in this Letter mode, an "L" is displayed right justified on the HUD scratchpad.

To keep Letter mode always on and only enter letters, the user may press the LTR button twice. Upon doing so, an underlined "L" will be displayed right justified on the HUD scratchpad. To return to non-Letter mode, the user presses the LTR button a third time.

8. **Function (FUNC) Mode.** The FUNC key is used to engage the Function Mode, allowing the remote selection of the CDU and AAP functions listed underneath the 14 buttons. The function that is assigned to a button is listed in white underneath the button. The non-function action of the button is listed on the button/switch. To select a function, you will first click the FUNC button and then the desired function listed below. When in function mode, an "F" is displayed right justified on the HUD scratchpad. After a function has been selected, the function selection mode is deselected automatically, and button presses respond normally. However, two consecutive presses of the FUNC key will set the function mode to on until it is pressed a third time. When in this always-on mode, an underlined "F" is displayed right justified on the HUD scratchpad.

- SYS – same as CDU system function select key
- NAV – same as CDU navigation function select key
- WP – same as CDU waypoint function select key
- OSET – same as CDU offset function select key
- FPM – same as CDU flight plan manager function select key
- PREV – same as CDU previous function select key
- The above six functions act as CDU repeaters.
- FPLAN – same as FLT PLAN from left AAP dial
- MARK – same as MARK from left AAP dial
- MSN – same as MISSION from left AAP dial
- The above three functions act as left AAP dial repeaters.
- POS – same as POSITION setting from right AAP dial
- STEER – same as STEER setting from right AAP dial
- WAYPT – same as WAYPT setting from right AAP dial
- The above three functions act as right AAP dial repeaters.
- MALF – Clear HUD Malfunction (Not Functional)
- UPDT – HUD Update (Not Functional)

When in function mode, CDU actions, page navigations and waypoint selection overrides whatever the AAP dial is set to. AAP settings regain control if they are set from the AAP panel.

When in Function Mode, the Page (PG) up/down and SEL +/- rocker switches are repeaters of the corresponding CDU rocker switches. The STEER +/- rocker switch is a repeater of the CDU Left/Right rocker switch used in conjunction with the waypoint ID search engine.

Numeric Mode (Default). Numeric mode is active whenever the UFC is not in either Letter (LTR) or Function (FUNC) mode and is the default state upon power up of the UFC. In Numeric mode, depression of the desired numeric character causes that number to be displayed in both the HUD and CDU scratchpads.

Rocker Switches

The UFC contains 5 rocker switches that allow you to cycle/select information.

The five rockers include:

9. **DATA.** The rocker located on the right side of the UFC has "PG" listed to the left of it with up and down arrows. In the center of the rocker, "DATA" is displayed. The DATA rocker has different functions based on operating mode:

The rocker alters data in menus and displays in HUD TEST, NAV, GUNS, CCIP, CCRP, and AIR-to-AIR Modes

When toggled in NAV, GUNS, CCIP, and CCRP modes, the switch will cause target elevation to flash on the HUD display to indicate elevation can be changed

The switch will increment/decrement displayed HACK time interval displayed in HUD HACK TIME Mode

The switch performs the same function as the CDU PG rocker switch in FUNC Mode

10. **SEL.** The Select (SEL) rocker is located on the right side of the UFC and has + and - symbols to the left of it. In the center of the rocker, "SEL" is displayed. This rocker has different functions based on operating mode:
 - Navigates menus in HUD TEST Mode
 - Changes weapon profiles in CCIP/CCRP Mode
 - Changes gun reticles in GUNS Mode
 - Changes selected air-to-air threat in AIR-to-AIR Mode
11. **STEER.** Located on the left side of the UFC, this rocker has "STEER" displayed vertically to the right of the rocker and + and – symbols above and below it. The STEER rocker switch repeats the function of the STEER Toggle Switch on the Avionics Auxiliary Panel (AAP). In FUNC Mode, the STEER switch functions as a repeater of the CDU LEFT/RIGHT Rocker switch, which is used to toggle through the waypoint ID database in conjunction with the waypoint ID search engine.
12. **INTEN.** Located horizontally along the lower right portion of the UFC, "INTEN" is displayed above the rocker. The Intensity (INTEN) rocker switch controls HUD display brightness.
13. **DEPR.** Located on the right edge of the UFC, the rocker has "DEPR" displayed vertically to the left. The Depression (DEPR) rocker switch enables the depressible pipper on the HUD to be manually depressed over a range of +10 to -300 mils referenced to Zero Sight Line (ZSL).

Momentary depressions of the rocker switch move the applicable pipper up or down one milliradian.

14. **Master Caution.** The MASTER CAUTION light is in the upper right portion of the UFC and has "MASTER CAUTION" displayed in its center in two lines. By clicking on this button, you may reset a light on the caution panel. The Master Caution light will illuminate when a new light has been illuminated on the caution panel. Clicking the MASTER CAUTION button will cause a flashing light on the caution panel to go steady and the MASTER CAUTION light will go off.

This function does not clear Warnings, Cautions and Notes (WCNs) on the HUD or MFCDs.

CDU/AAP Relation to UFC

Most of the functions of the UFC have corresponding functionality on the AAP and CDU. The images below use like-colors to illustrate these relationships.



Figure 206. CDU/AAP Relation to UFC

To better illustrate the functional relationship between the CDU, AAP and UFC, a system of color coding will be used on labels of similar functions.

- All labels pertaining to right AAP dial will be colored yellow.
- All labels pertaining to the left AAP dial will be colored orange.
- All labels pertaining to the CDU function select keys will be colored blue.

The above graphic illustrates this colored label relationship.

MULTIFUNCTION COLOR DISPLAY (MFCD) PAGES

An important improvement between the older A-10A and the A-10C was the inclusion of two 5x5 inch MFCDs. This has streamlined the dataflow to the pilot and made much more information readily accessible. Please consult the Cockpit Controls chapter of this manual regarding more information about the MFCD units.

The primary purpose of the MFCDs is to display a wealth of data over a variety of pages. The primary MFCD pages of the A-10C include:

Data Transfer System (DTS) Page. Load navigation and weapon data from the mission planner into the aircraft. In the real-world, this would be done with a Data Transfer Cartridge that loads data from the Mission Planning Software onto the aircraft.

Display Program (DP) Page. Configure which page-links are to be displayed on the bottom of each MFCD.

Status (STAT) Page. Review status of A-10C sub-systems.

Digital Stores Management System (DSMS) Page. Manage the stores of the aircraft.

Tactical Awareness Display (TAD) Page. Use the digital, moving map for navigation, targeting, and datalink purposes.

Targeting Pod (TGP) Page. Use the Litening AT targeting pod.

Maverick (MAV) Page. Employ various models of the AGM-65 Maverick air-to-surface missile.

Message (MSG) Page. Send and receive text messages with other units on SA Link network.

Control Data Unit (CDU) Repeater Page. View the CDU screen display on an MFCD.

Data Transfer System (DTS) Upload Page



Figure 207. DTS Upload Page

When the AHCP CICU switch is set to ON and both MFCs have been turned on, both MFCs will activate and display the DTS page. This will be the first page you will configure, and it allows you to load both navigation and weapons data created in the Mission Planner to the aircraft EGI and DSMS systems.

In the real world, this data is loaded onto a cartridge the pilot writes from their mission planning software. The pilot then takes the cartridge to the jet and loads it prior to flight via the DTS page.

You will generally always want to do a LOAD ALL at the start of every mission starting from the parking ramp.

From the DTS Upload page, you may select any of the five upload options:

- Display Program Page Selections (LOAD PAGE)
- TAD Profiles (LOAD TAD)
- DSMS Inventory and Profile Data (LOAD DSMS)
- Targeting Pod Configuration (LOAD TGP)

- All DTS Data (LOAD ALL). This is the recommended choice.

Once a DTS load has been initiated by pressing the system action OSB, you cannot initiate any new actions on the DTS Upload page for 15 seconds while the load takes place. During the 15 seconds that the DTS data is being uploaded, all system action characters except for the load option selected are removed from the DTS page on both MFCDs. When the load is complete after 15 seconds, all system action characters will return.

Display Program (DP) Page



Figure 208. Display Program Page

Along the bottom of both MFCDs are four OSB (12 through 15) that can be assigned to directly link to any of the main MFCD pages. By pressing and holding any of these four OSB for more than 1 second the Display Program Page will appear.

By default, both MFCDs will have pages assigned to OSB 12 through 15; these default settings, however, can be changed using the Display Program Page.

Once the Display Program Page is displayed and you wish to assign a display page to one of the bottom OSB, you need to do the following:

Select an OSB from OSB 7 through 9 or OSB 16 through 20. Next to each of these OSB is a label regarding display page function. Selecting one of these OSB highlights the adjacent label in reverse video. If another OSB display page is selected, the previous one un-highlights.

Once you have selected the display page, select one of the 12 through 15 OSB. This will assign the selected OSB display page to that OSB. Upon doing so, the selected 12 through 15 OSB will change its label to match the selected OSB page. The selected OSB program page will be un-highlighted.

To remove a page assignment from OSB 12 through 15, press the Clear (CLR) OSB 10. Then press the 12 through 15 OSB to be cleared. Upon doing so, the label above the selected OSB is removed.

If more than one 12 through 15 OSB is assigned the same OSB program page, then the older one is cleared.

To exit the Display Program Page, press any of the 12 through 15 OSB, which will direct the user to the OSB specified page.

Status (STAT) Page

System Status (STAT) consists of two pages that allow you to view the status of multiple avionics units (LRU and SRU).

OSB 1 will allow the user to cycle between page 1 and page 2 of the STAT page.

The OSB 19 and 20 navigation functions allow the user to scroll between LRU/SRU items.

Upon selection of STAT as a page select OSB, the below page is displayed.

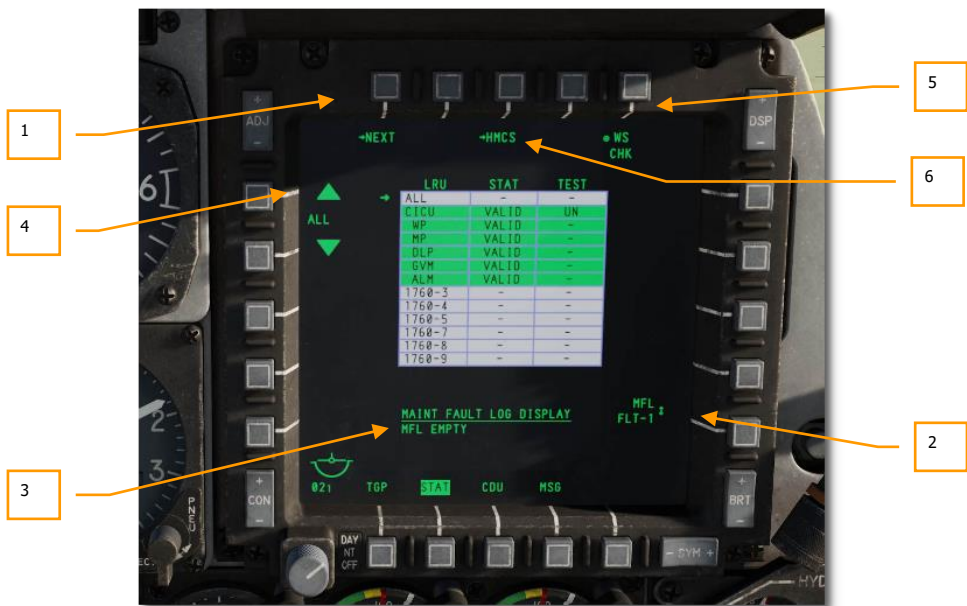

Figure 209. Status Page 1

1. **Next Page (NEXT)**, branch OSB 1. Left button mouse clicking on OSB 1 will direct to the second page of STATUS.
2. Maintenance Fault Log of Previous Flight (MFL FLT-1), rotary OSB 10. No function. Label displayed as:
MFL
FLT-1
3. **LRU/SRU Information**. When an SRU/LRU line on the table is selected, additional information about the selected item can be displayed centrally below the table. The information displayed here may vary according to the selected item.
4. **Select LRU/SRU (LRU/SRU item name)**, navigation OSB 19 and 20. Pressing the Up arrow next to OSB 20 will cycle the arrow left of the table up, and pressing the Down arrow next to OSB 19 will cycle the arrow down the table. When the arrow reaches the top or bottom of the table, it will wrap. The LRU/SRU that the arrow is pointed towards is the selected item (name

displayed between OSB 19 and 20) and the information on the display may vary according to the LRU/SRU.

In the center of the page is a table that lists each of the LRU/SRU items. The table is divided into three columns: LRU, STAT and TEST. These labels are listed above the table in-line with the column.

All LRU/SRU lines/columns are colored green when on and operating normally. They are colored red when a fault has been detected. Items colored white are non-applicable.

5. **Weapon Station Check (WS CHK).** This performs a system check of the selected LRU/SRU (no function).

Some LRU/SRU items will also have a TEST OSB option when selected, like the CICU. When pressed, a TEST OSB will run a BIT of the selected unit.

6. **Helmet Mounted Cueing System (HMCS) Profile Set up.** This allows the configuration of three display profiles for the HMCS.

STAT Page 1

In the LRU column, the following items will be listed:

- ALL
- CICU
- WP
- MP
- DLP
- GVM
- ALM
- 1760-3
- 1760-4
- 1760-5
- 1760-7
- 1760-8
- 1760-9

The STAT column may list "VALID", "TEST", "DEGR", "NC" and "OFF" depending on the state of the item.

The TEST column displays the following information for the LRU/SRU along the same line:

UN

-

Note: If an IAM 1760 station has failed, you will need to cycle POWER OSB to clear the FAIL status.

STAT Page 2



Figure 210. Status Page 2

As with page 1, page 2 also contains a 3-column table for LRU, STAT and TEST.

Items in the LRU column include:

- TGP
- LTMFCD
- RTMFCD
- HOTAS
- STICK
- THRTL. Adjust the slew function here to control slew rate of cursor on TAD, TGP and HUD.

- AHCP
- EGI
- IFFCC
- CDU
- EPLRS

Except for two exceptions, all OSB functions are the same between the two pages. The exceptions are:

- **Return to Page 1 of STAT (PREV)**, branch OSB 1. Left mouse button clicking OSB 1 will return the user to page 1 of STAT.
- **Enter Slew Value (SLEW)**, data entry OSB 8. This is only displayed when the throttle LRU is selected. Adjusting this value allows you to adjust the slew speeds of the cursors.

Digital Stores Management System (DSMS) Page

The DSMS replaces the old A-10A Armament Control Panel (ACP). All the settings for weapons, release parameters, and control of the various types of armament are now handled using the DSMS pages on an MFCD.

The DSMS provides you with an overall display of weapons status, inventory of each station on the aircraft, which stations are selected, the arm state, status of the GAU-8 gun, and what profile is currently selected for each weapon.

The DSMS also contains a separate page that provides you the ability to view, select, and control profiles and delivery parameters such as interval and ripple settings for appropriate weapon types. Each of these combinations is called a profile. These weapon profiles can either be selected from the DSMS page or selected as a rotary HUD selection from the HOTAS.

The DSMS provides selective jettison options and parameters for each weapon, rack, launcher, or station.

DSMS also has a set of pages used to control settings mode, power, and boresighting functions for AGM-65 and AIM-9 missiles.

DSMS Sub-Pages List

The following are the sub-pages that make up the DSMS:

- Status Page
- Profile Main Page
- Profile Control Page
- Profile Settings Page
- Inventory Main Page
- Inventory Select Page
- Inventory Class Page
- Inventory Store Type Page
- Inventory Store Select
- Selective Jettison Page
- Missile Control Page

Status Page

This is the primary page of the DSMS and is the page displayed when you first select DSMS as a page select option (OSB 12 through 15). The Status Page allows you to quickly view the following:

- Weapon inventory and status for each of the 11 stations (weapon station boxes)
- Release settings for the active profile
- Gun status and ammunition remaining
- EO power timer (if Maverick is active)
- Access to Missile, Selective Jettison, and Inventory sub-pages



Figure 211. DSMS Status Page

In the center of the page, information about the active profile is displayed. Depending on the store associated with the active profile, the content of this information may vary:

For the BOMB profile:

- All bombs including BDU, MK, GBU, CBU and any other bomb type:
- Top Line, Small Text: HUD Mode (GUNS, CCIP, CCRP, NAV, or AIR-TO-AIR)
- Second Line, Large Text Underlined: Profile Name
- Third Line, Small Text: Release Mode (SGL, PRS, RIP SGL, or RIP PRS)
- Fourth Line, Small Text: Fuze Setting (NOSE, TAIL or N/T)

- Fifth Line, Small Text: Quantity (value entered in Control page: QTY #)
- Sixth Line, Small Text: Interval in feet (value entered in Control page)
- If Release Mode is set to either SGL or PRS, then quantity and interval lines are not displayed.

For the MAVERICK profile:

- Top Line, Small Text: HUD Mode (GUNS, CCIP, CCRP, NAV, or AIR-TO-AIR)
- Second Line, Large Text Underlined: Profile Name

For the ROCKETS profile:

- Top Line, Small Text: HUD Mode (GUNS, CCIP, CCRP, NAV, or AIR-TO-AIR)
- Second Line, Large Text Underlined: Profile Name
- Third Line, Small Text: Release Mode (SGL, PRS, RIP SGL, or RIP PRS)
- Fourth Line: line is blank
- Fifth Line, Small Text: Quantity (value entered in Control page: QTY #)
- Quantity is only displayed if release mode is RIP SGL or RIP PRS

For the Illumination Flare profile:

- Top Line, Small Text: HUD Mode (GUNS, CCIP, CCRP, NAV, or AIR-TO-AIR)
- Second Line, Large Text Underlined: Profile Name
- Third Line, Small Text: Release Mode (SGL or PRS)
- The above information is derived from the DSMS Control page.

For the FUEL TANK/TRAVEL POD/LITENING POD/ALQ-131/184:

- These are not weapons, and thus do not have profiles. You cannot select these stations manually in DSMS—the magenta box highlights the OSB when pressed, but the station does not select.

If Weapons Off (WPNS OFF) is the active, live profile (Master Arm switch set to ARM), WPNS OFF is displayed in green reverse video with the HUD mode displayed above it.

If Weapons Off is the active profile and Master Arm switch is set to SAFE, WPNS OFF is displayed in white reverse video with the HUD mode displayed above it.



Figure 212. Weapons Off, SAFE

HUD modes include NAV, GUNS, CCIP, CCRP and AIR-TO-AIR.

If Weapons Off is selected as a Training Profile (Master Arm switch set to TRAIN), then the WPNS OFF message will be displayed in reverse blue video, the HUD mode will be displayed above this message, and TRAINING will be displayed in blue in a blue box below the station six station box.



Figure 213. Weapons Off, Training

OSB Functions

From the Status Page, you can access:

- **Profile (PROF) page**, branch OSB 1. Left clicking OSB 1 directs to the Profile Main page. If a Manual profile is selected, though, OSB 1 will direct to the Profile Control page.
- **Missile Control (MSL) page**, branch OSB 2. Left clicking OSB 2 directs to the Missile Control page.
- **Selective Jettison (SJET) page**, branch OSB 4.
- **Inventory (INV) main page**, branch OSB 5.
- OSB 3 selects station 6
- OSB 6 through 10 selects stations 7 through 11
- OSB 16 through 20 selects stations 1 through 5

Weapon Station Box

Next to each OSB that represents a station, a box representing what is loaded on the station is displayed. Depending on what is loaded on the station, the format of information may vary. Each such box can provide the following information depending on what is loaded on the station:



Figure 214. Weapon Station Box Fields

Station. Between the OSB and the box is a numeric of the station number. For example, OSB 6 will have a "7" between it and the station details box. For station 6, this numeric is displayed above the box. If the station has an error, this will be replaced by a letter failure code (H, I, P, or F).

Quantity. On the opposite side of the box from the OSB (towards the inner portion of the display), a smaller box is drawn that displays the quantity remaining of the weapon loaded on the station. This is removed if the station is depleted of stores or only carries a pod, rack, or launcher.

Store Type. The name of the store loaded on the station is listed on the top line.

Launcher. The type of launcher attached to the station is listed. This is generally displayed on the lower line.

Weapon Status/Laser Code. The status of the weapon loaded to the station is listed. This is generally displayed on the lower line.

Store Configuration. This is the configuration that has been set for releasing a weapon from the station.

A blank box indicates that no inventory has been loaded to the station.

For Maverick and AIM-9, the lower line will display weapon status (RDY, OFF, and ALIGN for Maverick or COOL for AIM-9)

Color-Coding of Weapon Stations and Gun

To allow you to quickly determine the status of a weapon station, a color-coding system is used for the stations and the gun. Possible colors include:

- **White.** Master Arm is set to SAFE. When in SAFE mode, all systems behave as if in ARM mode, but no weapons or flares will be released. However, if Maverick is selected, no video is shown.

- **Blue.** Master Arm is set to TRAIN. This is a simulated mode in which “virtual” weapons can be loaded on the aircraft. TRAIN profiles will not show any mismatch errors from what is in the profile and what is detected as loaded on the aircraft.
- **Green.** Master Arm is set to ARM.
- **Red.** A red indication means that the profile and the inventory have conflicting information for what is loaded on the station. Additionally, the station may be red if the weapon profile for that station has invalid settings.

The example image shows examples of each color for design purposes only. White, Blue and Green would be mutually exclusive.

The station boxes will only become color-filled when a profile has been made active that includes a weapon loaded on that station(s). Multiple stations can be color-filled if a profile is selected that includes a weapon-type loaded on multiple stations. Exceptions to this are:

- Maverick stations are only active one at a time
- Bombs with different fuze settings or types cannot be selected together
- Ordnance loaded on different types of launchers (pylon, TER, etc.) cannot be selected together

Failure Codes

In place of the Station indicator numeric between an OSB and Weapon Station Box, a letter code may be used to indicate a failure in the station. These include:

- H** This would indicate a hung store.
- I** This would indicate a mismatch between what is specified in the profile and what is set in the inventory
- P** There is no profile that contains the weapon loaded on the indicated station.
- F** This would indicate a station fault.

EO Power Timer**Figure 215. EO Power Timer**

When EO power has been activated for Mavericks, the EO Power Timer will automatically be displayed in the bottom right corner of the display. This timer will mark elapsed time in hours : minutes : seconds since the most recent Maverick activation. This timer will be removed if no Mavericks are active or EO power is set to OFF. If EO power is deactivated, the timer will be reset and the Maverick will require realignment the next time it is selected.

This timer will also be present in the following DSMS pages:

- Missile Control
- Inventory Main
- Selective Jettison

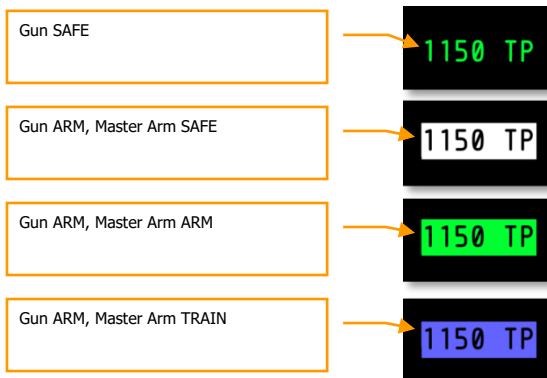
Gun Status**Figure 216. Gun Status Indications**

Located below the Weapon Mode Summary on the Status page, the gun status is displayed. The status lists the number of rounds remaining in the left portion of the display and the selected

ammunition type to the right. Depending on the settings of the GUN/PAC switch on the AHCP and the Master Arm switch on the AHCP, the color and reverse video status varies.

The gun defaults to a load of 1,150 rounds and when the gun is fired, the ammunition count decrements in 10s. This is true for ARM and TRAIN modes.

Note: When in TRAIN mode, there is no way to reset the gun.

If the GUN/PAC switch is set to other than SAFE, setting the Master Arm to:

- **ARM** results in green reverse video.
- **SAFE** results in white reverse video.
- **TRAIN** results in blue reverse video.

If, however, the GUN/PAC switch is in SAFE, the gun field on the Status page will be green text (no reverse video).

- Maverick stations are only active one at a time
- Bombs with different fuze settings or types cannot be selected together
- Ordnance loaded on different types of launchers (pylon, TER, etc.) cannot be selected together

From the Profile Main page, you can access/create up to 20 active (ARM/SAFE) profiles and 20 (TRAIN) profiles. Depending on the setting of the Master Arm switch, the profiles will change.

To select a profile for weapon delivery use, you can do so in five ways:

- HUD rotary selection from the HOTAS
- Select (SEL) +/- rocker switch on the UFC
- From the Profile Main page, select the Activate Profile (ACT PRO) OSB
- From the Status Page, manually select a weapon station by pressing the OSB next to it (MANUAL)
- The Air-to-Air profile is automatically selected when Air-to-Air HUD mode is selected:
 - If GUNS, CCIP, CCRP, or NAV, is commanded, the previous profile will be reverted to from Air-to-Air.
 - The previous profile will be reverted to if Air-to-Air master mode is deselected.
 - If the prior mode was MANUAL, the profile would revert to WPNS OFF profile.

In addition to these 40 profiles, three other profile options are available:

MANUAL Profile

The MANUAL profile provides a quick way of selecting a weapon and generating a profile. The MANUAL profile can be invoked by selecting a weapon station on the Status page. The profile name then becomes "M/store type" and the default parameters for the selected store type are loaded as the active release profile. If another weapon station with matching weapon type is selected, this station is added as a selected station. If another station with a different weapon type is selected, the profile name changes to "M/store type" of that weapon and the default parameters for the selected store type are loaded as the active release profile.

IMPORTANT: When you create a Manual Profile, you cannot save changes to the Manual Profile setting!

When a MANUAL profile is active, depressing the PROF OSB on the Status page will instead go to the Control page. On the Control page, the OSB 19 and 20 Navigation functions are disabled and removed. From the Control page, changes to the default parameters can be made. Any changes though result in the SAVE OSB being displayed and flashing. You must press the SAVE OSB to make any changes active. If the name of the MANUAL profile is changed with the NEW OSB and then saved with the SAVE OSB, a new profile is created and added to the profile list. If there are already 20

active profiles, then the NEW OSB is removed from the Manual Profile display. If you select a different profile from the profile list, the navigation OSBs will be displayed again.

MANUAL mode is not available as a HUD rotary nor is it listed on the Profile Main list.

Profile Main Page OSB Functions



Figure 218. Profile Delete Confirmation

From the Profile Main page, you can access:

Return to DSMS Status (STAT) page, branch OSB 1. Left clicking OSB 1 returns to the DSMS status page.

View profile control page (VIEW PRO) page, system action OSB 3. Left clicking OSB 3 directs to the Profile Control nested page. Upon doing so, the control page of the selected profile will be displayed.

Clear profile (CLR PRO) page, system action OSB 5. Left clicking OSB 5 deletes the selected profile. Upon doing so, a confirmation prompt is displayed. You must then press OSB 5 a second time within 3 seconds to confirm the deletion. If not, the confirmation window will be removed, and the profile will be unchanged.

Move profile in list (MOVE), navigation OSBs 6 and 7. Left clicking these two navigation OSBs allows you to re-order the selected profile in the profile list.

Clicking the UP navigation arrow swaps the selected profile with the one above it. If the selected profile is at the top of the list, the UP navigation will have no effect.

Clicking the DOWN navigation arrow swaps the selected profile with the one under it. If the selected profile is at the bottom of the list, the DOWN navigation will have no effect.

Place profile On/Off HUD (PRO ON/OFF), rotary OSB 9. Left clicking rotary OSB 9 enables the selected profile to be added or removed from the HUD rotary.

If the profile has been set to be a HUD rotary selection (indicated as ON in the profile table list), this OSB function will be set to ON (PRO ON).

If the profile has not been set to be a HUD rotary selection (indicated as OFF in the profile table list), this OSB function will be set to OFF (PRO OFF).

If the weapon in the profile is not in the loaded inventory, the HUD rotary and the OSB 9 label is replaced with "----". However, this will not be displayed until a new profile is selected.

Make selected profile active (ACT PRO), system action OSB 17. Left clicking OSB 17 makes the selected profile active. This function will not make the selected profile active unless the profile is set as a HUD rotary selection. If the selected profile is already the active profile, this function is not displayed and the OSB is inactive.

Scroll profiles (Profile Name), navigation OSBs 19 and 20. Left clicking on these two OSBs moves the arrow to the left of the profile list up and down. The profile that the arrow is pointing to is the selected profile. By default, the active profile is first selected. Additionally, the profile name between the two navigation arrows will cycle through the profile list as arranged on the Profile Main page.

Profile Table

Dominating the center of the Profile Main page is the profile table. It is here that all profiles are listed and you may re-order them, select them, activate them, and remove them; all from the table.

Each profile in the table is assigned a row and each contains the following information:

- Profile name
- Name of associated weapon
- Rotary status. If profile is assigned to the HUD rotary it is indicated as ON; if not, it is indicated as OFF. If the profile requires a weapon that is not in the loaded inventory, "---" is indicated.

The active profile will be listed in reverse video and the color will depend on the Master Arm setting.

- **ARM** = Green
- **TRAIN** = Blue
- **SAFE** = White

If, however, MANUAL or AIR-AIR is selected as the active profile, it will be listed above the table and according to the color specification of the Master Arm switch.

If an invalid profile is selected (such as the weapon in the profile not matching the loaded inventory), the profile entry will be listed in red reverse video. This is true for ARM and SAFE modes but not TRAIN mode.

Profile Control Page

After a profile has been selected to be viewed from the VIEW PRO OSB 3, you will be directed to the Profile Control page. This page provides you the ability to adjust the weapon settings associated with the selected profile. This can be done with the OSBs along the right and left sides of the display. In the center of the display the profile table is displayed but data within the table cannot be modified from this page.

Profile Parameters Table and Station Chart

In the center of the Profile Control and Profile Settings pages is a table that lists release parameters for the active profile weapon (both pages show the same table). Parameters that are not underlined can only be adjusted from the Inventory Page. Depending on the store type selected, the fields within the table will vary.

In the top portion of the table are two lines. The top line indicates the weapon associated with the selected profile and on the second line "PROFILE CONTROL" is listed.

If the Master Arm switch is set to TRAIN, "TRAIN" will be listed in blue within a blue box centered on top of the table.

If a weapon specified in a profile is not present in the loaded inventory, then all parameters in the table will be listed as "---".

If a data value is entered that is invalid for the weapon, an error indication will be shown in two ways:

- The active profile name (OSB 19 and 20) will have its label shown in red reverse video
- Invalid parameters within the Parameter Table will be displayed in red reverse video.

If the listed profile name (OSB 19 and 20) is also the active profile, then the name will be listed in reverse video. The color of the reverse video will depend on the setting of the Master Arm switch: Green = ARM, Blue = TRAIN, and White = SAFE.

Below the table is a horizontal chart of 11 equal sections. Each of these sections represents one of the aircraft's weapon stations (1 to 11 from left to right). Inside each of these sections, the weapon station number is indicated as a numeric. When a profile is selected, all weapon stations that share the same weapon or store in the profile will be selected/highlighted.



Figure 219. DSMS Profile Control Page

Profile Control Page OSB Functions

From the Profile Control page, you can access the following functions:

Return to DSMS Status page (STAT) page, branch OSB 1. Left clicking OSB 1 returns to the DSMS status page.

Return to Profile Main (PROF MAIN) page, OSB 2. Left clicking this OSB will direct back to the Profile Main page.

Save (SAVE) profile parameter settings, system action OSB 3. Left clicking this OSB will save the Profile Control and Settings parameters of the currently displayed profile. This function will only be available if a setting to the profile has been modified or the name (using the NEW function) has been changed. When active, the SAVE OSB label flashes.

Change Profile Settings (CHG SET) page, branch OSB 16. Selecting this OSB displays the Change Profile Settings page. However, if the active profile does not have a Profile Settings page, this branch OSB will not be displayed.

New Profile Name (NEW), data entry OSB 18. Using either the UFC or CDU keypads, you may enter an alphanumeric name for the profile prior to saving. When the new name is entered, it will replace the "NEW" label until the SAVE function is activated. If you enter a profile name that already exists or is longer than 8 characters, the scratchpad will display an error message of "CICU INPUT ERROR." If a new profile name is a duplicate of an existing one, it will be colored red and the SAVE function will be disabled. If there are already 20 active profiles when viewing a current profile, the NEW OSB is displayed so the profile name can be changed (but not add a new profile).

Scroll profiles (Profile Name), navigation OSBs 19 and 20. Left clicking on these two OSBs moves the arrow to the left of the profile list up and down. The profile that the arrow is pointing to is the selected profile. By default, the active profile is first selected. Additionally, the profile name between the two navigation arrows will cycle through the profile list as arranged on the Profile Main page. The WPNS OFF profile cannot be selected and will be skipped over.

The active profile name is displayed on the HUD when the profile is selected.

In addition to these default OSB functions that are displayed on the Profile Control page regardless of the selected store profile, the functions OSB 6 through 10 can vary according to the selected store profile.

MODE. Select HUD mode of CCIP or CCRP

QTY. Quantity per release

SGL/PRS/RIP SGL/RIP PRS. Release modes of Single, Pairs, Ripple Singles, and Ripple Pairs

FT. Release spacing interval

NOSE/TAIL/N/T. Fuze settings of Nose, Tail and Nose/Tail. For MK82AIR bomb, fuze must be set to TAIL or N/T for high-drag delivery. Setting fuze to NOSE will deliver bomb in low drag configuration. This setting is particularly important for the MK82AIR as it determines high or low drag release.

Note: if using Mk-82AIR in high drag mode (fuze set to N/T or TAIL), the CONFIG should be set to FIXED HI. If you wish to release a Mk-82AIR in low drag mode (fuze set to nose), the CONFIG should be set to FIXED LO. A new profile will need to be created for a new CONFIG. The CONFIG is set in the DSMS Inventory pages.

To create a Mk-82AIR low drag delivery profile:

1. From DSMS Inventory, set Mk-82AIR to FIXED LO.
2. From DSMS Status page, manually select a Mk-82AIR station.
3. Create a new profile name and select NEW from the DSMS Profile page.
4. Set this profile for NOSE fuze.

Modifying and Creating a Profile

Whether you are modifying a profile or creating a new one, the first step is to select an existing profile. From either the Profile Control page or the Profile Settings page, you may change settings data and save it under the same name (modifying a profile) or saving the modified profile under a new name (creating a profile).

Once any changes have been made to a profile, the SAVE function (OSB 3) becomes active. When active, the SAVE OSB label flashes. If activated, the SAVE function will save all changes made on both the Control and Settings Profile pages. If the newly saved profile is also the active profile, the changes will take effect immediately and be reflected on the HUD and MFCD.

If all 20 live profiles are occupied, the user must delete an existing profile to create a new one. The same holds true for training profiles.

Please consult the Combat Employment chapter for additional details.

Profile Settings Page

The Profile Settings page is very similar to the Profile Control page but allows you to edit table settings.



Figure 220. DSMS Profile Settings Page

Within the table, several items are underlined. These indicate items that may be adjusted from the Profile Settings page. Because different weapons will have different setting requirements, the OSB settings will vary between stores.

As discussed above, OSB functions other than 1, 2, 3 and 20 may vary according to the store selected from the Store Cycle 20 OSB. These page variants include:

- **AUTO LS.** Allows the laser to automatically fire according to the LS TIME value
- **DES TOF.** Desired time of fall
- **DRAG.** No function
- **EJECT.** Ejection velocity in ft/second
- **HD TOF.** High drag time of fall in seconds. This value determines the behavior of the Desired Release Cue (DRC) on the HUD for CCIP and CCRP bomb delivery. When set to 0, no DRC is displayed.
- **HOT.** Desired height over target at mid-burn

- **LD TOF.** Low drag time of fall in seconds. This value determines the behavior of the Desired Release Cue (DRC) on the HUD for CCIP and CCRP bomb delivery. When set to 0, no DRC is displayed.
- **LS TIME.** The time in seconds before bomb impact that the laser will turn on. AUTO LS must be set to ON.
- **MIN ALT.** Minimum altitude in feet. This value determines the behavior of the Minimum Range Staple (MRS) on the HUD for CCIP and CCRP bomb delivery. When set to 0, no MRS is displayed.
- **RACK.** Rack delay in seconds
- **RT.** Lateral offset in Mils
- **SEM.** Release maneuver of NONE, CLM, TRN or TLT
- **SOLN.** LGB solution
- **UP.** Vertical offset in Mils
- **HOF.** Height of function that a cluster bomb will open

Please consult the Combat Employment chapter for additional details.

Profile Settings Page OSB Functions

At the top of the page, the following OSBs are located:

Return to DSMS Status page (STAT) page, branch OSB 1. Left clicking OSB 1 directs to the DSMS Status page.

Return to Profile Control Page (RET) page, OSB 2. Left clicking this OSB will direct back to the Profile Control page.

Save (SAVE) profile parameter settings, system action OSB 3. Left clicking this OSB will save the Control and Settings parameters of the currently displayed profile. This function will only be available if a setting to the profile has been modified or the name (using the NEW function) has been changed. When active, the SAVE OSB label flashes at 1 Hz.

Inventory Sub-Page

The primary function of the Inventory page is to allow you to assign a particular weapon to a specified weapon station. This allows you to correct an error when the weapon type does not match the one specified in the profile and it allows you to set additional weapon settings not available in the Profile Settings page. It also allows you to create "virtual" payloads in training mode.

The Inventory page is accessed by pressing OSB 5 (INV) on the Status page.



Figure 221. DSMS Main Inventory Page

The Inventory function provides a logical progression through the loading of weapons onto the aircraft. Selections are made on successive pages, which progressively narrow the allowable selections based on stores sensed, allowable configurations, and other pertinent information. The page progression order is **Inventory Main** → **Store Class** → **Store Type** → **Store Settings**.

Inventory Main Page

The Inventory Main page displays the same inventory as shown on the Status page for each weapon station. The profile information and gun status information in the center of the display is removed and replaced with "INVENTORY." After a weapon station is selected from the Inventory Main page by selecting the OSB next to the station, the Inventory Select page is displayed.

If Maverick has had its EO power activated, the EO Power Timer will be displayed in the bottom right of the display.

If in Training mode, "TRAINING" will be blue boxed below the INVENTORY page title.



Figure 222. DSMS Inventory Page – Empty

Inventory Main Page OSB Functions

Return to DSMS Status page (STAT) page, branch OSB 1. Left clicking OSB 1 directs to the DSMS Status page.

- OSB 3 selects station 6
- OSB 6 through 10 selects stations 7 through 11
- OSB 16 through 20 selects stations 1 through 5

Inventory Store Class Page

After a weapon station has been selected from the Inventory Main page, the Inventory Store Class page is displayed. This page allows you to select the class of store that is to be loaded on the selected weapon station. The available classes of stores listed will depend on the station selected (not all stations can be loaded with all classes of stores). Because not all stores within a store class may be loaded onto a specified station, the list of stores within a class may vary as well. Below is a chart showing possible store loading:

STORES	1	2	3	4	5	6	7	8	9	10	11
BOMB - CLASS	X	X	X	X	X	X	X	X	X	X	X
MK82, MK82A, BDU50	X	X	X	X	X	X	X	X	X	X	X
MK84, BDU56			X	X	X	X	X	X	X		
BDU33			X	X	X	X	X	X	X		
CBU - CLASS	X	X	X	X	X	X	X	X	X	X	X
CBU87	X	X	X	X	X	X	X	X	X	X	X
CBU-103			X	X	X		X	X	X		
GBU - CLASS	X	X	X	X	X	X	X	X	X	X	X
GBU-10			X	X	X	X	X	X	X		
GBU-12	X	X	X	X	X	X	X	X	X	X	X
GBU-31			X	X	X		X	X	X		
GBU-38			X	X	X		X	X	X		
MISC - CLASS			X	X	X	X	X	X	X		
CTU2A			X					X	X		
TK600 (FUEL TANKS)				X		X		X			
TRAVEL POD			X	X	X	X	X	X	X		
ROCKET - CLASS		X	X	X				X	X	X	
M257, M278		X	X	X				X	X	X	
MK1, MK5, MK61		X	X	X				X	X	X	

STORES	1	2	3	4	5	6	7	8	9	10	11
APKWS		X	X	X				X	X	X	
M151, M156, WTU1B, M274		X	X	X				X	X	X	
FLARE - CLASS		X	X						X	X	
LUU156		X	X						X	X	
LUU2 (/B, A/B, B/B)		X	X						X	X	
LUU19B		X	X						X	X	
MISSILE - CLASS	X		X						X		X
AIM-9, CATM-9	X										X
AGM-65 (D, G, G2, H, K, L)			X						X		
POD - CLASS	X	X								X	X
LITENING AT		X								X	
ALQ131	X										X
ALQ184	X										X
RACK - CLASS	X	X	X	X	X	X	X	X	X	X	X
PYLON	X	X	X	X	X	X	X	X	X	X	X
TER (TRIPLE EJECTOR RACK)			X	X	X	X	X	X	X		
LAU117			X						X		
LAU88			X						X		
SUU25		X	X						X	X	
DRA 2 LAU105	X										X
LAU68		X	X	X				X	X	X	
LAU131		X	X	X				X	X	X	

Table. A-10C Loading Chart

In the center of the page, the station number is listed and underlined; for example: STA 10. Below the station number is the current inventory of the station.



Figure 223. DSMS Inventory Store Class Page

Below the current inventory information, the type of inventory that has been detected is displayed. When the displayed data does not match the current inventory information listed above it, the detected inventory text is displayed in red reverse video and "CHECK LOADOUT" is displayed underneath it in red reverse video. Additionally, if invalid inventory settings are created for the selected station, then the detected inventory will be listed in red reverse video and underneath it "CHECK SETTINGS" will be displayed in red reverse video.

If in Training mode, "TRAINING" will be blue boxed below the INVENTORY SELECT page title.

Possible detected inventory messages include:

DETECTED INVENTORY MESSAGE	CONDITION
LITENING POD DETECTED	Litening target pod detected on station

DETECTED INVENTORY MESSAGE	CONDITION
MAVERICK DETECTED	Maverick missile detected on station
MAV LAU DETECTED	LAU-88 or LAU-117 detected, but no Maverick loaded. (Not possible in Phase 1.)
TER DETECTED	Triple Ejector Rack detected. Message only shown when Master Arm set to ARM and station selected. Or, station selected and selective jettison in STR mode. (Not possible in Phase 1.)
EMPTY	No store detected on station. This will also be shown for AIM-9 and ECM pods.
STORE DETECTED	Displayed if any store or launcher is detected that is not listed above. Will also be shown if TER is detected while Master Arm is set to SAFE. If no station is selected, this will also be displayed.

Inventory Select Page OSB Functions

Return to DSMS Status (STAT) page, branch OSB 1. Left clicking OSB 1 directs to the DSMS Status page.

Return to Inventory Main (RET) page, branch OSB 2. Left clicking this OSB returns the display to the Inventory Main page.

Inventory Status (INV STAT), system action OSB 3. Left clicking this OSB displays the Store Inventory page for the selected store currently selected for the active station. This bypasses the steps for selecting class and store type. If no store is loaded on the selected station, this function is not available (OSB does not function, and label is not shown).

TER Re-Homing (HOME TER), system action OSB 4. If no TER is on the selected station this label does not appear and the OSB is non-functional.

Station Clearing (CLR STA), system action OSB 5. Left clicking on this OSB will remove all store assignments to the selected station. This action will also automatically direct to the Inventory Main page.

BOMB, branch OSB 6. Left clicking this OSB will direct to the Bomb Select page.

CBU, branch OSB 7. Left clicking this OSB will direct to the CBU Select page.

GBU, branch OSB 8. Left clicking this OSB will direct to the GBU Select page.

MISC, branch OSB 9. Left clicking this OSB will direct to the Misc. Stores page.

ROCKET, branch OSB 16. Left clicking this OSB will direct to the Rocket Select page.

FLARE, branch OSB 17. Left clicking this OSB will direct to the Flare Select page.

MISSILE, branch OSB 18. Left clicking this OSB will direct to the Missile Select page.

POD, branch OSB 19. Left clicking this OSB directs to the POD Select page.

RACK, branch OSB 20. Left clicking this OSB directs to the Rack Select page.

Depending on the station, only certain store class types will be available from the Inventory Class Select page. Classes that are not available for a selected station will be unavailable (OSB will have no function and label will be removed). The following table lists allowable store classes and specific stores allowed for each of the 11 stations.

Station 6 must be empty to load stores on stations 5 and 7.

Stations 5 and 7 must be empty to load station 6.

A TER can be loaded on stations 5, 6 and 7 with or without BDU33 loaded.

Another means to visualize the compatibility between a store class and a station is shown in the table below. When the listed Weapon Station is selected, only the store classes listed to the right will be displayed on the Inventory Select page.

WEAPON STATION	COMPATIBLE STORE CLASSES
1	BOMB, CBU, GBU, MISSILE, POD, RACK
2	BOMB, CBU, GBU, ROCKET, FLARE, POD, RACK
3	BOMB, CBU, GBU, MISC, ROCKET, FLARE, MISSILE, RACK
4	BOMB, CBU, GBU, MISC, ROCKET, RACK
5	BOMB, CBU, GBU, MISC, RACK
6	BOMB, CBU, GBU, MISC, RACK
7	BOMB, CBU, GBU, MISC, RACK
8	BOMB, CBU, GBU, MISC, ROCKET, RACK
9	BOMB, CBU, GBU, MISC, ROCKET, FLARE, MISSILE, RACK
10	BOMB, CBU, GBU, ROCKET, FLARE, POD, RACK
11	BOMB, CBU, GBU, MISSILE, POD, RACK

Table. Store Class to Station

Because each station may have variation of the store classes that can be loaded, and even the specific stores within a class may vary, the tables shown below provide a guide to what is allowable per station. When a class of weapon is selected for a station, the page title will change to reflect the store class. For example:

BOMB
INVENTORY

INVENTORY Store Type Page

Once a Store Class has been selected for a station, you will be directed to the Inventory Store Type page that lists all the store types of the selected class that can be loaded on the selected station. According to the station selected, the store types of each class may vary. What follows is a listing of the classes of each station and the store types possible for each of the classes:

CLASS	STATION 1 AND 11	STATION 2 AND 10	STATION 3 AND 9	STATION 4 AND 8	STATION 5 AND 7	STATION 6
BOMB	MK-82	MK-82	MK-82	MK-82	MK-82	MK-82
	MK-82AIR	MK-82AIR	MK-82AIR	MK-82AIR	MK-82AIR	MK-82AIR
	BDU-50	BDU-50	MK-84	MK-84	MK-84	MK-84

CLASS	STATION 1 AND 11	STATION 2 AND 10	STATION 3 AND 9	STATION 4 AND 8	STATION 5 AND 7	STATION 6
			BDU-33	BDU-33	BDU-33	BDU-33
			BDU-50	BDU-50	BDU-50	BDU-50
			BDU-56	BDU-56	BDU-56	BDU-56
CBU	CBU-87	CBU-87	CBU-87	CBU-87	CBU-87	CBU-87
			CBU-103	CBU-103	CBU-103	CBU-103
GBU	GBU-12	GBU-12	GBU-10	GBU-10	GBU-10	GBU-10
			GBU-12	GBU-12	GBU-12	GBU-12
			GBU-31	GBU-31	GBU-31	GBU-31
			GBU-38	GBU-38	GBU-38	GBU-38
			BDU-56L	BDU-56L	BDU-56L	BDU-56L
ROCKET		M-257	M-257	M-257		
		M-278	M-278	M-278		
		MK-1	MK-1	MK-1		
		MK-5	MK-5	MK-5		
		MK-61	MK-61	MK-61		
		M-151	M-151	M-151		
		M-156	M-156	M-156		
		M-272	M-272	M-272		
		WTU-1B	WTU-1B	WTU-1B		
		APKWS	APKWS	APKWS		
FLARE		LUU-2B/B	LUU-2B/B			
MISSILE	AIM-9		AGM-65D			
	CATM-9		AGM-65G			
			AGM-65H			
			AGM-65K			
			AGM-65L			
			CATM-65K			
			TGM-65D			

CLASS	STATION 1 AND 11	STATION 2 AND 10	STATION 3 AND 9	STATION 4 AND 8	STATION 5 AND 7	STATION 6
			TGM-65G			
			TGM-65H			
POD	ALQ-131	Litening AT				
	ALQ-184					
RACK	LAU-105	LAU-68	LAU-68	LAU-68	TER	TER
		LAU-131	LAU-131	LAU-131		
		SUU-25	SUU-25	TER		
			LAU-117			
			LAU-88			
MISC			CTU-2A	CTU-2A	CTU-2A	CTU-2A
				TK600	TK600	TK600

Inventory Store Page

After you have selected an available store from the Inventory Type page, the Store page is displayed. After the store has been selected, parameters may be set using the OSB controls. Depending on the selected store, these setting parameters will vary. However, all Store pages have the following functions in common:

Return to DSMS Status (STAT) page, branch OSB 1. Left clicking OSB 1 directs to the DSMS Status page.

Return to Class Select (RET) page, branch OSB 2. Left clicking this OSB returns the display to the Inventory Select page.

Save (SAVE) profile parameter settings, system action OSB 3. Left clicking this OSB will save the parameters of the currently displayed station. This function will only be available if a setting to the station has been modified. When active, the SAVE OSB label flashes at 1 Hz.



Figure 224. DSMS Inventory Store Page

In the center of the display, several items are listed. From top to bottom:

The name of the store inventory is listed as two lines. The first line is the store class name and the second reading INVENTORY. For example:

ROCKET
INVENTORY

If the Master Arm is set to ARM, ARM will be boxed in green. If the Master Arm is set to TRAIN, TRAINING will be boxed in blue, and if the Master Arm is set to SAFE, SAFE will be boxed in white.

The selected station number will be listed underlined as STA (station number). For example: STA 9

The name of the store currently assigned to the station.

The specific store options vary between store types, but the general rules apply:

OSB 1 to OSB 5

- **OSB 1. STAT.** Return to the main DSMS Status page.
- **OSB 2. RET.** Return to the previous page.
- **OSB 5. QTY.** Select the number of store of the type on the station.

OSB 6 to OSB 10

- **OSB 6. MNT.** This field generally controls how the store is mounted on the station. This can either be TER or PYLON.
- **OSB 7. LSR CODE.** For laser-guided bombs, the laser code for the store is entered here. You will want to ensure that this code matches the laser code from the TGP A-G Control Page.
- **OSB 8. CONFIG.** Some bombs like the Mk-82AIR and BDU-50HD have the option for both high-drag and low-drag delivery. These settings allow different fuze configurations to be used depending on the selected CONFIG option (FIXED HI, FIXED LO, etc.). For high drag mode, FIXED HI should be used; and for low drag mode, FIXED LO should be used. Possible CONFIG options include:
 - LDGP
 - FLB
 - FIXED HI
 - FIXED LO
 - PLT OPT
 - PLT OPT1
 - PLT OPT2
- **OSB 9. LOAD.** Saves and loads the store selection to the station.
- **OSB 10. LOAD SYM.** Loads the selected and configured store to the corresponding station on the other wing.

OSB 16 to OSB 20

Nose and tail fuze types and nose and tail fuze settings are listed on between OSB 16 and 20 generally. If a fuze setting or choice is invalid, it will be highlighted in yellow.

For CBU weapons, OSB 17 and 18 allow setting of spin RPM and Height of Function (HOF).

Some bombs, particularly laser-guided bombs, have multiple series, and the specific series can be set from OSB 16.

For rockets, OSB 20 allows you to select the warhead type.

Inventory Page Common Uses

In addition to using DSMS Inventory to create virtual Training payloads, the other two most common uses for these pages are to clear hung station errors and setting the burst height for cluster bombs.

Clear Hung Station. This is a common error when the pilot does not hold down the weapon release button long enough when dropping a bomb. This warning and ability to use the weapon is resolved by reloading the hung station. This is done by:

1. Press DSMS INV (OSB 5)
2. Press the OSB (1 - 11) that corresponds to the hung station.
3. Press the OSB that corresponds to the store class of the hung weapon.
4. Press the OSB that corresponds to the type of hung weapon.
5. On the store page, press LOAD (OSB 9) to reload the station.
6. Press STAT (OSB 1) to return to the main DSMS page.

***Note:** After clearing a hung IAM loaded store, you will then need to reset the power to the station in the STAT page and then reload ALL from the DTS page to make the weapon functional again.*

CBU Dispersal Area. From the Inventory pages, you can also set the area that you want the CBU bomblets to cover (aka the footprint). Higher values for HOF altitude and RPM spin result in a larger bomblet footprint, but less dense coverage. The steps to set this are:

1. Press DSMS INV (OSB 5)
2. Press the OSB (1 - 11) that corresponds to the CBU station you want to set.
3. Press the CBU OSB.
4. Press the OSB that corresponds to the type of CBU that you wish to adjust.
5. From the HOF (Height of Function) OSB 18, select the desired burst altitude. The greater the value, the greater the dispersal.
6. From the RPM OSB 17, select the desired spin setting. The greater the value, the greater the dispersal.
7. On the store page, press LOAD (OSB 9) to save your changes.
8. Press STAT (OSB 1) to return to the main DSMS page.

Selective Jettison Sub-Page

Accessed from OSB 4 on the Status page, this page is similar in appearance to the Inventory Main page but allows you to select a weapons station with the associated OSB and jettison it. Weapon release is accomplished by depressing the **weapon release button**.

Selection of stations for jettison is independent of station selection on the Weapon Status page.

Each station lists the store assigned to it, and this store will be highlighted (depending on the jettison mode) according to the Master Arm setting and fuze setting.

- White reverse video if Master Arm switch set to SAFE
- Green reverse video if Master Arm switch set to ARM and fuze setting is not in SAFE mode
- Green reverse video flashing at 1 Hz if Master Arm switch set to ARM and fuze setting is set to SAFE mode
- Blue reverse video if Master Arm switch is set to TRAIN and fuze is set to other than SAFE
- Blue reverse video flashing at 1 Hz if Master Arm switch is set to TRAIN and fuze setting is set to SAFE



Figure 225. DSMS Selective Jettison Page

Selective Jettison Page OSB Functions:

- **Return to DSMS Status (STAT) page**, branch OSB 1. Left clicking OSB 1 directs to the DSMS Status page.

- **Weapon Fuze Select (XXXX)**, rotary OSB 4. Cycling this rotary displays four settings and the selected setting becomes the OSB label. Settings are:
 - SAFE (safe)
 - NOSE (nose arm)
 - TAIL (tail arm)
 - N/T (nose – tail arm)

These fuze options are only available when the Jettison Mode is set to STR (stores). If set to other than STR, the fuze select will be set to SAFE and cannot be altered.

Below the SELECTIVE JETTISON page title, a textual indication is provided regarding the fuze setting:

- SAFE is displayed in green if the Safe fuze setting is selected
- NOSE ARM is displayed in red if the Nose fuze setting is selected
- TAIL ARM is displayed in red if the Tail fuze setting is selected
- ARMED is displayed in red if the N/T fuze setting is selected
- **Jettison Mode (XXXX)**, rotary OSB 5. Left clicking this OSB cycles through the jettison modes and the selected mode is displayed as the OSB label. Modes include:
 - **STR** (store). When in STR mode, the user can jettison stores from one or more selected stations. Stores are released in pairs mode.
 - **RACK** (station rack). When in RACK mode, the user can select one or multiple stations that have racks assigned to them and jettison them along with any stores attached to them. If more than one station is selected that is assigned a rack, then they are released in paired mode. A rack, or pair of racks, is jettisoned with each press of the **weapon release button**.
 - **MSL** (missile). In this mode, any Maverick assigned to a LAU-88 TER will be launched in an unguided/unarmed mode with each depression of the **weapon release button**. If both TERs are selected, Mavericks will be launched in pairs. MSL jettison is not available for LAU-117. If a station is selected that is not loaded with LAU-88 and Maverick, only the station number will be displayed in reverse video.

To select a station to jettison, the user left clicks on the OSB next to the station to be jettisoned. Multiple stations can be selected simultaneously. When a station is selected, its store name is displayed in reverse video.

In the lower right corner of the display, the EO Power timer is displayed when EO power has been applied to Maverick.

Note: The Targeting Pod and ECM pod cannot be jettisoned.

Missile Control Sub-Page

Accessed from (MSL) OSB 2 of the Weapon Status page, this page controls the settings for the AIM-9 and AGM/TGM-65.

In the top center of the page, the page title is displayed as: MISSILE CONTROL

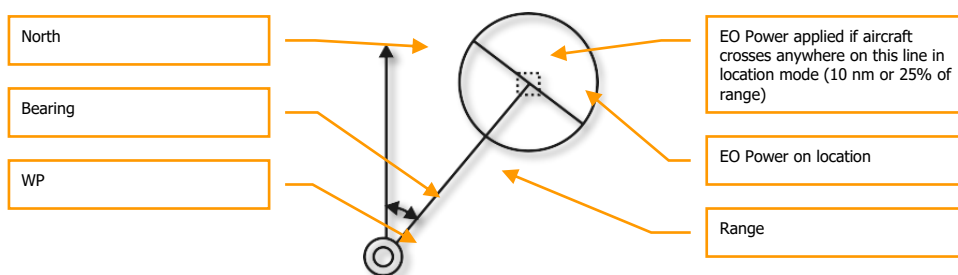

Figure 226. DSMS Missile Control Page

Missile Control Page OSB Functions:

- **Return to DSMS Status (STAT) page**, branch OSB 1. Left clicking OSB 1 directs to the DSMS Status page.
- **EO Power (EO)**, rotary OSB 4. This OSB allows you to manually apply power to all Mavericks loaded on the aircraft. Left clicking on this OSB cycles between the ON and OFF settings. If OFF is selected, all Mavericks are powered down. Upon setting EO power to ON, the EO Power timer will be displayed. If EO power is set to OFF, the timer is removed from the page. EO power can also be automatically activated according to the setting of the automatic EO power function accessed from OSB 5.

- **Automatic EO Power Function (XXX)**, rotary OSB 5. Using the OSB 5 rotary function, you can cycle through the automatic EO power functions, including:
 - **Location (LOC)**. EO power will be activated when the aircraft reaches specified range (OSB 8) and bearing (OSB 7) from a defined waypoint (OSB 9). The system will activate EO power to the Maverick(s) when the aircraft crosses the defined point. A five-mile radius line expands from this point perpendicular to the defined waypoint and crossing this line will activate EO power. See diagram.



- **Time (TIME)**. When OSB 5 is set to the TIME function, EO power will automatically be applied when the time specified by OSB 10 is reached.
 - **Manual (MAN)**. Using OSB 4, the user can turn EO power ON and OFF manually by cycling this rotary when MAN is selected.
- **Maverick Boresight Adjust (MAV ADJ)**, rotary OSB 6. This rotary is used to boresight the Maverick HUD reticle. Settings include ON and OFF. Please see Maverick section of this document for details.
 - **Auto EO Power Bearing (BRG)**, data entry OSB 7. Using this OSB, you may enter the bearing to the EO activation point from a defined waypoint. Below the BRG label, the bearing is indicated using three numbers. The bearing value can range from 0 to 359 and can be incremented by 1.
 - **Auto EO Power Range (RNG)**, data entry OSB 8. Using this OSB, you may enter the range to the EO activation point from a defined waypoint. Below the RNG label, the range is indicated using three numbers. The range value can range from 0 to 9999 and can be incremented by 1.
 - **Auto EO Power Waypoint (WYPT)**, plus/minus waypoint OSB 9. Using the plus and minus waypoint function, you can cycle through waypoint numbers. The selected waypoint's number will be displayed below the WYPT label. Additionally, using the UFC or CDU keypad, you may enter the waypoint number to select it.

- **Time EO Power (TIME)**, data entry OSB 10. This data entry OSB function allows you to enter the hour: minute: second that EO power will be applied to the Maverick if Automatic EO Power Function has been set to TIME. The time is related to the aircraft system time. If the Automatic function is set to other than TIME, this label is not displayed and the OSB has no data entry function.
- **AIM-9 Control (AIM9)**, rotary OSB 19. Rotary selections include OFF, COOL, SEL. The selected rotary setting is displayed beneath the AIM9 label. There are no other functions. Selecting SEL places HUD in air-to-air mode.
- **AIM-9 Boresight (AIM9 ADJ)**, rotary OSB 20. Rotary selections include ON and OFF. The selected rotary setting is displayed beneath the AIM9 ADJ label. There are no other functions.

Tactical Awareness Display (TAD) Page

The TAD displays a plan-view of your current tactical situation with the symbols representing your aircraft position (Ownship), the Sensor Point of Interest (SPI), the Anchor Point/ Bullseye, current steerpoint, active markpoint, datalink symbols, or active flight plan with waypoints, and range rings. The TAD can be a Sensor of Interest (SOI) which can be used to designate the SPI using a cursor that is controlled by the HOTAS allowing the pilot to hook symbols on the display.

A moving map with different scales can also be displayed. This map has multiple scales with each scale using a different air navigation chart type.

The TAD page is accessed by either pressing a page select OSB with the TAD label or using the HOTAS to cycle MFCD pages.

On the TAD, a slewable cursor is displayed that can be commanded with the HOTAS slew functions when the TAD page is the SOI. The cursor is your means to select objects/symbols on the TAD.

MFCD Commands:

ADJ rocker up (+): When in manual map mode (MAN), this zooms the moving map in one level while retaining the current air navigation chart type.

ADJ rocker down (-): When in manual map mode (MAN), this zooms the moving map out one level while retaining the current air navigation chart type.

Basic TAD Symbolology

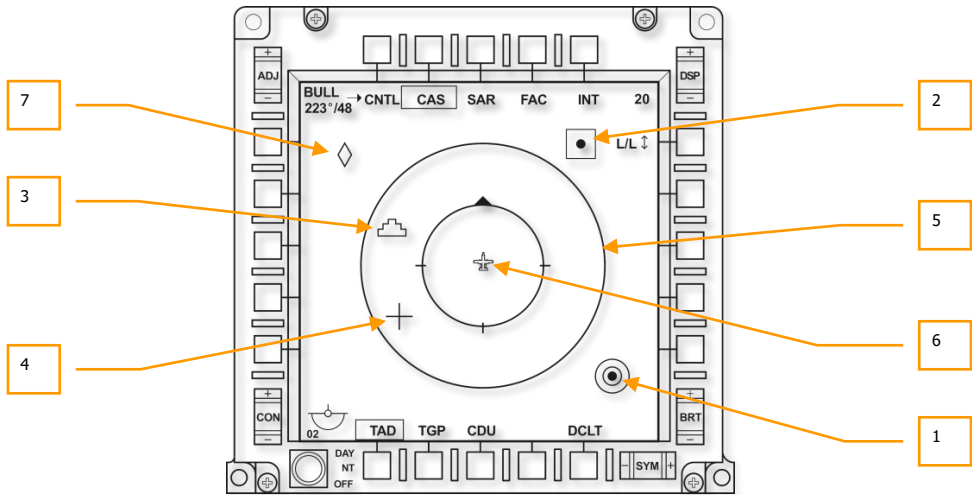

Figure 227. TAD Basic Symbols

In the interior of the display are several symbols that can be displayed. These include:

Bullseye symbol. This symbol represents the location of the Bullseye (Anchor Point as set from CDU EGI) on the TAD. The symbol consists of concentric rings that are centered on a filled circle. Note that Bullseye data can also be displayed on the HUD.



Waypoint/Steerpoint symbol. This square symbol represents either a waypoint or steerpoint; the only difference will be the color of the symbol. When it is a waypoint, it is colored green; when it is the steerpoint, it is colored yellow. To the right of the symbol, its label will be displayed in green if the waypoint label option is set to ON.

If the CDU is set to MISSION or MARK, only the selected waypoint is displayed. If FLT PLAN is selected, all waypoints in the flight plan will be displayed and a green line will connect each waypoint in the order in which the waypoints are listed in the flight plan.

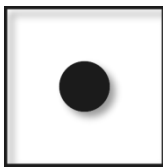

Sensor Point of Interest (SPI) symbol. The SPI symbol on the TAD represents the current SPI that the system is using. This symbol can always be found on the TAD, although you may have to zoom the TAD scale out to locate it. By default, the SPI will be located on the active steerpoint. The SPI symbol has the appearance of a “wedding cake” that includes three steps.

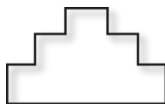

TAD Cursor symbol. Using the HOTAS slew function, you may slew the cross-shaped cursor anywhere within the TAD when the TAD is the SOI. The TAD cursor consists of two perpendicular green lines.



Outer and Inner Range Rings. The range rings are centered on the ownship symbol and provide you a quick means to judge ranges on the TAD. The outside range ring represents the range set on the TAD scale, from ownship symbol to outside range ring. For example, a 20 scale setting equates to 20 nautical miles between the ownship symbol and the outside range ring. When in CEN mode, the diameter of this ring is 90% of the display width. The inner range ring represents half the distance of the set scale, or 50% of the display width when in CEN mode.

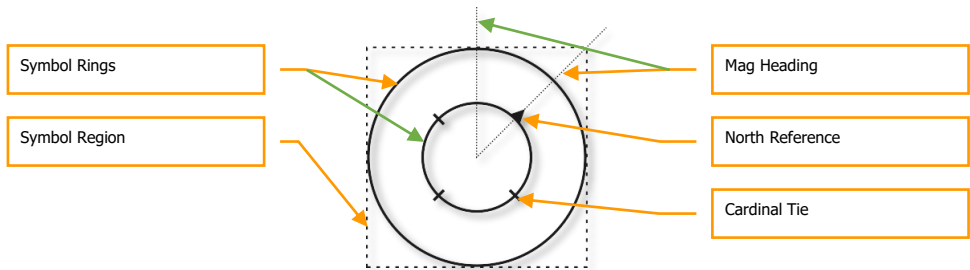

The inner range ring has four tick marks that align with cardinal compass directions. The tick that always points towards magnetic north is actually a filled, equilateral triangle. The other three tick marks are 90° apart and represent east, south, and west.

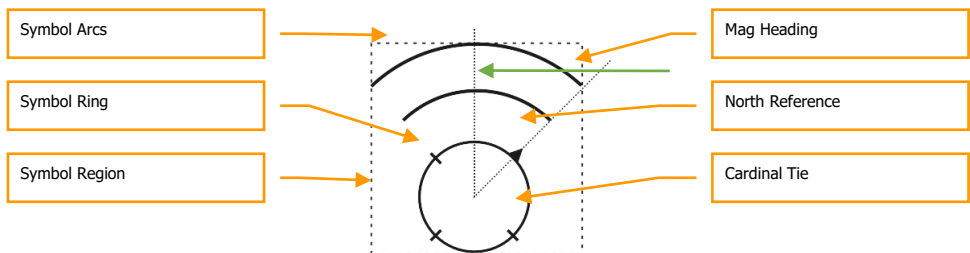

If the TAD is in EXP1 or EXP2 mode, the range rings are not displayed.

When the ownship symbol is displayed in the center of the display and the range rings are centered on it, this is Centered (CEN) mode. However, the TAD can also display the ownship symbol 27.5% from the bottom of the display. This is called Depressed (DEP) mode.

While the inner range ring acts as it does when in CEN mode (just repositioned lower on the display), the outside range ring is replaced with two partial arcs. These two arcs are 130° and are concentric with the inner range ring and centered on the ownship symbol. The arcs have equal spacing, and the outside arc represents the scale setting. The inner arc is twice the diameter of the inner range ring and the outer arc is three times the diameter of the inner range ring.

These range rings/arcs are not displayed when the TAD is in EXP1 or EXP2 mode.

Ownship symbol. This symbol is located either at the center of the display when in CEN mode or 27.5% from the bottom of the display when in DEP mode. The ownship symbol represents your aircraft from a plan form perspective. The symbol is green and colored solid.

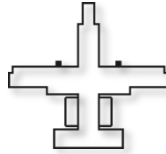

TGP Diamond. When the targeting pod (TGP) is on, a green diamond is displayed on the TAD that represents the line-of-sight point that the TGP is pointed towards.



Main TAD Page



Figure 228. Main TAD Page Functions

From the main TAD page, the following fields and functions are displayed around the periphery of the display. These include:

1. **Go to TAD Profile Control page (CNTL)**, branch OSB 1. Pressing OSB 1 will direct you to the TAD Profile Control page.
7. **Select TAD Profile (XXX, where XXX is profile name)**, OSB 2, 3, 4, and 5. Selecting one of the four profile OSBs will filter the TAD page to only show information specified in the profile. Profile assignment of OSBs and information to be shown in each profile is defined in the Profile Control page.
8. **Field of View Scale (XX, where XX is the scale setting) and Moving Map scale.** Using the increase and decrease field of view HOTAS functions, you may alter the range being displayed on the TAD in discrete increments. The range is defined as the distance between the ownship symbol and the outer range ring in nautical miles.

When the display is in centered mode (CEN), valid range scale values include 5, 10, 20, 40, 80 and 160.

When the display is in depressed mode (DEP), valid range scale values include 7.5, 15, 30, 60, 120 and 240.

The range scale can also be adjusted by moving the TAD cursor to the very top of the display (increase scale), or to the bottom of the display (decrease scale).

Selecting between CEN and DEP mode is accomplished with the CEN/DEP HOTAS function.

Below the FOV scale numeric, the selected moving map scale is displayed. Available scales include (1:(x)K or M):

- 1:250K
- 1:500K
- 1:1M
- 1:2M
- 1:5M

9. **Moving Map Display Mode (OFF, MAN, AUTO)**, rotary OSB 20. This OSB allows you to determine if the moving map is displayed as a background image on the TAD and if the changing of map scales is manual or automatic. The rotary selections are OFF → AUTO → MAN → OFF, etc.

- 1.1. **OFF:** When set to OFF, the moving map air navigation chart is not displayed as a TAD background.
- 1.2. **AUTO:** The moving map display is in automatic mode. In AUTO mode, each map chart format is automatically assigned to its corresponding default map scale. Similarly, each TAD range scale for both the CEN and DEP ownship positions is automatically assigned to a corresponding map scale and, therefore, to a corresponding digital map format.

TAD Range Scale		Corresponding Digital Map Format
CEN Ownship Position	DEP Ownship Position	
5 NM	7.5 NM	JOG (1:250K)
10 NM	15 NM	TPC (1:500K)
20 NM	30 NM	ONC (1:1M)
40 NM	60 NM	JNC (1:2M)

TAD Range Scale		Corresponding Digital Map Format
CEN Ownship Position	DEP Ownship Position	
80 NM	120 NM	GNC (1:5M)
160 NM	240 NM	GNC (1:5M)

If the currently displayed TAD range scale is either increased by using **DMS Forward Short** (or by driving the cursor off the TAD FOV via the slew control) or is decreased by using **DMS Aft Short**, the digital map format displayed on the TAD for the former TAD range scale will automatically change to the appropriate digital map format to be displayed on the TAD for the latter TAD range scale. For example: if the TAD range scale is initially at 10 NM, the digital map scale will be 1:500K. If the TAD range scale is then increased to 20 NM, the digital map scale will automatically be changed to 1:1M (the appropriate digital map scale for the now 20 NM TAD range scale).

In addition, switching to AUTO mode from either OFF mode or MAN mode will cause the TAD to automatically display the digital map format appropriate for the currently displayed TAD range scale. Two possible situations are given below as examples of this functionality:

MAP = OFF	TAD Range Scale	=	10 NM
	Digital Map Scale	=	Undefined, as the digital map display feature is unavailable in OFF Mode
OFF→AUTO	TAD Range Scale	=	10 NM
	Digital Map Format Scale	=	1:500K, as this is the default digital map scale for the 10 NM TAD range scale
MAP = MAN	TAD Range Scale	=	10 NM
	Digital Map Scale	=	1:2M, or a "No Map" TAD range scale/digital map format combination
MAN→AUTO	TAD Range Scale	=	10 NM
	Digital Map Scale	=	1:500K, as this is the default digital map format for the 10 NM TAD range scale

If the currently displayed TAD FOV is changed by using Missile Reject/Uncage Switch (**China Hat Switch Forward**), the following functionalities will occur:

- First Press: TAD FOV changes from NORM mode to EXP1 mode. For any given TAD range scale, this causes the current digital map format to “narrow” by one increment. In other words, if the current digital map scale in NORM mode was 1:2M, it will “narrow” to 1:1M once EXP1 mode is entered, regardless of the TAD range scale that was initially displayed in NORM mode.
 - Next Press: TAD FOV changes from EXP1 mode to EXP2 mode. For any given TAD range scale, this causes the current digital map format to “narrow” by one more increment. In other words, if the current digital map scale in EXP1 mode was 1:1M (as is the case in the previous paragraph), it will “narrow” to 1:500K once EXP2 mode is entered, regardless of the TAD range scale that was initially displayed in NORM mode.
 - Last Press: TAD FOV changes from EXP2 mode back to NORM mode. For any given TAD range scale, this causes the current digital map format to “widen” by two increments back to the digital map format that was originally being used in NORM mode. In other words, if the current digital map scale in EXP2 mode was 1:500K (as is the case in the previous paragraph), it will “widen” back to 1:2M (the initial digital map scale) once NORM mode is reentered, regardless of the TAD range scale that was displayed in NORM mode to begin with.
- a. **MAN:** The digital map display is in manual mode. In MAN mode, the default digital map format for each TAD range scale is the same as when in AUTO mode. In other words, the digital map format displayed on the TAD after changing from OFF mode to MAN mode for a given TAD range scale is the same digital map format that would have been displayed on the TAD after having changed from OFF mode to AUTO mode (for the same TAD range scale).

There is an exception to this functionality in the lowest TAD range scale for both the CEN and DEP ownship positions: Changing from OFF mode to MAN mode while in either of these TAD range scales will result in a “NO MAP” readout to be displayed in the Map Scale Display field. Consequently, no digital map display will be overlaid on the TAD background. In addition, increasing or decreasing the TAD range scale will result in the “NO MAP” readout to continue to be displayed until AUTO mode is entered. At that point, the appropriate digital map format for the currently displayed TAD range scale will be overlaid on the TAD background.

When changing from AUTO mode to MAN mode at any given TAD range scale, the resulting digital map format displayed on the TAD is the same digital map format that was previously being displayed on the TAD in AUTO mode.

In general, the main functionality of MAN mode is to give complete control over the TAD range scale and the digital map format that are currently being displayed on the TAD, irrespective of what value each parameter holds. In other words, the TAD can display any TAD range scale and any digital map format at the same time; therefore, any given TAD range scale/digital map format combination can be achieved. Similarly, if the current TAD range scale is increased or decreased, the currently displayed digital map format will remain unchanged.

The only way for the digital map format to be changed in MAN mode is by using the ADJ rocker switch (located in the upper left corner of the MFCD). ADJ (+) is used to "widen" the current digital map format by one increment (i.e., change from 1:1M to 1:2M), while ADJ (-) is used to "narrow" the current digital map format by one increment (i.e., change from 1:2M to 1:1M). Both functions can be performed regardless of the currently displayed TAD range scale.

There are two points of interest regarding changing the current digital map format (irrespective of the current TAD range scale) while in MAN mode:

The digital map format can only be "widened" or "narrowed" by one increment at a time in the following sequential order (from the "widest" digital map format to the "narrowest" digital map format when moving from left to right, respectively):

1:5M \leftrightarrow 1:2M \leftrightarrow 1:1M \leftrightarrow 1:500K \leftrightarrow **NO MAP** \leftrightarrow 1:250K \leftrightarrow
NO MAP \leftrightarrow 1:100K \leftrightarrow 1:50K

Notice that there are "NO MAP" readouts that occur when changing between the 1:500K and 1:250K digital map scales, as well as when changing between the 1:250K and 1:100K digital map scale. These occurrences produce the same result as was mentioned earlier for a "NO MAP" readout adjacent to OSB-06 on the TAD.

If an attempt is made to "widen" or "narrow" the currently displayed digital map format when it is already at its respective "widest" or "narrowest" value, then the attempt will be stored, and the same digital map format will be refreshed to the TAD. If two consecutive attempts are made, then both attempts will be stored, and the same digital map format will be refreshed to the TAD, and so on.

For example, if the current digital map scale on the TAD is 1:5M, pressing ADJ (+) to "widen" it further will result in the TAD refreshing with 1:5M again, because there is no "wider" digital map format than 1:5M for the TAD to refresh to. However, if ADJ (-) is pressed afterwards to "narrow" the current digital map format by one increment (or in this case, to "narrow" it from 1:5M to 1:2M), the TAD will again refresh with 1:5M rather than 1:2M, because the initial (and unsuccessful) attempt to further "widen" the digital map scale past 1:5M had been stored. Only after a second press of ADJ (-) will the TAD properly refresh with and display 1:2M, the desired digital map scale. (This functionality also applies when more than one attempt is made to further "widen" the "widest" digital map format and equally when one or more attempts are made to further "narrow" the "narrowest" digital map format.)

The "widest" digital map format and the "narrowest" digital map format are relative terms; they both depend on which digital map formats have been loaded.

If the currently displayed TAD FOV is changed by using Missile Reject/Uncage Switch (**China Hat Switch Forward**), the following functionalities will occur:

- First Press: TAD FOV changes from NORM mode to EXP1 mode. For any given TAD range scale, this causes the TAD FOV to "zoom in" by a factor of two when compared with the TAD FOV in NORM mode. The digital map scale that was previously displayed in NORM mode remains the digital map scale that is now displayed in EXP1 mode. As in NORM mode, the digital map format in EXP1 mode can be "widened" or "narrowed" by use of the ADJ rocker switch.
- Next Press: TAD FOV changes from EXP1 mode to EXP2 mode. For any given TAD range scale, this causes the TAD FOV to "zoom in" by a factor of two when compared with the TAD FOV in EXP1 mode. The digital map scale that was previously displayed in EXP1 mode remains the digital map scale that is now displayed in EXP2 mode. As in NORM mode, the digital map format in EXP2 mode can be "widened" or "narrowed" by use of the ADJ rocker switch.
- Last Press: TAD FOV changes from EXP2 mode back to NORM mode. For any given TAD range scale, this causes the TAD FOV to "zoom out" by a factor of four when compared with the TAD FOV in EXP2 mode. The digital map scale that was previously displayed in EXP2 mode remains the digital map scale that is now displayed in NORM mode. As discussed before, the digital map format in NORM mode can be "widened" or "narrowed" by use of the ADJ rocker switch.

10. **Adjust MFCD rocker switch.** This rocker has an up (+) toggle and a down (-) toggle. When TAD is the SOI and the Moving Map mode is in manual (MAN), this rocker is used to cycle the Moving Map scale up and down. Pressing the "+" end of the rocker will cycle to lower scale maps and pressing the "-" will cycle to higher scale maps.

11. **Bullseye Bearing and Range.** Located in the top left corner of the display, the bearing and range to the selected bullseye/anchor point is displayed. This field consists of two lines.

On the top line, "BULL" is displayed.

On the bottom line, from left to right: "(XXX)°/(YYY)" where (XXX) is the bearing to the ownship from the bullseye/anchor point (001 to 360) and (YYY) is the range in nautical miles between the ownship and the bullseye/anchor point. For example:

```
BULL
122°/024
```

This would indicate that the ownship is at a bearing of 122° from the bullseye at a range of 24 nautical miles.

12. **Coordinate Display** (LL, MGRS, OFF), rotary OSB 9. This setting selects either Lat/Long coordinates or Military Grid Reference System (MGRS) coordinates to be displayed at the bottom of the page on a black background when a symbol is tagged.

When the OSB 9 rotary is set to "LL", Lat/Long coordinates are displayed. The top line will be in "N/SXX XX.XXX E/WXXX XX.XXX" format (for example: "N31 17.186 W086 07.074").

When the OSB 9 rotary is set to "MGRS", MGRS coordinates are displayed. The top line will be in "XXA BC YYYYY ZZZZ", where "XX" is zone number, "A" is zone letter, "B" is column letter, "C" is row letter, "YYYYY" is easting value, and "ZZZZ" is northing value.

If OFF is selected, no coordinate will be displayed.

13. **Hook Mode** (TAG: OWN, BULL, or CURS), rotary OSB 18. This OSB function is only displayed when you have hooked a TAD symbol with the cursor. TAD symbols can include the SPI, TGP diamond, waypoint/steerpoint, or bullseye. When a symbol is hooked, the SPI symbol is placed over it and a dashed, yellow line leads from the SPI symbol to the rotary selection.

The top line of the label displays "HOOK" and the bottom line of the label displays either "OWN," "BULL" or "CURS," depending on the rotary selection. For example:

```
HOOK
BULL
```

When a symbol is hooked, its bearing, range and elevation are displayed in the lower right corner of the TAD. The field consists of two lines.

The top line displays the bearing from the selected tag mode (OWN, BULL, CURS) source to the hooked symbol in "XXX°", a "/" followed by the range between the two as "XXX" in nautical miles (for example, "350°/015").

The second line is justified to the right side of the display and lists the altitude at the location of the hooked symbol. This is listed as "XXXX" (for example, "6900").

Also, when a symbol is hooked, its geographic coordinate may be displayed in the lower center of the TAD. However, if the coordinate display setting is set to OFF, the coordinate will not be displayed. Selecting LL or MGRS will determine which coordinate system will be used to display the symbol's location.

If OWN is selected, the hook line will run between the SPI symbol and the ownship symbol.



Figure 229. TAD Ownship Hook

If BULL is selected, the hook line will run between the SPI symbol and the bullseye symbol.



Figure 230. TAD Bullseye Hook

If CURS is selected, the hook line will run between the SPI symbol and the cursor symbol.



Figure 231. TAD Cursor Hook

14. **TAD Copy**, system action OSB 17. This function is only displayed if a symbol has first been hooked. If a symbol is hooked and OSB 17 is pressed, the hooked symbol will be created as a new mission waypoint in the CDU.

If an open mission waypoint is available, the number of the available waypoint will be listed with a "?" mark next to it (for example, "30?").

If no mission waypoints are available in the CDU, database full is indicated by the label:

*DB
FULL*

15. **Declutter**. OSB 11 removes labels except page select. All OSB functions still work, however.

TAD Profile Programs Page



Figure 232. TAD Profile Program Page

This function allows you to decide which profiles are assigned to the Profile Selection OSBs, 2 through 5. Hold down any of the Profile Selection OSBs for more than one second to display the TAD Profile Program page (much like displaying the Display Program Page).

This page lists all the possible profiles to assign to the Profile Select OSBs, and they are listed on OSBs 6 through 9 and 16 through 20. Each profile is listed as a system action. Left-click on its corresponding OSB to select the profile in green reverse video. Pressing the same OSB again will de-select it. With the profile selected, press the Profile Select OSB that you wish to assign the profile to. Upon doing so, the label of the profile will appear under the selected Profile Select OSB.

To remove a profile from a Profile Select OSB, the user may press the CLR system action OSB 10 button and then the Profile Select OSB they wish to clear.

To return to the TAD, the user may press any of the assigned Profile Select OSBs.

Expand Modes

When the TAD is the SOI, you may cycle between 3 view modes.

- **Normal Mode.** This is the default presentation as described above.
- **Expand 1 (EXP 1).** When in Expand 1 mode, the display will center on the current location of the TAD cursor and zoom in 2x field of view scale. The cursor will be stationary in this mode and cannot be slewed; however, the slewing function will now move the map background. When in this mode, the map scale can be set from 1:5M down to 1:50K.
- **Expand 2 (EXP 2).** When in Expand 2 mode, the display will center on the current location of the TAD cursor and zoom in 4x field of view scale. The cursor will be stationary in this mode and cannot be slewed; however, the slewing function will now move the map background. When in this mode, the map scale can be set from 1:5M down to 1:50K.

In both Expand 1 and Expand 2 modes, the range rings and the bullseye information in the top left corner of the display are removed.



Figure 233. TAD Expand Mode1



Figure 234. TAD Expand Mode 2

Selecting Normal display mode returns the TAD to normal operations and to the previous normal settings (slew moves the cursor, range rings visible, bullseye data present, and background moves according to movement of ownship).

TAD Profile Control Page



Figure 235. TAD Profile Control Page

To access the TAD Control page, select the branch (CNTL) OSB 1 from the main TAD page. From this page, you may modify or create TAD profiles. Each TAD profile may be named, and the settings customized. Selecting profiles is done with OSB 2 through 5 from the TAD page.

The TAD Profile page consists of the following unique elements:

1. **Return to TAD page (TAD)**, branch OSB 1. Pressing OSB 1 will return the display back to the TAD page.
2. **Reset TAD Settings to Default (RSET)**, system action OSB 2. Pressing OSB 2 will reset all TAD profiles to their default values. This includes the TAD profiles displayed on the TAD page and their individual names and settings. Default values sets all profile settings to ON.
3. **Save/Delete Profile (SAVE or DEL)**, system action OSB 3. If any changes have been made to the selected Profile's settings, the OSB label will display "SAVE". Pressing OSB 3 in this event will

save the profile with the current settings. If a new name has not been entered with the NEW function, this is how to modify an existing profile.



Figure 236. TAD Delete Profile

If the selected profile has not been modified, however, the OSB 3 label will read "DEL." Pressing this OSB under this circumstance will delete the profile. Upon pressing the OSB, a delete confirmation message will be displayed in white reverse video in the bottom center of the display. Pressing the OSB again will delete the profile and remove the message.

After deletion, the next profile is automatically selected.

If the deleted profile is the only profile, then "DFLT" is displayed as the profile name.

4. **Go to TAD Profile Settings** (CHG SET), branch OSB 16. Pressing OSB 16 will direct the display to the TAD Profile Settings page.
5. **Create Profile Name** (NEW), data entry OSB 18. To enter a new name of the selected profile, press OSB 18 and use the data entry scratchpad to enter a new name up to 4 characters long.

Upon pressing enter/return, "NEW" will be replaced by the entered name. In this way, you can create new profiles.

The maximum number of profiles is 9. If there are 9 profiles, the NEW label will be replaced with:

DB
FULL

In such a situation, you must delete or rename existing profile(s) to create new ones.

No two profiles may have the same name. If you attempt to enter a name that is already being used, the message "TAD DUP PROF" is displayed and the name entry is not taken ("NEW" remains).

6. **Select Profile [profile name]**, navigation OSBs 19 and 20. To cycle profile selection, OSB 19 and OSB 20 are navigation OSBs that cycle profiles (OSB 19 cycles backwards and OSB 20 cycles forward). The name of the profile is displayed between the two navigation arrows. The profile displayed is considered the active profile for editing, saving and deletion.

If settings are changed to a profile and a new profile is cycled to without first saving, those changes will be lost.

For TAD Profile Settings to take effect, the profile must first be selected from the TAD page, OSB 2 through 5.

TAD Profile Settings Page

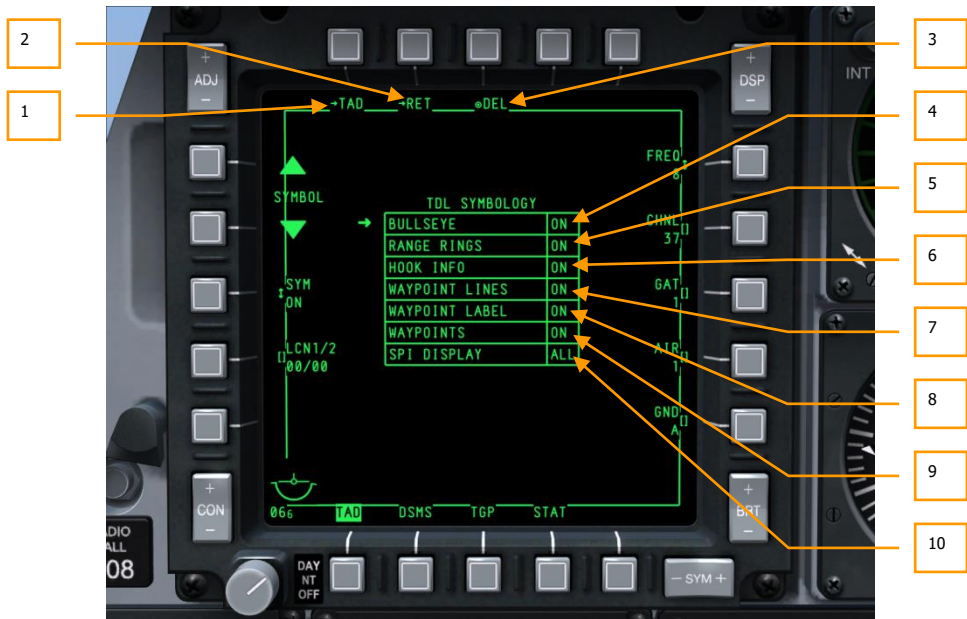

Figure 237. TAD Profile Settings Page

To access the TAD Profile Settings page, select CHG SET branch OSB 16. From this page, you can select unique symbol settings for the selected TAD profile.

The TAD Profile Settings page consists of the following unique elements:

1. **Return to TAD page** (TAD), branch OSB 1. Pressing OSB 1, you will be returned directly to the TAD page, bypassing the TAD Profile Control page.
2. **Return to TAD Profile Control page** (RET), branch OSB 2. Pressing OSB 2 will return you to the TAD Profile Control page.
3. **Save/Delete Profile** (SAVE or DEL), system action OSB 3. If any changes have been made to the selected Profile (as selected from the Profile Control page) settings, the OSB label will display "SAVE." Pressing the OSB 3 label in this event will save the profile with the current settings.

If the selected profile has not been modified, the OSB 3 label will read DEL. Pressing this OSB under this circumstance will delete the profile. Upon pressing the OSB, a delete confirmation message will be displayed in white reverse video in the bottom center of the display. Pressing the OSB again will delete the profile and remove the message.

After deletion, the next profile is automatically selected.

In the center of the page is the TDL SYMBOLOGY table. This table lists all the possible symbols that can be displayed on the TAD according to the selected profile. Each of the seven options have different arguments that can be selected by moving the arrow to the left of the table using OSB 19 and 20 and then pressing OSB 18 SYM to cycle the argument of that option.

4. **BULLSEYE** (ON or OFF). This option allows the display of the bullseye (anchor point) symbol on the TAD.
5. **RANGE RINGS** (ON or OFF). This option allows the display of the range rings on the TAD when not in EXP1 or EXP2 mode.
6. **HOOK INFO** (ON, ACT or OFF). This option determines how the TAD cursor will behave when hooking a TAD symbol. There are 3 options:
 - **ON:** When in ON mode, both Passive and Active Hooking are enabled. With Passive Hooking, you simply need to move the TAD cursor over the symbol to see the hook information (hook line, bullseye bearing and range, and coordinates). In essence, it acts as a "mouse over" function. When the TAD cursor is moved off the symbol, the information is automatically removed. Passive hooking is disabled if a symbol is already tagged.
 - **ACT:** To Active hook a symbol, the TAD cursor must be placed over a symbol and the Hook Symbol HOTAS function initiated (**TMS Forward Short**). Once hooked in this Active manner, the symbol will stay hooked if the cursor is moved off the symbol.
 - **OFF:** This will disable both Passive and Active hooking and no data is displayed when hooking a symbol.
7. **WAYPOINT LINES** (ON or OFF). This option allows the display of lines connecting waypoints when the CDU is in Flight Plan mode.
8. **WAYPOINT LABEL** (ON or OFF). This option allows the display of flight plan steerpoint names next to the steerpoint symbols.
9. **WAYPOINTS** (ON or OFF). This option allows the display of flight plan waypoints on the TAD.
10. **SPI DISPLAY** (ALL or OWN). This option allows you to display just your own SPI symbol (OWN), or all SPI symbols, including flight members (ALL).

Datalink

The A-10C is equipped with the Situational Awareness Link (SA Link) such that it can communicate with friendly forces and be more aware of hostile forces in the operating area. When enabled with the JTRS switch on the AHCP and the OWN and GROUP network (NET) identification is set up properly, the following symbols can be displayed on the TAD.



Figure 238. TAD Datalink Symbols



Flight Members. These are members of the A-10C flight you are assigned to according to your set network configuration page settings. In the center of the circle is the number of the aircraft within the flight as determined by your OWN ID setting. Below the circle, the numeric indicates the aircraft's altitude in thousands of feet.



Friendly SA Link Networked Members. These are other aircraft on the SA Link network but on a separate GROUP ID number. A dot is in the center of the circle and the aircraft's altitude in thousands of feet is below.



Friendly Ground Forces. Green crosses indicate friendly ground forces. Unit must be assigned an Enhanced Position Location Reporting System (EPLRS) radio to broadcast their location.

In addition to the unit symbols, other TAD SA Link graphics are visible in relation to datalink operations:

1. **SPI Broadcast.** When broadcasting your SPI to friendly forces, this field will be lit in reverse video. When broadcasting your SPI, other SA Link equipped units will see your SPI on their displays as a Mini-SPI and a blue line connecting your aircraft icon to your Mini-SPI. If you are flying in a multiplayer mission and wish to send your SPI to other friendly aircraft, you must set SPI to ON using the **TMS Left Long** HOTAS command.
2. **Mini-SPI.** When a SA Link equipped unit is broadcasting its SPI across the SA Link network, it will appear to other SA Link equipped units as a Mini-SPI symbol. This symbol looks like the standard SPI symbol but with one less tier. Connecting this symbol to the broadcast aircraft is a blue line.
3. **NET.** Pressing OSB 10 will display the SA Link Network Configuration page that will allow you to set your OWN and GROUP numbers. On the left side of the page is the OSB to enter your callsign. Using either the UFC or CDU keypads, enter a four-digit call sign and then press OSB 17. Once pressed, the entered callsign will appear. On the right side is the OWN ID. Here you can enter your ownship ID in the selected group for your aircraft. This number will default to the lowest number available in the selected group network. You can also manually enter their ownship ID. However, if you enter an ID already used, you will get a CICU error. Valid entry is 1 to 99. Also on the right side is the GROUP (GRP) ID. This allows you to select the network group that your selected ownship will be part of. Valid entry is 1 to 99. For best JTAC communications, set the NET ID to 01-01.



Figure 239. TAD Network Configuration Page

During a mission, you may get mission tasking from a Joint Terminal Attack Controller (JTAC) or another SA Link-equipped aircraft that will provide you tasking against a ground target. The following displays and symbols are about such tasking.

4. **Assigned Target.** When you receive a target assignment, this red triangle symbol with a dot in the center will appear at the location of the assigned target on the TAD. As with other symbols, you may hook it for detailed data about the target. The appearance of this symbol will coincide with the ATTACK message at the top of the screen. Once received, you can either reply with a CNTCO or WILCO response. The symbol will flash until you respond.
5. **Attack Tasking Message Received.** Upon receiving a JTAC target assignment, the ATTACK message will appear and flash at the top of the screen until you respond with a CNTCO or WILCO response. Once responded to, the message will disappear.
6. **Cannot Comply Response to Tasking.** If you cannot comply (CNTCO) with the target assignment, pressing OSB 7 will clear the Assigned Target symbol and ATTACK message from the TAD.
7. **Wilco Response to Tasking.** If you decide to accept the Target Assignment, press OSB 19 and the Assigned Target symbol will stop flashing and become solid and the ATTACK message will be removed.

You can receive multiple Target Assignments in this manner.

When you receive a new tasking assignment, a NEW TASKING message will appear on both MFCDs regardless of the current page. To remove the message, press **TMS Left Short**. A new tasking from the JTAC will be in the form of a digital 9-line briefing. After you receive the "Point" message from the JTAC, you will get a New Tasking message on the two MFCDs. At the same time, you can view the Message (MSG) page to view the 9-line and a red triangle will be on the TAD at the location of the target. Because this is a TAD object, it can be hooked and be made your SPI.

If you accept the tasking, press WILCO (OSB 19), or press CNTCO (OSB 7) to decline.



Figure 240. New Tasking Message

Tasking targets to other SA Link Aircraft. In addition to receiving Target Assignments from JTAC and other SA Link-equipped aircraft, you can also assign targets to other SA Link-equipped aircraft. This is done through a combination of using the SPI and active hooking. To create a Target Assignment:

Actively hook the SA Link-equipped aircraft you wish to send the Target Assignment to and press the SEND OSB. Upon doing so, the network identification (XX-XX) of the hooked aircraft appears below the SEND label.

Set the SPI to the location of the TAD symbol that you wish to assign as the target. You do not need to be broadcasting SPI to do this. This will set the target location and be visible on the recipient aircraft's TAD.

With the recipient and target set, press the SEND OSB a second time to send the Target Assignment.

Hooking Datalink Symbols. Using the TAD cursor, you can either passively or actively hook a datalink symbol. When you do so, information about that unit will be displayed at the bottom of the TAD.

Friendly Units. The following information is displayed when you hook a friendly unit:

- SA Link Network Configuration Identification number as "XX-XX"
- Callsign
- Coordinates
- Active Profile

Hostile Units. The following information is displayed when you hook a hostile unit:

- Coordinates
- Unit type

Targeting Pod (TGP) Page

The targeting pod provides you the ability to view, track, or designate targets day or night. There are three live video modes: Charge Coupled Device (CCD) (similar to a TV display) and Forward Looking Infrared (FLIR) in both Black Hot and White Hot modes.

All actual TGP symbology and fields are displayed as white on the display.

The main function modes for the TGP include Air-to-Ground (A-G), Air-to-Air (A-A) and Standby (STBY). Each of these modes also has a Control Page that provides you with the ability to configure TGP features (CNTL - Control function). As such, there are 8 distinct TGP pages.

- TGP OFF
- TGP NOT TIMED OUT
- A-G Page
- A-G Control Page
- STBY Page
- STBY Control Page
- A-A Page
- A-A Control Page

Activating the TGP

To access the TGP page, you may select TGP from the Page Select OSBs (OSB 12 through 15). If you select TGP without first setting TGP power to ON from the AHCP, a "TGP OFF" message will be displayed on the TGP MFCD page. In this state, the zoom level/field of view will be displayed in the upper left corner, and the sensor type/radar altitude will be displayed in the upper right corner (these fields will be described in detail later in this document). No TGP sensor video will be displayed.



Figure 241. TGP No Power Page

To fully activate the TGP, you must select ON from the TGP switch on the AHCP. When the TGP is initially activated, the Standby page will be displayed and a "NOT TIMED OUT" message will be displayed in the upper center portion of the display for 60 seconds. This is the time needed for the FLIR sensor to cool down. A "FLIR HOT" message is displayed in white text on a black background with half the text height as the "NOT TIMED OUT" message. After 60 seconds, the message will be removed, video will appear, and the Standby mode page will be selected.



Figure 242. TGP Cool-down Page

TGP Page Common Elements



Figure 243. TGP Common Elements

Several TGP pages share a set of common elements that share the same page locations and functions. In addition to the Attitude Reference Symbol (ARS), the Page Selects and Declutter (DCLT), these include:

1. **Field of View (FOV).** Displayed in the upper left corner of each page, this text field indicates which field of view (FOV) that the TGP is currently in. The FOV can either be in Narrow Field of View (NFOV) or Wide Field of View (WFOV) and these views can vary between the CCD and FLIR sensors in the TGP.

FLIR field of view:

- Wide Field of View (WFOV) is $4^\circ \times 4^\circ$
- Narrow Field of View (NFOV) is $1^\circ \times 1^\circ$
- CCD field of view:
 - Wide Field of View (WFOV) is $3.5^\circ \times 3.5^\circ$

- Narrow Field of View (NFOV) is 1° by 1°
2. **TGP mode, A-G.** Selecting OSB 2 will direct you to the Air-to-Ground (A-G) TGP page.
 3. **TGP mode, standby page (STBY).** Selecting the OSB 3 will direct you to the TGP Standby page.
 4. **TGP mode, A-A.** Selecting OSB 4 will direct you to the Air-to-Air (A-A) TGP page.
 5. **Sensor Type.** Displayed in the upper right corner, this text field indicates the current video mode that the TGP is collecting in. The three options include:
 - **WHOT.** Using the FLIR camera, hot objects appear lighter than a cooler background.
 - **BHOT.** Using the FLIR camera, hot objects appear darker than a cooler background.
 - **CCD.** The Charge Coupled Device camera displays this image. This is a daytime, electro-optical camera.
 6. **Altitude (RADALT).** Below the sensor type field, the aircraft's AGL altitude is displayed and rounded to the nearest 10 feet.
 7. **North Arrow.** A North arrow indicator is displayed in the upper right corner of the display. This indicator consists of a static "N" and an arrow line that overlays it and always points towards North. A second line, with no arrowhead, represents East-West. All lines are always normalized to the ground plane.
 8. **Selected Mask Shape.** Depending on the loading of the aircraft, the predicted masked zones can be pre-set. This is indicated by "M(Selected Shape Letter)". This is a static field in this simulation.
 9. **INS Performance Rating.** When using INS for targeting pod pointing, this value indicates how accurate or inaccurate the INS data is. This is a static field in this simulation.

Standby (STBY) Page



Figure 244. TGP Standby Page

From the TGP mode STBY OSB, you may access the Standby page. Upon activation of the TGP, this will be the first TGP mode screen displayed. After the "NOT TIMED OUT" message has been removed (after 60 seconds), the mode may be exited from by selecting one of the other two TGP modes, the standby control page, or a page select OSB. The following OSB functions may be displayed:

1. **Go to STBY Control (CNTL)** page, branch OSB 1. By left clicking OSB 1, you will be directed to the Standby Control page.
10. **Designator Selection (LSR/IR/BTH)**, rotary OSB 7. This rotary allows you to determine what will act as the designator. Rotary choices include:
 - **LSR.** Laser
 - **IR.** Infrared pointer
 - **BTH.** Both laser and IR pointer function simultaneously

11. **TGP service (SVC)**, system action OSB 18. This function allows servicing of the TGP but is nonfunctional.
12. **Zoom factor**. Within an FOV selection, you may additionally adjust the zoom-factor by zooming in and out. The level of zoom is indicated in the upper left corner of the display. The zoom range goes from 0Z (no zoom) to 9Z (highest level of zoom within FOV). Objects within the TGP field of view double in size from 0 to 9 zoom.

Standby Control Page

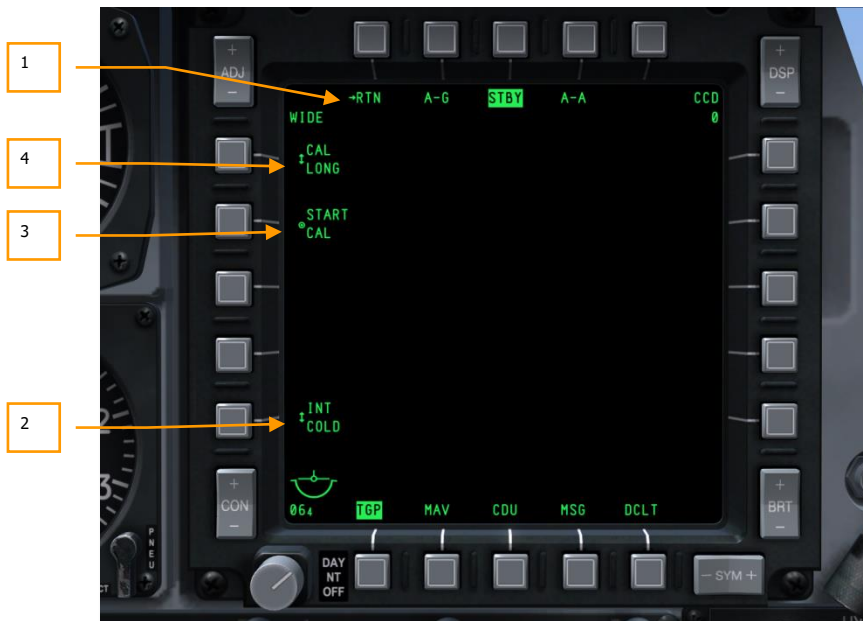

Figure 245. TGP Standby Control Page

Upon selecting OSB 1 from the STBY mode page, you are directed to the STBY control page. This provides an additional set of options.

1. **Return to STBY Mode page (RTN)**, OSB 1. Left clicking OSB 1 will direct you back to the Standby mode page.

2. **FLIR integration (INT HOT/COLD)**, rotary OSB 16. This function allows you to select between Hot and Cold FLIR integration settings. However, this function is not functional. The rotary can be used to select between:

INT	INT
HOT	COLD

3. **Start Calibration (START CAL)**, system action OSB 19. This function would initiate a self-calibration of the TGP.
4. **Calibration method (CAL SHORT/LONG)**, rotary OSB 20. This function determines if the calibration will be a long or short method. The rotary can select between:

CAL	CAL
SHORT	LONG

Air-to-Ground (A-G) Page

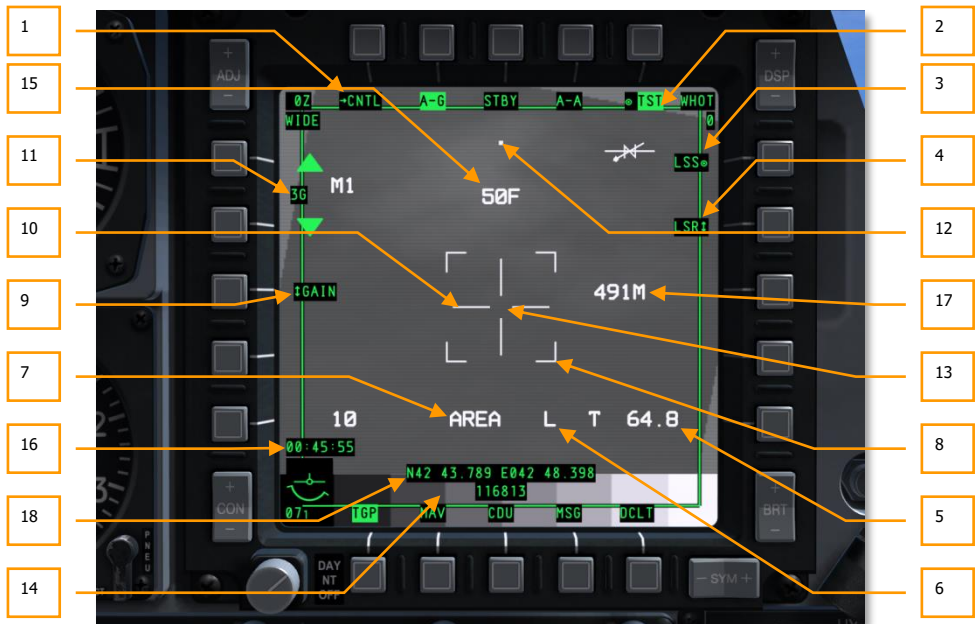

Figure 246. TGP A-G Page

When the A-G mode page is selected after an OSB 2 click, the following elements may be displayed in addition to the common elements.

When A-G mode is first entered, the TGP will boresight at 150 mils below the zero sight line of the aircraft, directly forward.

1. **Go to A-G Control page (CNTL)**, branch OSB 1. Selecting this OSB 1 will direct you to the Control page of A-G mode.
2. **Test display (TST)**, system action OSB 5. This is a toggle OSB that allows the display of the gray-scale test bar near the bottom of the display. However, this option is disabled (label removed and OSB inactive) if CCD camera is active.
3. **Activate LSS mode (LSS)**, system action OSB 6. When OSB 6 is commanded, the TGP automatically enters Laser Spot Search (LSS) mode. When in this mode, the FOV indicator field displays "WSCH" instead of "WIDE" and "NSCH" instead of "NARO." When in LSS mode, the

crosshairs lengthen to stretch to four sides of the display with an open tracking gate in the center.

When the LSS operation starts, the TGP will be searching for a laser designation to track. As such, "LSRCH" will be displayed in the lower center of the display. When the TGP has detected a laser energy reflection, "DETECT" will replace "LSRCH" on the display, and the OSB label will change from "LSS" to "LST" to indicate Laser Spot Track. The TGP line of sight will then automatically slew to the detected laser reflection. After 1 second, "DETECT" will be replaced with "LTRACK" and a box (container) measuring the size of the tracking gate will overlay the laser energy spot.



Figure 247. TGP in LSS Detect Mode



Figure 248. TGP in LSS Tracking Mode

“LTRACK” will continue to be displayed until you exit LSS mode or the TGP loses tracking on the laser energy spot. If the track is lost, “NO LSR” will be displayed at item area [A and D] for one second and then the system will revert to LSRCH mode.

To exit LSS/LST mode, you may:

- Select OSB 6
- Press China Hat Aft Short with the TGP as SOI
- Command a TGP track
- Select laser or IR pointer

On the HUD, the TGP diamond will mark the position of the LST.

If in LSS mode and the TGP is slaved, the FOV setting will be set to WSCH.

If already in a Track mode and commanded to LSS, the FOV will be set to NSCH.

When in LSS/LST mode, OSB 7 is disabled, and the Laser Status field is removed.

4. **Designator Selection (LSR/IR/BTH)**, rotary OSB 7. This rotary allows you to determine what will act as the designator. Rotary choices include:

- **LSR.** Laser
- **IR.** Infrared Pointer
- **BTH.** Both laser and IR pointer function simultaneously

This rotary can also be changed using the Laser Mode Toggle HOTAS function as long as the TGP is the SOI.

Right of the Track Mode field and next to the crosshairs, the selected designator type is displayed.

- **"L"** for laser (Laser switch on AHCP = ARM)
- **"TL"** for training laser (Laser switch on AHCP = TRAIN)
- **"P"** for IR pointer (Laser switch on AHCP = ARM)
- **"TP"** for IR pointer (Laser switch on AHCP = TRAIN)
- **"B"** for both laser and IR pointer (Laser switch on AHCP = ARM)
- **"TB"** for both laser and IR pointer (Laser switch on AHCP = TRAIN)

These same indications are present on the HUD. However, the "T" is never present (i.e., an "L" is displayed with LSR selected and the Laser switch on the AHCP in either ARM or TRAIN).

When the designator is firing, it will flash at 2 Hz.

To fire the selected designator:

LSR

To fire the laser only, the following conditions must be met:

- The TGP switch on the AHCP must be set to ON
- The Laser switch on the AHCP must be set to ARM or TRAIN
- Aircraft must be airborne
- Laser code is entered
- TGP is not masked by own aircraft
- LSR must be selected from OSB 7

IR

To fire the IR pointer only, the following conditions must be met:

- The TGP switch on the AHCP must be set to ON
- The Laser switch on the AHCP must be set to ARM or TRAIN
- TGP is set to A-G mode

- IR must be selected from OSB 7
- Aircraft must be airborne
- TGP is not masked by own aircraft

BTH

To fire both the IR pointer and the laser, the following conditions must be met:

- The TGP switch on the AHCP must be set to ON
- BTH must be selected from OSB 7
- Aircraft must be airborne
- The Laser switch on the AHCP must be set to ARM or TRAIN
- TGP is not masked by own aircraft
- Laser code entered

Manual Lase and Auto Lase. When required laser fire conditions are met, the laser can be fired in either manual or automatic modes. The following is true when the laser is in either ARM or TRAIN mode on the Laser AHCP switch.

- **Manual.** As long as the laser fire control is depressed and Latch is set to OFF, the laser will fire; signaled by the flashing "L."
 - **Latched.** When the laser control is depressed and Latch is set to ON, the laser will fire until the laser fire control is depressed again; signaled by the flashing "L".
 - **Automatic.** If auto-lasing parameters are set in a laser guided bombs profile, the laser will automatically fire to guide the bomb. Automatic mode has two sub-settings in the profile:
 - **ON.** *The laser will activate when the bomb is in the auto-lase window and will continue to fire until 4 seconds after computed weapon impact.*
 - **CONTINUOUS.** *The laser will activate from the time the bomb is released until 4 seconds after computed weapon impact.*
5. **Range and source.** This field displays the slant range from the aircraft to the TGP line of sight and is an indication of how that range is being derived.

All ranges will be computed by the laser if the laser is active and OSB 7 is set to LSR or BTH and the Laser switch on the AHCP is set to ARM. In such a situation, the field will read "L (x)" where "x" is slant range to the target in nautical miles.

If laser ranging is not available and the TGP is tracking a target, then the field will be displayed as "T (x)" where "x" is the slant range to the TGP line of sight point.

If laser ranging is not available and the TGP is slewing and not tracking a target, then the field will be displayed as "E (x)" where "x" is the slant range to the TGP line of sight point.

6. **Laser status.** What is displayed in this field is determined by the setting of the laser switch on the AHCP.

DESIGNATOR	AHCP LASER SETTING	DISPLAY FIELD RESULT
LASER	ARM	L
LASER	TRAIN	TL
IR POINTER	ARM	P
IR POINTER	TRAIN	TP
BOTH	ARM	B
BOTH	TRAIN	TB

When the active designation device is firing, the display field on the TGP display and on the HUD will flash at 2 Hz. When it is not firing, it returns to steady.

If the TGP line of sight is masked by the aircraft, "M" is displayed in this field to the right of the laser type. If masked, the laser will be unable to fire.

7. **Track mode.** If the TGP is in a track mode, this field will indicate the track mode it is in. Types include:
- **AREA.** The TGP has been space stabilized on an overall scene but is not tracking a specified object. If AREA track cannot be maintained due to aircraft masking, it reverts to INR-A mode and will return to the AREA track location if track can be reestablished by unmasking.
 - **POINT.** The TGP has established a track on a specific object/target and is stabilized on it. It will continue tracking even if the target is moving. When tracking in POINT mode, a box is drawn around the edge of the object being tracked. The object does not need to be bounded and the box will not expand to encompass the entire object—it remains a fixed size. If the object cannot be tracked due to aircraft masking, it will revert to INR-P mode, but will return to the POINT track if track can be reestablished by unmasking.
 - **INR-A.** If the TGP is tracking in AREA mode and is masked, Inertial Area (INR-A) is displayed. The TGP will attempt to re-track the area lost when the mask constraint has been eliminated.

- **INR-P.** If the TGP is tracking in POINT mode and is masked, Inertial Point (INR-P) is displayed. The TGP will attempt to re-track the point lost when the mask constraint has been eliminated.
 - **INR.** When in Inertial (INR) mode, the TGP will remain fixed on a geographic reference point.
8. **Field of View (FOV) Indicators.** These four corner brackets are only shown when WIDE FOV is enabled and indicate the portion of the image that will be displayed if NARO FOV is enabled.
9. **Gain and Level Select (GAIN or LVL),** rotary OSB 18. When the FLIR is selected as the sensor, this rotary has two selections: GAIN and LVL. If the CCD is the active sensor, this OSB function is not included on the display.
10. **Crosshair.** The various crosshairs that can be displayed on the A-G TGP mode allow the user to visualize the center of the TGP's line of sight. A-G crosshairs include:
- **Laser Marker Reticle.** When IR Pointer is selected as the designation source, this crosshair will be displayed. This is like the AREA track crosshair but adds small perpendicular lines to each end of the crosshair.
 - **Area Track.** This crosshair forms the basis for the other two types. When an AREA track has been initiated, this simple crosshair will be displayed. Dimensions of this crosshair are:
 - WFOV, FLIR
 - WFOV, CCD
 - NFOV
 - **Point Track.** Like an AREA track crosshair, this crosshair will also include a box at the center of the TGP LOS.

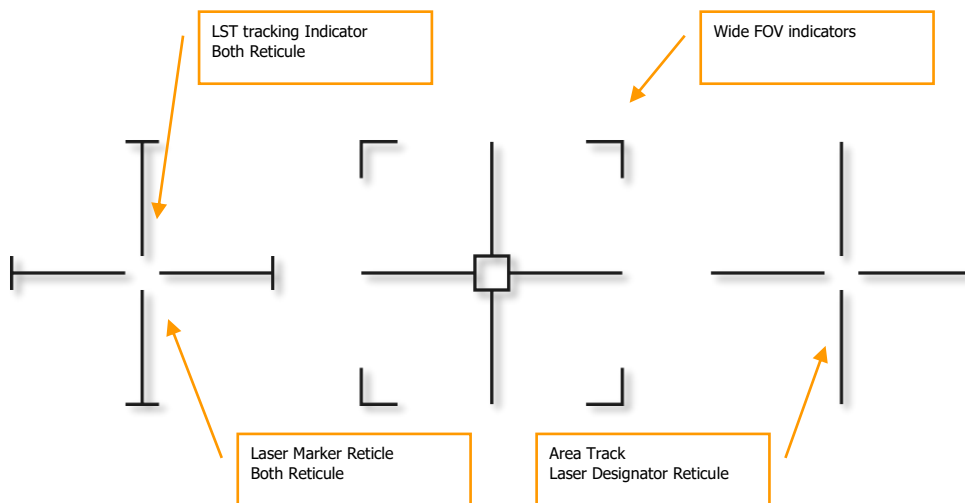

Figure 249. TGP Crosshair Types

A crosshair will flash at 1 Hz when the TGP line of sight is within 5° of being masked by the aircraft.

11. **Gain and Level Schedule Control (XXX)**, navigation OSBs 19 and 20. Depending on the Gain and Level selection on OSB 18, the up and down navigation OSBs will increase or decrease the Gain or Level. The range goes from 1 to 8.

If the Gain Level Select OSB 18 is set to Gain, then a "G" will be added after the value (for example, "3G"). This field is displayed between OSBs 19 and 20.

12. **Situational Awareness Cue.** The SA cue provides you a reference to indicate the TGP's current line of sight in reference to the pod's longitudinal (boresight) axis, which is coincidental with the aircraft longitudinal axis. The cue is represented as a small square that can move to any spot within the circle of the diagram. The position of the SA square represents the current TGP line of sight.

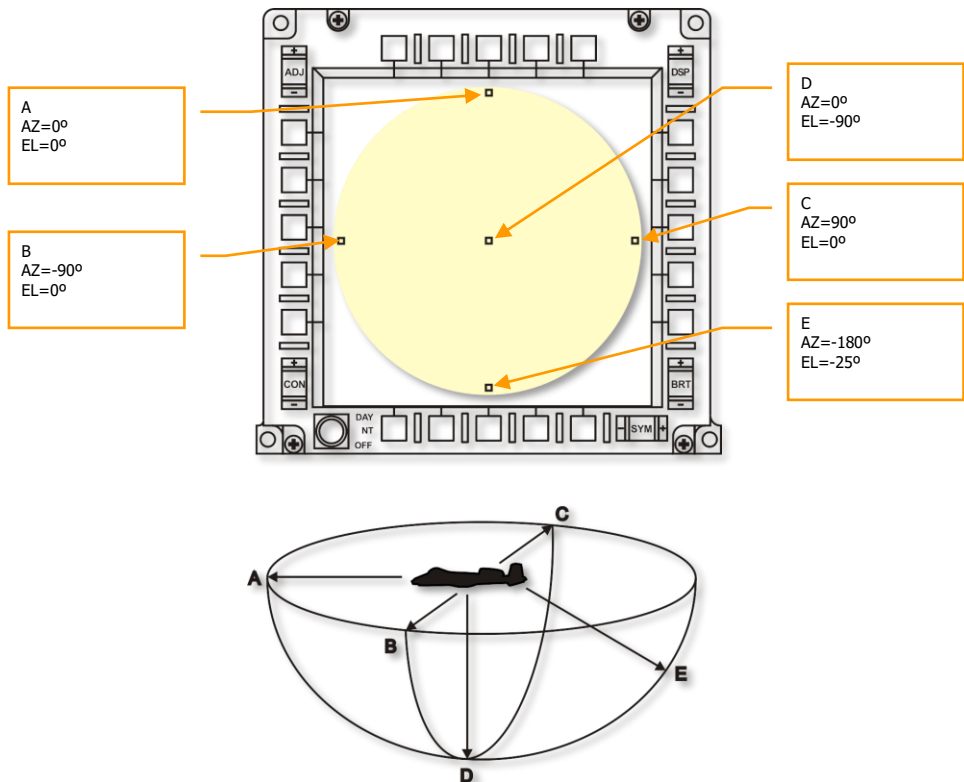

Figure 250. TGP Situational Awareness Cue

The elevation angle of the line of sight is indicated by the distance of the SA cue from the center of the display.

- If the cue is centered in the display, the elevation angle is 90° down (position D)
- If the cue is located at the edge of the circle displayed in the lower diagram above (positions A, B or C), the elevation angle is 0° or level
- If the cue is halfway between the center of the display and the edge of the circle displayed in the diagram, the elevation angle is 25° down (position E)

The azimuth angle is represented as picturing the aircraft in the center of the display, and the SA cue position relative to it indicates the direction the TGP is looking.

- If the cue is located 90° right from the center of the display, the TGP is pointed 90° right of the aircraft.
 - If the cue is located directly below the center of the display, the TGP is pointed directly behind the aircraft.
 - If the cue is located above the center of the display, the TGP is pointed directly in front of the aircraft.
13. **Point Track Box.** When the TGP is in POINT track mode and it has detected enough thermal or visual contrast to track an object/target. A box (container) will be centered on the object/target being tracked. If POINT track is lost, the box will be removed.
 14. **Gray Scale Strip.** When OSB 5 is selected, a gray scale test strip is displayed in the lower center portion of the display. When OSB 5 is pressed a second time, the test strip is removed. This function is only available when FLIR is the active sensor of the TGP.
 15. **Focus.** Above the crosshairs, the focus value is displayed when the TGP is the SOI, and the gray scale strip is active (OSB 5).
 16. **Timer.** This timer field above the Attitude Reference Symbol indicates Zulu time.
 17. **Yardstick.** This numeric, when visible, displays the relative ground distance covered by the right half of the crosshair.
 18. **Coordinate Display.** Either Lat/Long coordinates or Military Grid Reference System (MGRS) coordinates may be displayed at the bottom of the A-G Mode page. The type of coordinate is selected from the A-G Control page.

When the OSB 7 rotary is set to MGRS, MGRS coordinates are displayed for the spot at the center of the crosshair. The top line will be in "XXA BC YYYYY ZZZZ", where XX is zone number, A is a zone letter, B is column letter, C is row letter, YYYYY is easting value, and ZZZZ is northing value.

The lower line indicates altitude in hundreds of feet in the format of "HXXXXX" and indicates the above sea level altitude at the center of the crosshair.

If OFF is selected, no coordinate or height will be displayed.

4. **Latch (LATCH ON or LATCH OFF)**, rotary OSB 8. The latch function allows the laser to be fired as long as the laser fire action is enabled or as a toggle.

When set to OFF, the selected designator(s) will only fire as long as the designator fire action is held down.

When set to ON, selecting the designator fire action once will fire the selected designator(s) and a second press of the action will discontinue it.

5. **Yardstick Metric (METRIC, USA, OFF)**, rotary OSB 9. When enabled to METRIC or USA, a text field is displayed right of the right side of the crosshair. In this field, the relative ground distance covered by the right half of the crosshair is indicated.
 - If METRIC is selected, the distance will be in meters (for example, "3M").
 - If USA is selected, the distance will be in feet (for example, "8FT").
 - If OFF is selected, no Yardstick will be displayed.

6. **Gain control (MGC or AGC)**, rotary OSB 10. This function allows you to select between manual and automatic gain control. No function.

7. **FLIR integration (INT HOT/COLD)**, rotary OSB 16. This function allows you to select between Hot and Cold FLIR integration settings. However, this function will not be functional. The rotary, though, can be used to select between:

INT	INT
HOT	COLD

If CCD is selected as the active sensor, this function will be disabled (label removed and OSB inactive).

8. **LSS Code (LSS)**, data entry OSB 17. Using the scratchpad, you may enter the laser code that will be searched for when in laser spot search (LSS) mode. The entered value can range from 1111 to 1788, but the first digit of the series must be a 1 and the last three digits must be

between 1 and 8. The inputted number is displayed below the LSS OSB label. If an invalid number is inputted, an "INPUT ERROR" WCN is displayed in the center of the display.

9. **Laser Designation Code (L)**, data entry OSB 18. Using the scratchpad, you may enter the laser designation code. The entered value can range from 1111 to 1788, but the first digit of the series must be a 1 and the last three digits must be between 1 and 8. The inputted number is displayed below the L OSB label. If an invalid number is inputted, an "INPUT ERROR" WCN is displayed in the center of the display.
10. **TGP Attitude Advisory Function (TAAF)**, data entry OSB 20. Using the scratchpad, you may enter the Attitude Advisory value in feet. Valid values range from 0 to 65000. If 0 is entered, TAAF is disabled. The default setting is 10,000 feet. The TAAF warning will be triggered if the aircraft is below the set attitude and its bank angle is greater than 75° with a pitch less than 0° , and/or pitch angle is less than -20° . The warning consists of a "CHECK ATTITUDE" in red reverse video on both MFCDs. The warning is automatically removed when advisory warning conditions no longer exist.

The entered value is displayed below the TAAF OSB label.

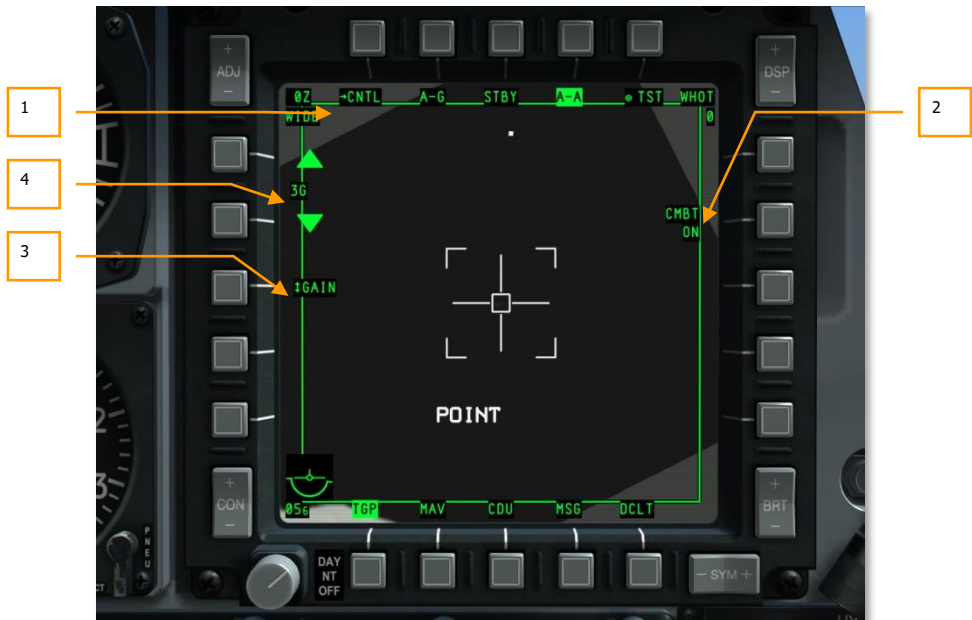

Figure 252. TGP TAAF WCN**Air-to-Air (A-A) Page****Figure 253. TGP A-A Page**

To access the A-A mode, you may select OSB 4 (A-A). This will direct you to the A-A mode page. The A-A mode is especially configured for air-to-air operations.

When A-A mode is first entered, the TGP will boresight at 41 mils below its longitudinal axis, directly forward.

1. **Go to A-A Control Page (CNTL)**, branch OSB 1. To access the nested A-A Control page, select OSB 1.
2. **Laser Mode (CMBT ON/OFF and TRNG ON/OFF)**, OSB 7. This is a notification field and cannot be altered and is set on the A-A Control page.

If the Laser switch on the AHCP is set to TRAIN, then "TRNG" will appear on the top line of the label.

If the Laser switch on the AHCP is set to ARM, then "CMBT" will appear on the top line of the label.

3. **Gain and Level Select.** Gain and Level Select (GAIN or LVL), rotary OSB 18. When the FLIR is selected as the sensor, this rotary has two selections: GAIN and LVL. If the CCD is the active sensor, this OSB function is not included on the display.
4. **Gain and Level Schedule Control.** Gain and Level Schedule Control (XXX), navigation OSBs 19 and 20. Depending on the Gain and Level selection on OSB 18, the up and down navigation OSBs will increase or decrease the Gain or Level. The range goes from 1 to 8.

If the Gain Level Select OSB 18 is set to Gain, then a "G" will be added after the value (for example, "3G"). This field is displayed between OSBs 19 and 20.

These controls are only displayed if FLIR is the active sensor.

A-A Modes

When A-A is first entered, the TGP will enter A-A boresight mode, represented by the elongated crosshairs.

IMPORTANT: When in TGP A-A mode, there is no TGP line of sight indication (diamond) displayed on the HUD.



Figure 254. TGP A-A Default

From the boresight mode, you may slew the TGP crosshair using the slew switch. When slewing, the TGP camera moves in a space stabilized manner. When in this slewed mode, but not tracking a target, "RATES" is indicated on the display. After being slewed, the crosshairs will be reduced to half-size.



Figure 255. TGP A-A Slew Rates

If the valid air target passes within the narrow field of view area (represented by the four corner markers), the TGP will attempt to track the target and place a cross "+" on it. If the target flies outside the narrow field of view area, the cross will disappear.

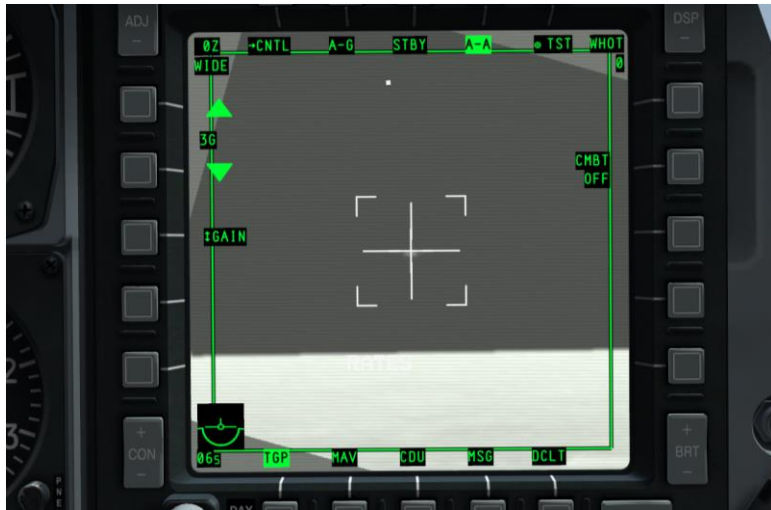

Figure 256. TGP A-A Target Detect

If you then command **TMS Forward Short** HOTAS command (command point track), the target will be centered in the crosshair and a box will be drawn around the target to conform to its size. When in this mode, "POINT" will be displayed as well as the tracking cross. To exit POINT track, the user may command INR track and return to RATES mode.



Figure 257. TGP A-A Target Tracking

- **RATES.** When in A-A mode and the slew function is released, the TGP will automatically enter RATES mode (indicated in the tracking-type field).
- **POINT.** As with A-G mode, the user may command a Point track over an object.
- **INR-P.** If the TGP is tracking in POINT mode and is masked, INR-P is displayed. The TGP will attempt to re-track the point lost when the mask constraint has been eliminated.

A-A Control Page



Figure 258. TGP A-A Control Page

To access the A-A Mode Control page, you may select branch OSB 1 (CNTL) from the A-A Mode page. From this page, the user may create additional settings for the A-A mode.

Return to A-A Mode. Return to A-A Mode (RTN) page, branch OSB 1. Selecting OSB 1 will return the user to the A-A Mode page.

1. **Laser Mode** (CMBT ON/OFF and TRNG ON/OFF), system action OSB 7.

If the Laser switch on the AHCP is set to TRAIN, then "TRNG" will appear on the top line of the label. The system action OSB can be used to cycle the lower line of the label to ON and OFF. If set to OFF, the laser will be unable to fire.

If the Laser switch on the AHCP is set to ARM, then "CMBT" will appear on the top line of the label. The system action OSB can be used to cycle the lower line of the label to ON and OFF. If set to OFF, the laser will be unable to fire.

2. **Gain control** (MGC or AGC), rotary OSB 10. This function allows you to select between manual and automatic gain control.
3. **FLIR integration** (INT HOT/COLD), rotary OSB 16. This function allows you to select between Hot and Cold FLIR integration settings. The rotary can be used to select between:

INT	INT
HOT	COLD

If CCD is selected as the active sensor, this function will be disabled (label removed and OSB inactive).

TGP Indicators on Other Pages

TAD

When the TGP is in operation, the TAD includes a diamond symbol indicating the current position of the TGP seeker head, provided the coordinates are within the current TAD scale range.

HUD

When the TGP is in operation, aspects of its operation may be displayed on the HUD. These include:

- Laser Designation Indication (L)
- IR Pointer Designation Indication (P)
- Laser and IR Pointer being used simultaneously (B)
- TGP Seeker Head Position Symbol (diamond symbol)
- SOI Indication (asterisk)
- SPI Indication (SPI locator line)
- Target Mask Indication (M)

TAAF

When a TAAF advisory is made due to the following conditions, a "WARNING" message is displayed on the lower center of the HUD.

The TAAF warning will be triggered if the aircraft is below the set TAAF altitude and its bank angle is greater than 75° with a pitch less than 0°, and/or pitch angle is less than -20°.

The warning is automatically removed when advisory warning conditions no longer exist.

Maverick (MAV) Page

AGM-65D/G/H/K, TGM-65D/GH, and CATM-65K Maverick control in the A-10C is similar to the A-10A with the exception that the Maverick video from the sensor is displayed on either MFCD rather than a dedicated TV Monitor. The Maverick is a precision-guided air-to-ground missile that can be used against armored vehicles and fortifications. The Maverick has several variants that differ in warhead size and type of seeker (CCD or Infrared). All types of Maverick though use a gyro-stabilization system that must be aligned before use.

Maverick Operational Times. Time of alignment is 3 minutes. Alignment starts when EO power is applied to a Maverick. Anytime EO power is set to off, alignment must be restarted when EO power is re-applied.

Maverick Launchers. Mavericks can be loaded on two types of launchers: the LAU-88 (up to three missiles per launcher) and the LAU-117 (single missile per launcher). For the heavier versions of the Maverick like the G and K versions, the LAU-117 is the only option.

- **LAU-88** can carry up to three Mavericks on either station 9 or 3; station 9 is the priority station.
- **LAU-117** can only carry a single Maverick on either station 9 or 3; station 9 is the priority station.

Maverick Selection/Activation. Mavericks can be accessed as follows:

- **Page Select OSB.** By pressing an OSB (12 through 15) that has the MAV legend over it, you can go directly to the Maverick page. Selecting the Maverick this way, you can use it as a sensor or a weapon (assuming a Maverick profile has not already been selected).
- **HOTAS select.** When the HUD is the SOI, the HOTAS can be used to select a Maverick profile from the HUD rotary. This automatically displays the Maverick page and assigns it as the SOI. Maverick will be used as a weapon when selected this way. Maverick will automatically be set to Standby mode (no seeker video is displayed) if it is not displayed on either MFCD and has not been slaved or ground stabilized. When the Maverick has been selected, the priority missile will automatically be activated. Maverick priority is determined by:

If Maverick is loaded on LAU-88, station 9 will have priority over station 3 by default. The outboard rail will be first selected, then the center rail, and last the inboard rail. Only after all missiles have been expended from the station selection will automatically transfer to station 3. With station 3 selected, Maverick will be cycled the same way: outboard, then center, then inboard. Using the missile reject function, this is the order in which Maverick is cycled as well.

If Maverick is loaded on LAU-117, the Maverick on station 9 will be the priority, but the user can use the missile reject function to select station 3 instead.

Once a Maverick is selected, the seeker video will be displayed on the MFC. However, video will not be displayed until 3 minutes have elapsed since activation; this will represent gyro spin-up for the missile. During this time, ALIGN is displayed in the center of the display. For video to be displayed, the following requirements must be met:

- Master Arm set to ARM
- A Maverick must be loaded on the aircraft
- EO Power set to ON (from Maverick page or DSMS Missile Control page)
- The 3-minute align time has been satisfied

Maverick Launch Inhibits

To launch a Maverick, the following conditions must be met:

- LAU-88 or LAU-117 is present
- Store quantity must be greater than zero
- A Maverick DSMS profile must be active
- The weapon station must be ARM through the Master Arm setting
- Not in align mode
- Flaps must be in the full-up position

Maverick can be launched even if the Maverick page is not the SOI.

Cycling Maverick Stations

When a Maverick is launched, the next missile in priority is automatically selected and its video is displayed on the Maverick page.

If the aircraft is using LAU-117 (which carries a single Maverick) stations, each reject of the selected Maverick will cycle to the next station, if there is another station (not the next missile on the same station). After a Maverick has been launched from a LAU-117, the next Maverick in priority will be selected and its seeker will be slewed to boresight.

If the aircraft is using LAU-88 (carries up to three Mavericks) stations, each reject will cycle to the next Maverick in priority on the station before cycling to the next station. After a Maverick has been launched from a LAU-88, the next Maverick in priority will be selected and its seeker will be slewed to the prior Maverick's aim point (rapid fire mode / Quick Draw).

To cycle between the two stations, both must be selected as Weapon or Sensor, but not a mix of the two.

Maverick Modes

Standby. Maverick EO power is on but no video is displayed.

Align. Maverick has EO power applied and will require a 3-minute spin-up period before video will be displayed. During this 3-minute period, "ALIGN" is displayed.

Boresight. After a Maverick has been activated, this is the fixed starting position of the seeker and HUD reticle; it is 150 mils from sight line by default. When the Maverick seeker is re-caged, this is the position it will return to from a track or stabilized ground track.

Slew. When the Maverick seeker is being moved within its field of regard, it is considered in a "slew state." Using the slew switch, you may move the seeker's field of view center within its gimbal limits. When the targeting gate is slewed and released, the seeker will attempt to track a target under or near the gate. If no lock is achieved, it will not be stabilized.

Slave. Using the slave to SPI function, the Maverick seeker position can be automatically slewed to the SPI. When slaved to a SPI, the Maverick acts as if in a ground stabilize mode but will not automatically start tracking.

Ground Stabilize. Using the ground stabilize function, the Maverick seeker can be made to track a designated point on the ground. Note that this will not track a target. When slewed off, the seeker will no longer be stabilized unless commanded with TMS Aft or Left Short.

Track. At the end of slew command, the seeker will automatically attempt to acquire and track a target within the tracking gate by using the tracking polarity of the target. If tracking fails, it will automatically go into break lock mode (expanded crosshairs).

Maverick Page Display

In addition to seeker video, additional information is overlaid on the Maverick page display. These overlays can be removed with the Declutter (DCLT) OSB.

Seeker Status Messages

To provide information on the state of the selected Maverick, text can be displayed 1/3 from the top of the display. This green text overlays the seeker video and symbols and provides information regarding seeker status:



Figure 259. Maverick Alignment

- **NO MAVERICK.** A Maverick has not been detected on the station according to the DSMS profile.
- **OFF.** EO power to the Maverick is set to OFF.
- **ALIGN.** The Maverick is aligning its gyros. This process takes 3 minutes after missile activation.
- **MASTER ARM SAFE.** Master Arm switch is set to SAFE on the AHCP.
- **FLAPS.** Flap position is down, and Maverick may not be launched.
- **GIMBAL LIMITS.** The Maverick seeker has reached its gimbal limits.
- **POWERING OFF.** Maverick EO power has been set to OFF. Power-off process takes 2 seconds.
- **NO TRACK LAUNCH IHBT.** If the Maverick is in a non-track state and launch of the weapon is attempted, this message will be displayed.

Maverick as Sensor

To use the Maverick in such a manner, you must ensure that:

- Master is set to ARM or TRAIN on the AHCP
- EO power is set to ON (OSB 6)

- Maverick gyro has been aligned
- No Maverick profile selected

This can be set even if a non-Maverick profile is active and regardless of other weapon settings.

As long as the Maverick is unarmed from the DSMS, it will act as a sensor. This is indicated by "SENSOR" being displayed vertically along the left side of the page.

Maverick as Weapon

To employ the Maverick as a weapon, you may use two methods:

- Master is set to ARM on the AHCP
- EO power is set to ON (OSB 6)
- Maverick gyro has been aligned

From HUD. With HUD as SOI, cycle rotary profiles until Maverick profile is selected.

From DSMS Profile. From the Main Profile page, select the Maverick profile and set the profile to Active (ACT PRO)

Manual. From the DSMS Status page, press the OSB corresponding to a loaded Maverick. This will create a manual profile (MAN/Maverick)

Once the Maverick is selected as weapon, a dynamic launch zone (DLZ) will be shown along the left side of the display.

Maverick Display Fields

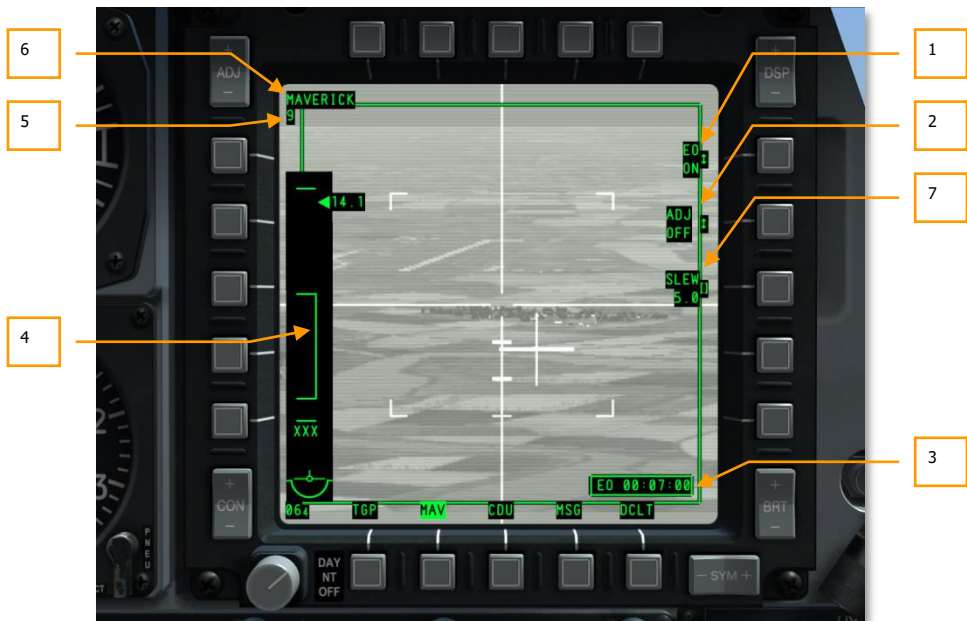

Figure 260. Maverick Display Fields

1. **EO Power.** The EO Power function (OSB 6), allows you to manually apply power to all Maverick stations. The OSB is a rotary with two settings: ON and OFF. The default setting is OFF. When EO Power is set to ON, the EO Timer is automatically displayed and started.
2. **Adjust Boresight.** The ADJ OSB allows you to adjust the boresight position of the Maverick. To do so, slew the Maverick to the desired boresight position and then press OSB 7. The next time you cage the missile to boresight, it will automatically cage to the set position.
3. **EO Power Timer.** When the EO Power function has been set to ON, this timer is automatically displayed and started. This timer displays the elapsed time since EO power was applied and counts up in hours:minutes:seconds. When EO power is set to OFF, the timer is removed from the display and reset; this will also reset the alignment time.
4. **Dynamic Launch Zone (DLZ).** When the Maverick is active as a weapon, the DLZ is displayed along the left side of the page. The DLZ consists of a compilation of symbols that indicate

Maverick maximum and minimum range, allowable launch window, range caret and attached digital range, and a missile time of flight indicator.

Upper and Lower Ticks. These display the maximum and minimum possible ranges of the selected Maverick. These ticks are static and do not move dynamically. The distance between the two is approximately 15 nautical miles.

Note. The maximum range of the Maverick is most often limited to sensor tracking than physical distance the missile can fly. Maximum tracking distance is generally around 7 nm.

Staple. This area represents the dynamic minimum and maximum range of the selected Maverick and will adjust according to speed and altitude. The staple will not be displayed if the Maverick gimbal limit exceeds 30° laterally.

Range Caret and Numeric. This caret represents the range from the aircraft to the ground point which the Maverick HUD reticle is over. The caret can move between the upper and lower ticks. When outside of maximum range, the caret is fixed to the upper tick mark. Attached to the caret is the range numeric. This range numeric is only displayed when the caret is within the top and lower ends of the staple.

Time of Flight Numeric. When the designated area/target under the reticle is within the top and bottom of the staple, the Maverick time of flight to reach the area under the reticle is displayed in seconds. When the reticle is outside the staple, "XXX" is displayed in this field. After the Maverick has been launched, the timer will count down to zero and then flash for 5 seconds before being blank.

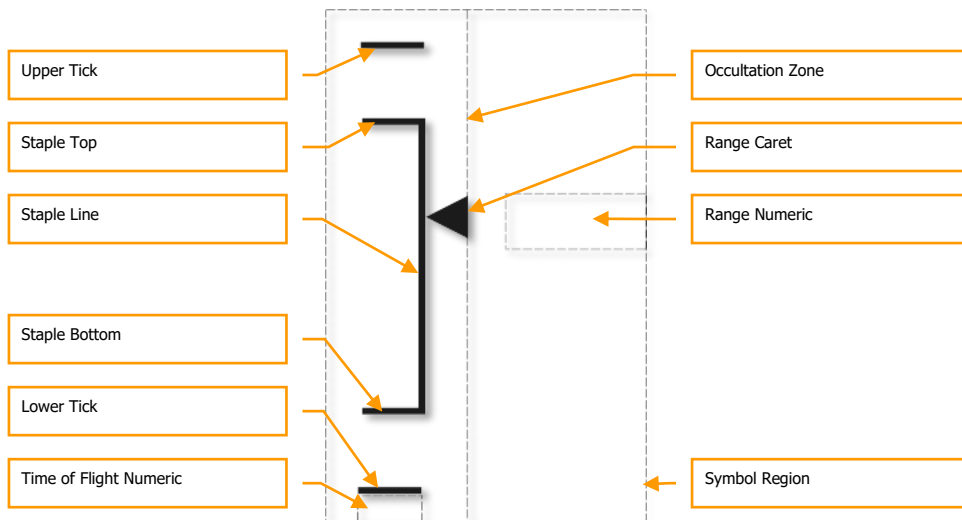

Maverick as Sensor. In place of the DLZ, "SENSOR" will be indicated vertically if a Maverick profile has not been selected.

5. **Active Maverick Station.** This indicator will show "3" if the active Maverick station is station 3. If the active Maverick station is 9, this field will display "9."
6. **Profile Name.** The name of the selected Maverick profile is listed in this field.
7. **SLEW.** The SLEW data field allows you to adjust the Maverick slew rate according to the value entered. To adjust the rate, enter the rate in either the UFC or CDU keypad and press OSB 8.

Optical Maverick Display Symbols

When the Maverick display is set to Black Hot, the symbols are colored black; when set to White Hot or Auto, the symbols are colored white. However, if the Maverick is tracking a target (in track mode), any polarity change will not take effect until the Maverick is re-caged or has reentered slew mode.

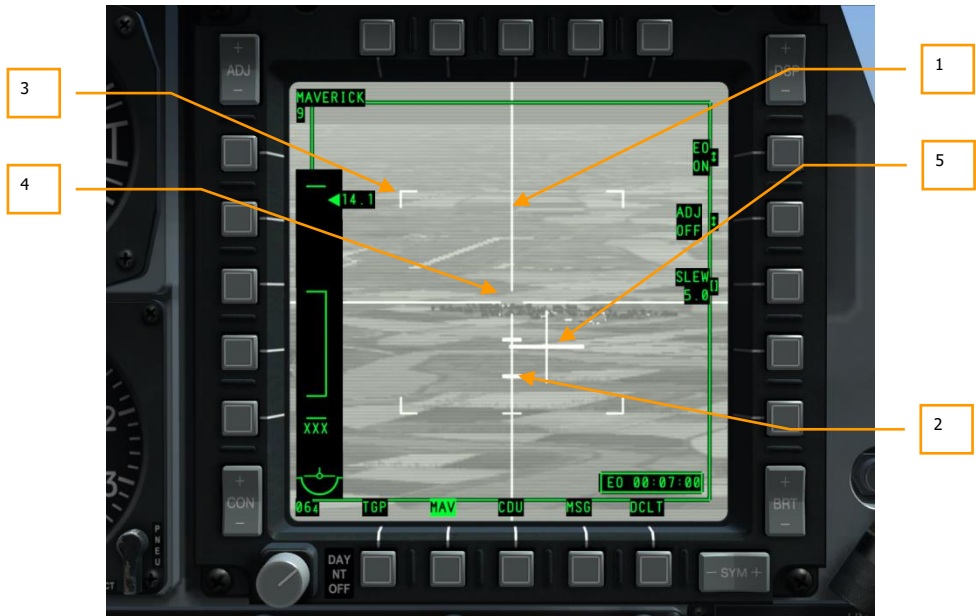

Figure 261. Optical Maverick Display Symbols

1. **Crosshairs.** These horizontal and vertical lines span the horizontal width and vertical height (44 × 44 mils) of the display and have an open gap in the center. This central gap marks the tracking gate you need to place over a target to command a track on it. The size of this gap can vary according to the Maverick type and what field of view setting the missile is in.
2. **Depression Markers.** Along the lower axis of the crosshairs, three static marks are located to represent angular depression. The three marks represent 5°, 10° and 15° depression from the center of the crosshairs.
3. **FOV Corner Markers.** When the Maverick is in Wide Field of View (WFOV) mode, four corner markers are present on the display. These corner markers represent the field of view if the display is changed to Narrow Field of View (NFOV) mode. FOV corner markers are not displayed when in NFOV mode.
4. **Tracking Gate.** The tracking gate is located at the intersection of the horizontal and vertical crosshairs elements. The tracking gate represents where the seeker will attempt to lock/track a target. The tracking gate may grow if locked on to a target larger than the dimensions of the default tracking gate.

5. **Pointing Cross.** The pointing cross indicates the relative direction that the Maverick seeker is looking in reference to the longitudinal axis of the aircraft. The pointing cross will flash when the seeker is tracking a target. If not locked though, it will be steady.

Laser Maverick Display Symbols



Figure 262. Laser Maverick Display Symbols

1. **Laser Code.** The laser search code is displayed at the top.
2. **Gimbal Pointing Indicator (GPI).** Prior to laser detection, this symbol will be an "X". It indicates the pointing center of the scan. Using the slew control, the user may slew the GPI up or down to scan at a depressed angle. Using a China Hat aft command, the user may reset the GPI back to center.

Once the Maverick has detected a laser emission, this symbol changes to a square.

3. **Launch Constraint Circle.** This is a 15° circle that indicates that maximum off boresight launch limit.
4. **20° Hash Mark.** This horizontal line at the bottom of the display indicates 20° down from the center point.

Optical Maverick Tracking Types

Centroid Tracking

When the Maverick is in centroid track mode, it will attempt to lock the tracking gate on an object with sufficient visual or thermal contrast within the tracking gate. The seeker is essentially locking onto and centering its lock on the center of the target. When locked, the horizontal and vertical crosshairs line elements will expand to the dimensions of the target. The area within the tracking gate will conform to the size and shape of the target being tracked.

If in centroid track, Aided Target Acquisition (ATA) can be used. When you designate a lock (released slew over the intended target) with no viable target under the tracking gate, ATA mode will automatically search the area around the gate for a target and automatically lock the closest. If it cannot find a target to lock on to, it will go into break lock mode and the crosshairs will expand out.

If the target is centered in the tracking gate and within range, you can also press TMS Forward Short to manually command a lock.

Force Correlate Tracking

When in force correlate mode, the Maverick seeker is not tracking the actual object but rather a fixed position according to an image of a scene it builds. This allows the Maverick to target a specified section of a larger object such as a building, bunker, or ship. When slewing, the crosshairs will have a gap, but when slew is released and a lock/track is commanded, the gap will collapse to form a perfect cross with no gate. The center of the cross designates the missile impact point.

All optical Maverick versions except AGM/TGM-65D have force correlate mode.

Force correlate is always displayed with white symbols.

To enter force correlate mode, the **Boat Switch** must be in the center position and held there for greater than 1 second while no target is locked.

For a more detailed discussion on Maverick use, please reference the Combat Employment chapter.

Set Default Boresight Location

When the Maverick is first selected or it is commanded to boresight, its seeker will be commanded to its default boresight location. If you wish, you can change this location by:

1. Set MAV to SENSOR mode
2. Lock a ground or air target with the Maverick
3. Set the Boat Switch to the center (AUTO) position. When you do so, SEEKER BORESIGHT will display on the MAV page
4. Place the Depressible Pipper over the locked target and press TMS Forward Short. When you do so, the SEEKER BORESIGHT message will switch to reverse video.
5. Move the Boat Switch out of the center (AUTO) position.
6. Boresight Symbol to Maverick Line of Sight

To further refine the boresight, you can:

1. Set MAV page as SOI
2. Lock an air or ground target with the Maverick
3. Press OSB 6 on the MAV page and ADJ OFF to change to ADJ ON.
4. Move the Maverick symbol by pressing the DMS switch Up, Down, Left, and Right until it is over the target
5. Press the ENT button on the UFC

Message (MSG) Page

When linked into the Situational Awareness Link (SA Link) network, you can send and receive text messages from other SA Link-equipped units (air and ground). Such messages could range from detailed Close Air Support (CAS) tasking messages to dinner plans!

Using either the CDU or UFC keypads, you can enter up to ten lines of text with 24 characters each. In many ways, it can be like Instant Messaging (IM) online.

When you receive a text message, you will receive a notice on both MFCDs regardless of their operating page. This appears as a text box in the lower right corner of the screen reading NEW MSG. You can clear the note with a **TMS Left Short** press.

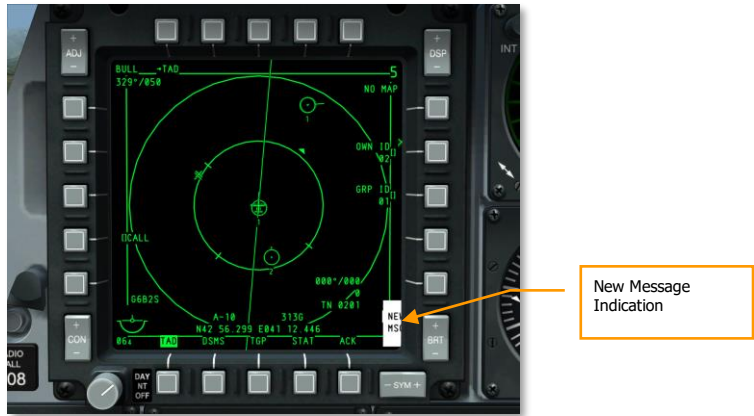

Figure 263. New Message Indication

Received Messages Page

If you now select the MSG page (OSB 11 – 15) you will be directed to the Received (RCVD) Messages Page. This page allows you to cycle through and read all received messages.

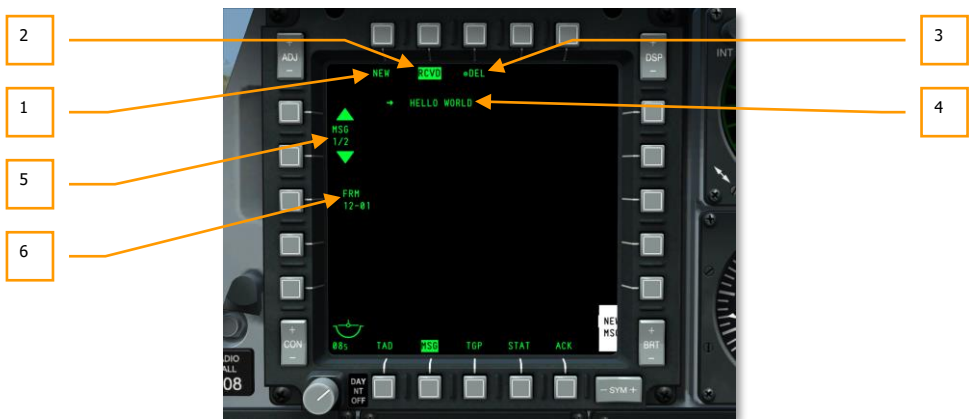

Figure 264. Received Messages Page

1. **New Message (NEW)**, OSB 1. Pressing OSB 1 will direct you to the Send Message Page and will allow you to send messages to other SA Link-equipped units.
2. **Received Messages (RCVD)**, OSB 2. The reverse video RCVD label indicates that you are in the Received Messages Page. This page allows you to receive and delete text messages from other SA Link-equipped units.
3. **Delete Message (DEL)**, OSB 3. When in the Received Messages Page, OSB 3 will be labeled DEL, and when pressed, will delete the currently viewed message from the received text message database.
4. **Received Message**. Each received message can be up to 10 lines in length with 24 characters each.
5. **Cycle / Select Message (MSG X/X)**, OSB 19 and OSB 20. Pressing OSB 19 and 20, you can cycle through your received messages. OSB 20 cycles to more recent messages and OSB 19 cycles to older messages. Next to the MSG label is an indication of the current message / total number of messages in message database.
6. **Message From (FRM)**, OSB 18. Below the FRM label is the network ID of the sender of the viewed message (Unit ID – Group ID). You can read more about network configuration in the SA Link datalink chapter.

Send Message Page

If you select the Message (MSG) page from OSB 11-15 without an incoming message notification first, you will be directed to the Send Message Page. You can also access this page from the Received Messages Page by pressing the NEW OSB 1. This page allows you to create and send a text message to a SA Link-equipped unit.

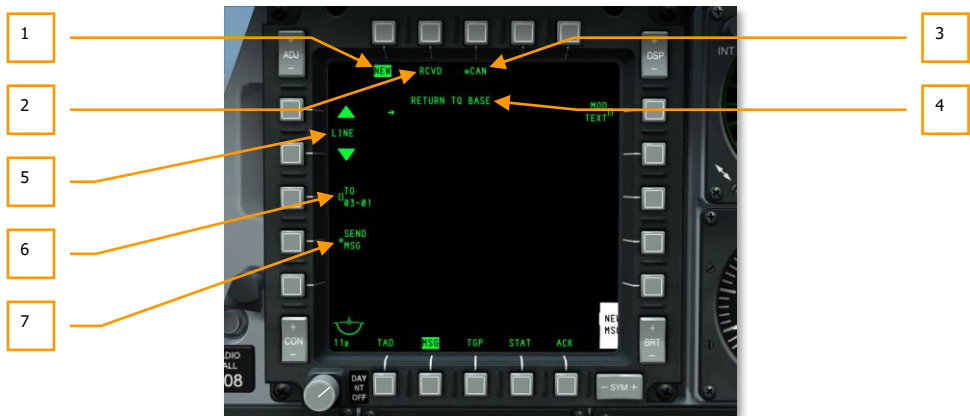

Figure 265. Send Message Page

1. **New Message (NEW)**, OSB 1. The reverse video NEW label indicates that you are in the Send Message Page and that you can send messages to other SA Link-equipped units.
2. **Received Messages (RCVD)**, OSB 2. Pressing the RCVD OSB 2 label directs you to the Received Messages Page. This page allows you to receive and delete text messages from other SA Link-equipped units.
3. **Cancel Message (CAN)**, OSB 3. If you are writing a message and wish to discard it, you can press OSB 3 and erase all contents of your pending message.
4. **Pending Message**. Each message you compose can be up to 10 lines in length with 24 characters each. Left of each line of text is an arrow that can be moved up and down using OSB 19 and 20.
5. **Cycle / Select Line (LINE)**, OSB 19 and OSB 20. Pressing OSB 19 and 20, will cycle through the lines of the pending message. OSB 20 moves the line select arrow up and OSB 19 moves the line select arrow down. The line selected is the one that can be edited.
6. **Message Recipient (TO)**, OSB 18. Here you will determine who the message will be sent to. This is done by entering the SA Link network identification. To do so, enter the network identification in the scratchpad using the CDU or UFC keypads and then press OSB 18. The entered network identification will then be listed below the TO label. This ID will be saved until it is over-written with a new ID. If you wish to send a message to an entire group, you would enter 00 for the ID and then the two-digit group ID. For example: if you wanted to send a message to all aircraft in SA Link network group 12, you would enter 0012.

7. **Send Message (SEND)**, OSB 17. Once a valid network identification has been entered, the SEND MSG label by OSB 17 will be visible. Press OSB 17 to send the message to the selected recipient(s).

Control Display Unit (CDU) Page

The MFCD CDU Repeater page repeats data from the CDU display window and allows you heads-up EGI control using the MFCD controls and UFC.



Figure 266. CDU Repeater Page

OSBs 1–5, 6 and 20 are not operational in CDU repeater mode; OSBs 11–15 operate normally as described in the MFCD section of this document.

Heads Up Display (HUD)

The HUD of the A-10C is used for two primary functions. When the IFFCC switch is in the TEST position, the HUD displays a series of menus that allow you to configure the IFFCC system. These menus are navigated through using the UFC.

- SEL + and – moves the line selection
- DATA cycles a line selection
- ENTER selects the line option selected

When the IFFCC switch is placed in the ON position though, navigation, sensor and weapon information is displayed on the HUD.

IFFCC TEST Menu

When the IFFCC Test option is first selected, the Main Menu page is displayed. This menu allows you access to the four primary selections.

CCIP CONSENT OPT. When CCIP weapon delivery mode is selected, you may select a consent to weapon release constraint (CR) or none. You may cycle between three options:

- **OFF.** No release constraint.
- **3/9.** Release occurs when the CCIP pipper passes past the 3/9 line of the solution cue, even if the solution cue does not intersect with the release pipper.
- **5 MIL.** The pipper must pass through the small 5 mil solution cue.

BIT. The Built in Test (BIT) submenu provides several selections to test IFFCC systems that include:

- **GCAS BIT.** This runs a test of the Ground Collision Alert System (GCAS).
- **VMU BIT.** This runs a test of the Voice Message Unit (Betty).
- **BIT FAULT DISPLAY.** This will perform a test of Line Replaceable Units (LRU).
- **EXIT.** Returns to main Test menu.

AAS. The Air-to-Air Submenu (AAS) allows you to set the air-to-air gun funnel according to 10 pre-set aircraft or create parameters for two aircraft manually.

To select one of the pre-set parameters, move the selection caret to the left of the entry and then press ENTER on the UFC.

To create a manual entry, you can either set a fixed wing entry or a rotary wing entry (MAN-FXD or MAN-RTY). Like the pre-sets, select the entry and press the ENTER button on the UFC. Once selected you have the option to manually set values for:

- Wingspan
- Length
- Target Speed

Once you have made your changes, select STORE from the list or select CANCEL.

WEAPONS. This submenu allows you to select attributes of the 30 mm cannon and weapon aiming offsets.

- **30MM.** The 30 mm gun submenu allows you to select parameters for the GAU-8A gun. Options include:
 - **AMMO TYPE** (Ammunition type). This can be cycled between TP (Training Practice), HEI (High Explosive Incendiary), and CM (Combat Mix).
 - **AMMO MFG** (Ammunition Manufacturer). This can be cycled between OLIN, ALLT and AVE.
 - **PAC1 POS MODE.** Enable or disable PAC1.
 - **MIN ALT.** This value can be set in increments of 100 feet and determines the elevation in reference to the Gun Minimum Range Cue (MRC) on the HUD.
 - **RNDS.** Indication of number of 30mm rounds loaded.
 - **RNDS RESET.** Resets gun round indication to 1150.
 - **STORE.** Save edits and return to main TEST menu.
- **OFFSET ADJUST.** Allows you to adjust aiming offset for the CCIP pipper.
 - **OFFSET ADJ.** Toggles offset adjustment on or off.
 - **GUN RT.** Adjusts the gun pipper delta right (positive) or left (negative), in meters.
 - **GUN UP.** Adjusts the gun pipper delta long (positive) or short (negative), in meters.
 - **BOMB RT.** Adjusts the bomb pipper delta right (positive) or left (negative), in meters.
 - **BOMB UP.** Adjusts the bomb pipper delta long (positive) or short (negative), in meters.
 - **EXIT.** Returns to the previous menu.
- **VAR TGT ELEV.** Sets variable target elevation, in feet. If this value is set to anything other than zero, dual pipper will be shown when the HUD is in CCIP GUNS mode. The bottom and top pipper will be positioned at the minimum and maximum target elevations according to this setting. Use this setting when your targets are spread across uneven terrain.

- **EXIT.** Returns to the main menu.

WPN REL DATA. When a weapon is released, you have the option to display release data parameters on the HUD.

- **AUTO SCROLL.** If YES is selected, all the passes will be automatically scrolled through at a rapid rate for recording on the VTR. After the data pages have been recorded, the first data page will be displayed. If NO is selected, the first data page will be displayed and can be scrolled manually using the UFC ENT key.
- **EXIT.** Return to the main TEST menu.

DISPLAY MODES. This sub-mode allows you to configure how elements of the HUD are displayed.

- **AUTO DATA DISP.** Select Y to briefly display release data on the HUD or N to not display this data.
- **CCIP GUN CROSS OCCULT.** This allows the option to occult the TVV behind the CCIP gun cross in CCIP mode by selecting YES.
- **TAPES.** Set this option to Y to display speed and altitude tapes instead of digital values.
- **METRIC.** Select Y to display HUD data values in Metric. Select N to display in imperial values.
- **RDRALT TAPE.** When enabled to Y, a vertical tape is displayed that indicates the aircraft's radar altitude. The tape ranges from 0 feet at the bottom to 1,500 feet at the top. When above 1,500 feet AGL, the tape is removed. The small horizontal line on the tape indicates the set Altitude Alert Floor setting.
- **AIRSPEED.** Selecting this line allows you to choose how airspeed is displayed on the HUD. Options are TRUE (true airspeed), GS (ground speed), MACH/IAS (MACH and indicated airspeed), and IAS (indicated airspeed).
- **VERT VEL.** Select Y to display a vertical velocity scale on the left side of the HUD.
- **IFF ALERT.** Configures scheduled alerts to remind you of expiring IFF codes.
 - **MODE 1.** Configures an aural and textual "MODE 1" alert. The alert can be dismissed by pressing the UFC ENT key.
 - **START.** The time of day (GMT) when the current mode-1 IFF code expires.
 - **INTERVAL.** The amount of time (HH:MM) to wait between each alert.
 - **MODE 4.** Configures an aural and textual "MODE 4" alert.
 - **START.** The time of day (GMT) when the current mode-4 IFF code expires.
 - **INTERVAL.** The amount of time (HH:MM) to wait between each alert.
 - **EXIT.** Returns to the previous menu.
- **EXIT.** Return to main TEST menu.

MAINTENANCE. The MAINTENANCE submenu is used to verify software version, verify software integrity with a software checksum, and allow ± 15 mils maintenance boresight adjustments to align all dynamic symbols on the HUD. Maintenance adjustments must be done on the ground.

- **SW VERSION.** Indicates the Operational Flight Program (OFP) that the aircraft is using.
- **CHK SUM.** The Checksum (CHK SUM) is a fixed-size data computed from an arbitrary block of digital data for the purpose of detecting errors.
- **BORESIGHT.** Enable ability to manually set HUD symbology boresight on HUD.
- **RT BORESIGHT.** If BORESIGHT is set to Y, this value can be adjusted right.
- **UP BORESIGHT.** If BORESIGHT is set to Y, this value can be adjusted up.
- **EXIT.** Return to main TEST menu.

DELTA CAL. The DELTA CAL submenu allows verification of and adjustments to the delta calibration data.

- **RDR DELTA ALT.** Set radar altitude delta.
- **RDR MSL CAL.** Set radar altitude shifted to MSL.
- **GPS DELTA ALT.** Set GPS delta altitude.
- **GPS MSL CAL.** Set GPS MSL altitude.
- **SELECTED MODE.** Select either GPS or RDR (radar) to set delta calibration for.
- **STORE.** Save entered data.
- **CANCEL.** Cancel entered data and exit to main TEST menu.

GCAS TRAINING. The GCAS TRAINING mode allows the selection and storage of a false ground plane for GCAS training.

- **GND PLANE.** Set the false ground plane by cycling this value: OFF, 2000, or 3000 ft above ground level (AGL).
- **AUTO SCROLL.** Initiates auto scroll menu display for GCAS data capture parameters.
- **STORE.** Saves entered ground plane and exits to main TEST menu.
- **CANCEL.** Sets ground plane to OFF and exits to main TEST menu.

Weapon and Navigation HUD Modes

When the IFFCC switch on the AHCP is placed in the ON position, there are five master HUD modes that you can cycle through using the **Master Mode Control Button** on the control stick.

- **NAV.** Navigation data only with no weapon delivery symbology.
- **GUNS.** Select and display multiple gunsight options.
- **CCIP.** Bombing symbology for Continuously Computed Impact Point delivery including Consent to Release (CR) modes. Maverick delivery also uses the CCIP mode.

- **CCRP.** Bombing symbology for Continuously Computed Release Point delivery for illumination flares, unguided bombs, laser-guided bombs, and Inertially Aided Munitions (IAM).
- **AIR-TO-AIR.** Display symbology for Air-to-Air gun and AIM-9 missile.

NAV HUD

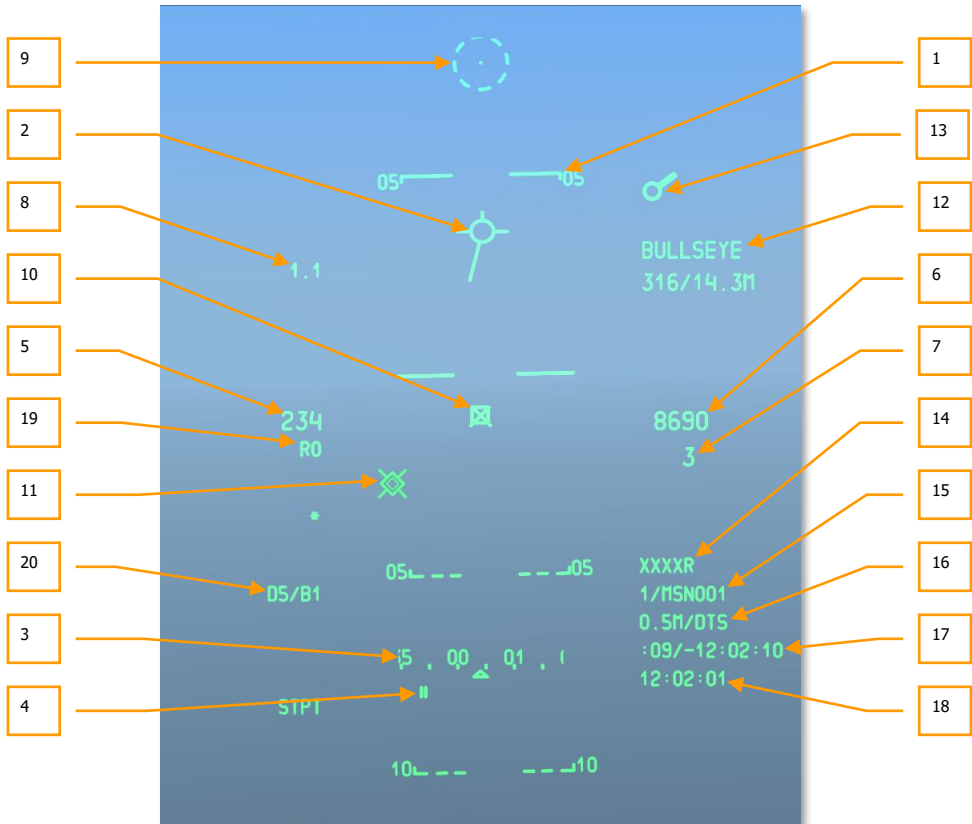

Figure 267. Basic Navigation HUD Symbology

1. **Flight Path Ladder.** The flight path ladder consists of three or four ladder lines that indicate the aircraft flight path angle over a range of $\pm 90^\circ$. The ladder is a tape scale without minor increment marks that moves past the TVV and uses the entire FOV of the HUD for display. The ladder lines are labeled in 5° increments of flight path angle and have tabs at each end pointing toward the horizon line. Dashed lines indicate negative flight path angles, and solid lines indicate positive flight path angles. The flight path ladder also indicates aircraft roll angles of $0^\circ - 360^\circ$ by rotating around the TVV.

2. **Total Velocity Vector (TVV).** The TVV consists of a circle with three lines extending outward from the circumference at the 12, 3, and 9 o'clock positions. The TVV indicates the aircraft inertial velocity vector. At the horizontal limit in the HUD, an arrowhead is displayed at the end of the horizontal line that points toward the computed TVV position. You would most often see this in windy conditions. In CCIP mode, the gun cross will occult the Total Velocity Vector if Y is selected for CCIP GUN OCCULT in the DISPLAY MODES submenu.
3. **Heading Tape / Scratchpad.** The heading tape scale is a tape of increment marks and numerics indicating magnetic heading. A fixed index pointer indicates the magnetic heading. Each mark on the tape represents 5° of magnetic heading, and a 2-digit label is provided at each 10° interval.

When text or numeric data is entered on the UFC or CDU, the scratchpad appears in this area and replaces the heading tape and desired magnetic heading.

4. **Desired Magnetic Heading.** The desired magnetic heading is displayed as 2 vertical lines under the tape at the magnetic heading. It indicates the desired magnetic heading to the selected steerpoint. If the desired heading is off the scale, the desired heading numeric and an arrow are displayed on the side of the shortest turn to the desired magnetic heading.
5. **Airspeed.** Airspeed is displayed as a 3-digit numeric. The airspeed range is 50 to 500 knots. A "T" is displayed to the right of the displayed value for true airspeed, a "G" for ground speed, or no letter for indicated airspeed. The power-on default is indicated airspeed.

The airspeed numeric will flash when the master caution light is activated.

Display options are changed from indicated to true to ground via the IFFCC Test menu.

6. **Barometric Altitude.** The altitude display is in feet and is displayed up to 5 digits. The barometric altitude range is -2,000 to 38,000 feet and is displayed to the nearest 10 feet. In NAV and Air-to-Air modes, the display is the uncorrected CADC barometric altitude. The displayed altitude in these modes should be the same as the cockpit altimeter. In GUNS, CCIP, and CCRP Modes, the displayed altitude is corrected by LASTE for installation errors, non-standard temperatures, and non-standard pressures.
7. **Flight Path Angle.** The flight path angle is displayed below the altitude numeric. A minus sign is displayed for negative values, and positive values are unsigned. The flight path angle has a range of -90° to +90°.
8. **G-Meter.** The Digital G Meter provides a HUD indication of aircraft load factor and is displayed at a fixed point in the top left corner of the HUD. The G value is displayed to the nearest tenth of a G, and ranges from +9.9 to -9.9 G's. If the aircraft load factor exceeds this limit, the displayed value is clamped at the limit.

9. **Depressible Pipper.** The Depressible Pipper/Reticle is a dot at the center of a dashed circle. The circle consists of eight equally spaced dashes and gaps. Using the manual depression control on the UFC, the pipper can be positioned vertically from +10 to -300 mils with respect to the zero sight line, and it is fixed horizontally on the HUD center line and not wind-corrected.

The DEPR rocker switch on the UFC enables the depressible pipper/reticle to be manually depressed over a range of +10 to -300 mils referenced to Zero Sight Line (ZSL).

Individual, momentary depressions of the rocker switch move the applicable pipper up or down one milliradian.

The mil depression of the depressible pipper is displayed over the HUD displayed FOM values while adjusting the pipper and for 3 seconds afterward.

10. **Target Designation Cue (TDC).** The TDC is always displayed when the HUD is the Sensor of Interest (SOI). Initially, the TDC will appear caged within the TVV. The TDC can then be slewed to any location within the HUD Field of View (FOV). When slew is released, the TDC will attempt to compute a position on the ground (latitude, longitude and elevation). If successful, the TDC will ground stabilize on that point. If unsuccessful (location > 13nm away), an "X" will be drawn over the TDC and the TDC will be HUD stabilized with an "X" indicating an invalid designation. In this condition, the TDC cannot become the Sensor Point of Interest (SPI).

Even if the HUD is not SOI, commanding slave to SPI will slave the TDC to the position of the current SPI. The TDC remains slaved until the SPI changes or until the HUD becomes SOI and the Slew Control switch is used to move the TDC.

When the position designated by a ground stabilized TDC is outside the HUD FOV, but within 60 degrees of the aircraft nose, the TDC symbol is clamped to the HUD FOV on the appropriate side of the HUD. If the position is outside the HUD FOV and outside of 60 degrees of the aircraft nose, the TDC is clamped to the HUD FOV and horizontally stabilized to the TVV.

The following HOTAS functions apply when HUD is SOI:

Ground Stabilize (TMS Forward Short). Ground stabilize happens automatically after slewing as long as a position on the ground can be calculated; additionally, while the TDC is still caged within the TVV, this command will attempt to ground stabilize the TDC. If successful, the TDC will ground stabilize on that point. If unsuccessful (location > 13nm away), an "X" will be drawn over the TDC and the TDC will be HUD stabilized with an "X" indicating an invalid designation. If **TMS Forward Short** is selected while the TDC is HUD stabilized with an "X" drawn over it, the TDC will again attempt to establish a position on the ground. If successful, the TDC will ground stabilize; if unsuccessful, the TDC will remain HUD stabilized, with an "X" drawn over the TDC.

Make SPI (TMS Forward Long). This will make the current TDC location the SPI. If **TMS Forward Long** is selected while the TDC is HUD stabilized with an "X" drawn over it, the TDC will attempt to establish a position on the ground. If successful, the TDC will ground stabilize and become the SPI. If unsuccessful (location > 13nm away), the TDC will remain HUD stabilized, with an "X" drawn over the TDC and the TDC will not be made SPI.

Markpoint (TMS Right Short). Create markpoint at TDC line of sight intersection point with ground. This only functions with a valid TDC (no "X" indication).

Reset SPI (TMS Aft Long). When the SPI is reset (HUD Mode or Steerpoint), the TDC remains ground stabilized at its current location.

Recage (China Hat Aft Short). Recages the TDC to TVV. If the TDC was the SPI, the SPI will change to default for the current HUD Mode.

11. **Pave-Penny Cue Index.** The PAVE-PENNY Cue Index is displayed as a dotted line extending from the TVV to the TISL Spider when the Spider is outside the HUD FOV. The dotted line is removed once the target enters the HUD FOV. If the TISL Spider is within the HUD FOV when lock on occurs, the PAVE-PENNY Cue Index appears for 2 seconds and is then removed. The purpose of the index is to provide a method for acquiring the TISL Spider and distinguishing it from the TD Box during maneuvering.
12. **Anchor Point Display.** The HUD Anchor Point display indicates the position of the aircraft relative to the preselected Anchor Point (selected via the CDU Anchor Page). Anchor Point data is displayed in the upper right corner of the HUD anytime an Anchor Point is selected from the Navigation Mode Select Panel. If no Anchor Point is selected, no HUD Anchor Point is displayed.

The HUD Anchor Point display has two lines. The first line displays the waypoint ID of the selected Anchor Point. The second line displays two items separated by a slash (/):

- Magnetic bearing from the Anchor Point to the aircraft (3 characters from 001 to 360).
- Ground range from the aircraft to the Anchor Point.

13. **Destination Index (Tadpole).** The destination index is a circle with a double radial line (strobe) extending out from the circumference. It is displayed when the selected steerpoint is outside the HUD FOV and the steerpoint is not the current SPI. The strobe indicates relative bearing to the selected steerpoint over a range of 0-360 relative to the 12 o'clock position. If the tadpole is not clamped to the HUD FOV limit, the position of the tadpole represents the relative bearing to the selected steerpoint.

14. **Radar Altitude.** The radar altitude numerics consist of 4 digits followed by an "R" and are located on the lower right of the HUD below the altitude. The numerics display altitude to the nearest 10 feet. If the Radar Altitude is invalid or above 5000' AGL, the display is "XXXXR."
15. **Steerpoint Number and ID.** The steerpoint database number and ID are displayed at a fixed position on the lower right side of the HUD FOV. The steerpoint number consists of up to four characters, as provided by the CDU. All mission waypoints are designated 0–50; all navigation waypoints are designated 51–2050; and all markpoints are designated A–Z. The selected steerpoint ID consists of up to 12 alphanumeric characters.
16. **Steerpoint Distance to Go and Target Elevation.** The Steerpoint Distance-to-Go Numeric shows the ground distance to the current steerpoint. The display consists of up to a 4-digit number followed by "M"; when the distance-to-go is less than 10, a decimal point and a tenths digit are displayed. The second half of the line indicates the target elevation at the location of the CCRP reticle.
17. **Time to Go (TTG) and Time on Target Delta (TOT).** These values are used when a set Time on Target (TOT) is created in the CDU and it allows you to better reach your target steerpoint on time. The TTG indicates the estimated time it will take to reach the steerpoint and the TOT estimates the time difference between when you will reach the steerpoint and the TTG. The delta value can be negative or positive.
18. **Current Time / HACK.** This indicates the time in hours:minutes:seconds in regards to GMT.

In addition to the TTG/TOT functionality, this field also serves to display the Hack time. Hack time is a handy way for you to input a time duration on the UFC and then have that time countdown in this field. To do so, select HACK from the UFC and use the keypad to enter a time duration in minutes:seconds (XX:XX). When complete, press the UFC ENTER button and the inputted time will appear in this field and begin counting down. To return to current GMT time, press the HACK button again.
19. **Required Airspeed.** When a Time on Target has been set, this numeric below the airspeed will indicate the airspeed you need to be flying at to reach your steerpoint at the defined time. This field can also display the airspeed Mach value when the IAS/MACH airspeed option is selected from the IFFCC Test Menu.
20. **DTSAS Mode and FOM Message.** This field displays the DTSAS mode and FOM message as set on the EGI CDU.

GUNS HUD

When selecting GUNS mode, you enable the HUD for exclusive use of the gun with multiple gun aiming sights. Symbology and functionality of this HUD includes:

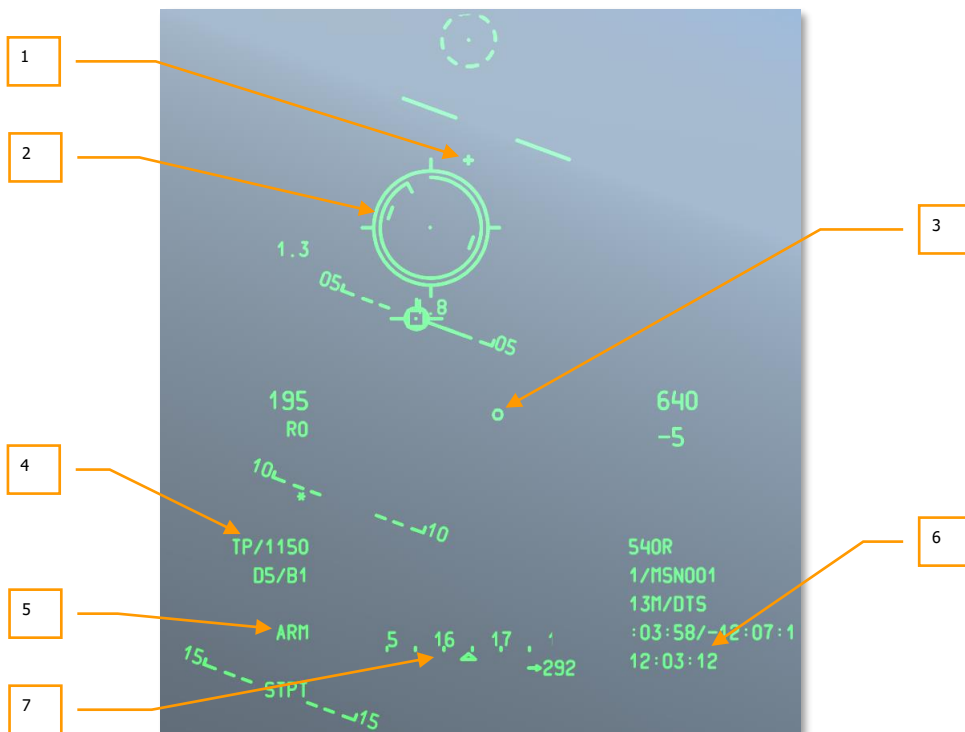

Figure 268. Gun HUD Symbology

1. **Gun Bore Line (GBL) Cross.** This cross represents the longitudinal axis of the 30 mm gun.
2. When in GUNS mode, you may cycle between four different gunsights. These can be cycled using **DMS Left** or **Right Short** when the HUD is SOI.
3. **CCIP Gun Reticle.** The CCIP gun reticle consists of a pipper centered in a reticle. Radial hash marks extend outward from the reticle at the 3, 6, 9, and 12 o'clock positions.

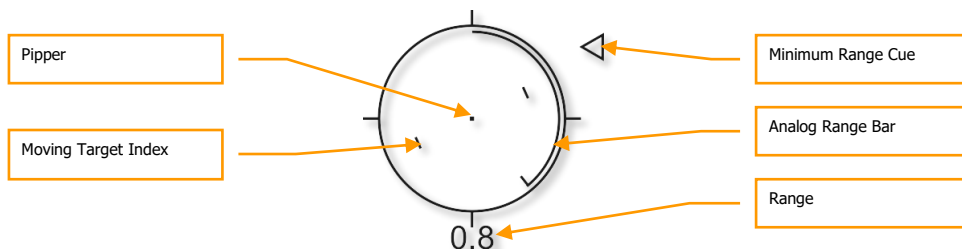

Figure 269. Gun CCIP Reticle

An Analog Range Bar extends around the inside of the reticle clockwise from the 12 o'clock position to a clock position that indicates the range (to the CCIP) in thousands of feet (for example, 5 o'clock = 5,000 feet). A tick marks the end of the analog range bar. For ranges greater than 12,000 feet, the range bar is clamped at 12,000 feet (12 o'clock position).

When CM ammunition load is selected, there will be two pippers in the center of the reticle. The center most one indicates predicted impact point on Armor Piercing (AP) rounds and the one to the lower right is for High Explosive Incendiary (HEI) rounds. The image above shows the reticle with HEI or TP loading.

The 2-digit numeric displays the Range in nautical miles beginning at 0.1 and increasing to 9.9. The numeric then changes to an integer beginning at 10 and increasing to 99.

The reticle contains Moving Target Indices that consist of vertical lines on either side of the pipper. The position represents the lead required for a target moving at 20 knots perpendicular to the LOS. The Moving Target Indices are roll stabilized such that an imaginary line between the vertical lines passing through the pipper remains parallel to the horizon.

An "X" in the middle of the reticle indicates no solution due to lack of an altitude source or the solution is below HUD FOV. In this case, the analog range bar will not be present, no range numeric will be shown, and the reticle will be clamped at a maximum range solution. It will still be roll stabilized and wind corrected.

A Gun Minimum Range Cue (MRC) is a triangle used to calculate a minimum recovery altitude using the minimum altitude from IFFCC 30 MM IFFCC Test Submenu setting.

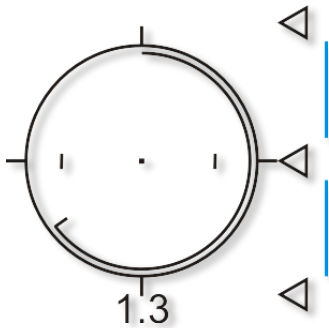

- ← a) Clamped at 5 seconds or more above minimum recovery altitude
- ← b) Aircraft <5 seconds above the minimum recovery altitude
- ← c) Aircraft at the minimum recovery altitude
- ← b) Aircraft <5 seconds below the minimum recovery altitude
- ← a) Clamped at 5 seconds or more below minimum recovery altitude

The three other gunsights include:

CCIP Gun Cross

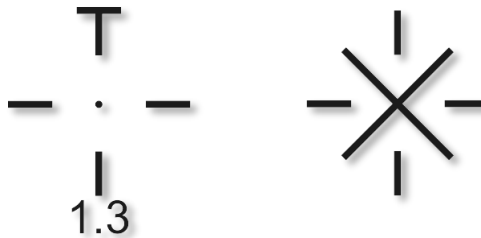

The CCIP gun cross displays the same computed impact point as the CCIP gun reticle, using more compact symbology. A 2-digit numeric displays the range in nautical miles beginning at 0.1 and increasing to 9.9. The numeric then changes to an integer beginning at 10 and increasing to 99.

An "X" in the middle of the cross indicates no solution due to lack of an altitude source or the solution is below HUD FOV. In this case, the horizontal bar will not be present, no range numeric will be shown, and the cross will be clamped at a maximum range solution. It will still be roll stabilized and wind corrected.

A Gun Minimum Range Cue (MRC) is a side triangle used to calculate a minimum recovery altitude using the minimum altitude from IFFCC 30 MM Submenu. This caret also provides the time-to-go indication before aircraft recovery from the gun pass must begin.

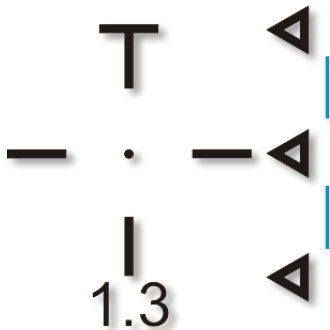

← a) Clamped at 5 seconds or more above minimum recovery altitude

← b) Aircraft <5 seconds above the minimum recovery altitude

← c) Aircraft at the minimum recovery altitude

← b) Aircraft <5 seconds below the minimum recovery altitude

← a) Clamped at 5 seconds or more below minimum recovery altitude

4/8/12 Gun Reticle

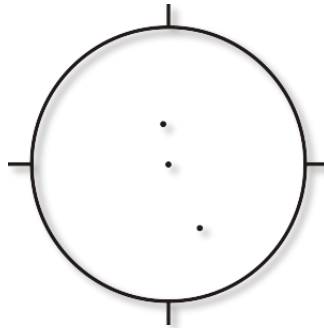

The 4/8/12 Gun Reticle is a degraded mode of the CCIP Gun/Pipper Reticle which displays a reticle with three wind-corrected fixed range pipper representing 4,000-, 8,000-, and 12,000-foot slant ranges and no Analog Range Bar. It is primarily used when inaccurate target elevation information prevents an accurate CCIP solution.

4000-Foot Wind Corrected Gun Cross



The 4000 ft Gun Cross is similar in appearance to the CCIP gun cross, except it has no horizontal bar at the top and no range numeric. It displays a 4,000-foot wind-corrected slant range solution. It is primarily used when inaccurate target elevation information prevents an accurate CCIP solution.

4. **Bullets at Target Altitude (BATA) Circle.** This small circle on the HUD is calculated using CCIP gun ballistics and represents the estimated impact of gun rounds based on time of flight.
5. **Round Type and Remaining Number.** This field indicates the type of gun round loaded (TP, HEI or CM) and the number of rounds remaining. The remaining rounds decrement in increments of 10.
6. **Weapon Status Indicator.** This field is set according to the position of the Master Arm switch on the AHCP. When set to ARM, ARM is indicated in the field. However, if SAFE or TRAIN are selected on the AHCP, these are also indicated on the HUD field.
7. **Current Time / HACK.** This image shows an example of the field in current time mode.
8. **Heading Tape / Scratchpad.** This field displays either the heading tape or the HACK time.

CCIP HUD

When in the CCIP master mode, you are provided symbology and functions to deliver unguided bombs, rockets and the Maverick. For unguided bombs and rockets, you have the option of manual release and Consent to Release (CR).

Bombs

CCIP mode is perhaps the most intuitive means to put a bomb on target and mostly involves placing the "death dot" of the CCIP bombing reticle over the target and releasing the bomb... put the thing on the thing. There are three main ways to release a weapon using CCIP mode and they depend on the setting of the CCIP Consent Option IFFCC Menu item. They are Manual Release, 3/9 Release, and 5 Mil Release.

Manual Release (MAN REL) Bombing Mode

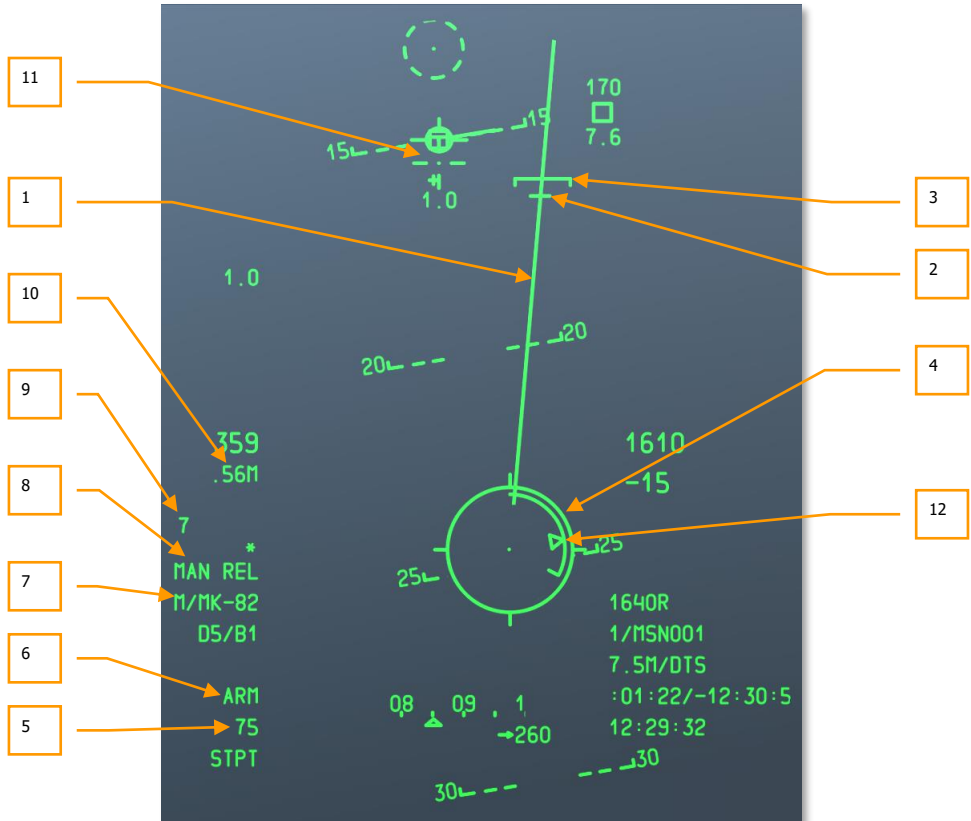

Figure 270. CCIP HUD

1. **Projected Bomb Impact Line (PBIL).** The PBIL is displayed as a line directed outward from the center of the CCIP Reticle. The PBIL is a linear prediction of where the CCIP will track across the ground. It is based upon the assumption that the aircraft will maintain present airspeed, G-load, and bank angle. If the aircraft is maneuvered to track the target down the PBIL, the pipper can be guided directly to the target even at high bank angles. If a ripple release is selected, the bomb stick will fall along the PBIL and the displayed CCIP solution is for the center of the bomb stick length.

Be mindful of erratic roll changes in CCIP or the PBIL can move from side to side on the HUD in a "windshield wiper effect".

2. **Desired Release Cue (DRC).** The DRC is a small line on the PBIL and represents the desired time of fall as entered in the DSMS weapon profile (DES TOF). The DRC serves as a guide in setting up proper aim off distance for the subsequent delivery. The aircraft should be maneuvered to place the DRC on the target. If the DRC is on the target, and a constant bank angle and load factor are maintained, the DRC will move down the PBIL at the same rate as the actual target, and the CCIP will be coincident with the target just as the weapon time of fall matches the menu entry.

An X is displayed over the DRC when current parameters indicate the CCIP will not appear on the HUD prior to desired time of fall.

The DRC may be below the MRS during instances when the aircraft flight parameters vary widely from the desired weapons event. This will most likely occur when the dive angle is much greater than the planned event.

For ripple deliveries, the DRC indicates the release point, so that the middle bomb of a stick falls at the point of desired impact. If an even number of bombs is selected, the center bombs will bracket the target.

DRC will not be displayed until aircraft flight path is -3° and below.

3. **Minimum Range Staple (MRS).** This staple on the PBIL indicates the set minimum escape range of the selected profile as set in DSMS. This staple will indicate the minimum release range according to altitude (MIN ALT), fuze setting, or Height of Function (HOF) for cluster bombs. In order to release the weapon above the minimum set altitude, the CCIP reticle should always be below the MRS. If the MRS falls down the PBIL and reaches the CCIP bomb reticle, a large X will be displayed in the center of the reticle to indicate an invalid release.
4. **CCIP Bomb Reticle.** The CCIP bombing reticle consists of a pipper centered in a reticle. Radial hash marks extend outward from the reticle at the 3, 6, 9, and 12 o'clock positions.

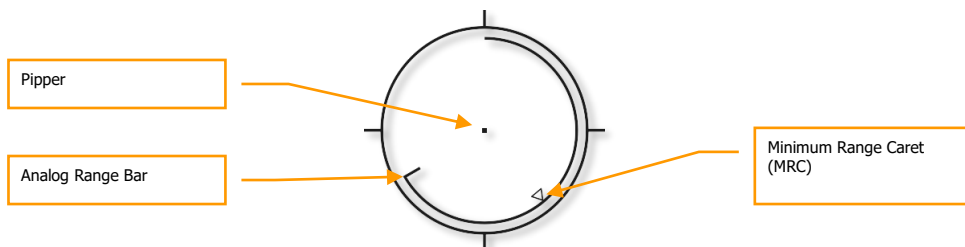

Figure 271. CCIP Bombing Reticle

An Analog Range Bar extends around the inside of the reticle clockwise from the 12 o'clock position to a clock position that indicates the range (to the CCIP) in thousands of feet (for example, 5 o'clock = 5,000 feet). A tick marks the end of the analog range bar. For ranges greater than 12,000 feet, the range bar is clamped at 12 o'clock position).

An "X" in the middle of the reticle indicates the aircraft is below the set Minimum Range (MRS/MRC) altitude.

5. **Selected Stations.** When a profile is selected, the weapon stations with the associated profile store are indicated in this field as a number string. For example: 8475 indicates that bombs are hung on weapon stations 8, 4, 7 and 5.
6. **Weapon Status Indicator.** This field is set according to the position of the Master Arm switch on the AHCP, and ARM, TRAIN, or SAFE will be indicated on the HUD field accordingly.
7. **Profile Name.** Name of the active profile. Note that you can create multiple profiles for the same weapon type with different release parameters.
8. **Release Mode.** Selected weapon release mode. When in Manual release mode, this field will indicate MAN REL. Manual release is selected by default, but can be changed in the IFFCC Test Menu, CCIP Consent menu between OFF (Manual), 3/9 and 5 MIL.
9. **Time-Of-Fall Display.** Once the weapon has been released, this numeric will count down in seconds until weapon impact at time 0. After reaching 0, the numeric will flash.
10. **Mach Airspeed Indication.** When the IFFCC Test Menu, Display Airspeed option is set to MACH/IAS, the Mach number will be displayed in this field.
11. **CCIP Gun Cross.** In addition to the CCIP bombing reticle, the CCIP gun cross is also displayed and acts as described in the GUNS Mode section of this chapter.

12. **Minimum Range Caret (MRC).** This caret placed on the analog range bar indicates the set minimum escape range of the selected profile. This caret will indicate the minimum release range according to altitude (MIN ALT), fuze setting, or Height of Function (HOF) for cluster bombs.

3/9 Release and 5 Mil Consent to Release (CR) Bombing Modes

Both the 3/9 and 5 Mil options use what is termed Consent to Release (CR). The only difference between the two is how accurately you must have the pipper pass through the solution cue to release the bomb. The advantage of using CR is that you may designate a target point and then pull-up and release the bomb in a non-diving attack. This gives you the option of wings-level bombing and toss bombing depending on the attitude of the aircraft at weapon release. Much of the HUD remains the same as the Manual Release mode, but with the following changes:

Pre-Designate. This is how the HUD will generally look in CCIP CR bombing mode prior to designating the target point.

2. **CCIP Bomb Reticle.** When the CCIP reticle is outside the HUD FOV, it will be dashed like the PBIL. However, with the CCIP Bomb Reticle clamped to the bottom of the HUD FOV, you can use the center pipper to designate the target spot for a CR delivery. To do so, maneuver the aircraft to place the pipper over the target and then hold down the **weapon release button**. This will put the HUD into the post-designate mode.
3. **Pre-designate TTRN.** The Time to Release Numeric (TTRN) in the CCIP bomb reticle indicates the time in seconds it would take to release the bomb in post-designate mode if you were to designate the location under the pipper now.
4. **Release Mode.** Selected weapon release mode. This will indicate either 3/9 or 5 MIL when you select one of these two CR modes from the IFFCC Test Menu, CCIP Consent menu.

Post-Designate. This is how the HUD will generally look in CCIP CR bombing mode after designating the target point by placing the pipper over the target and then holding down the weapon release button.

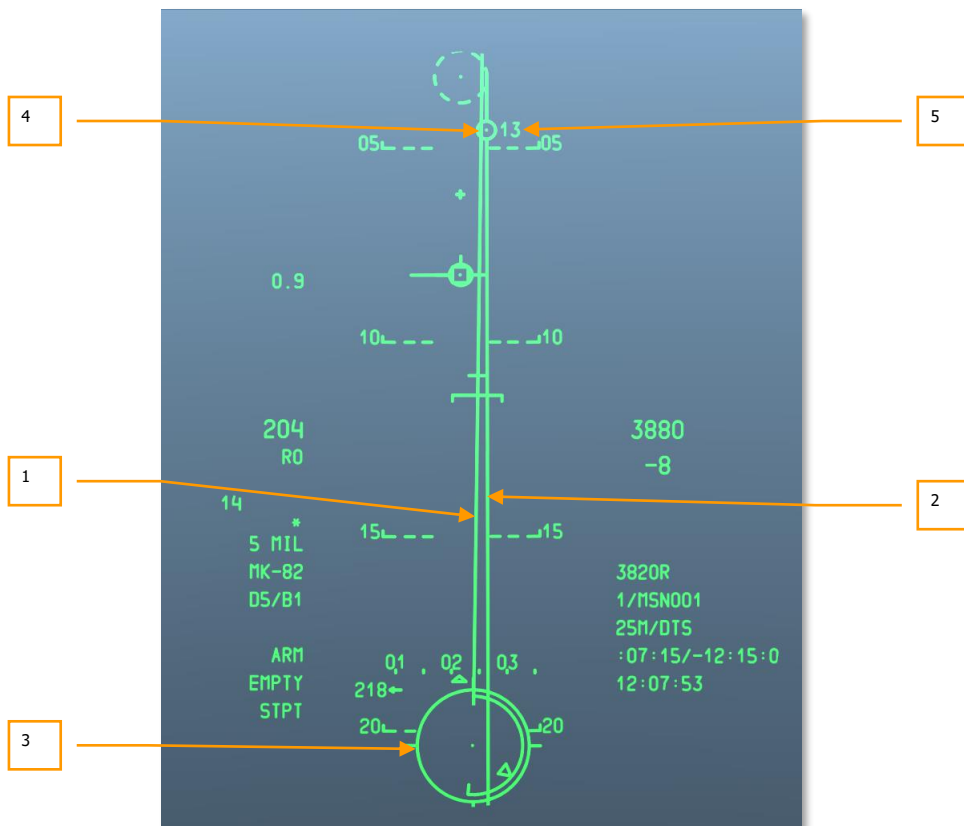

Figure 273. CCIP CR HUD, Designate HUD

1. **Projected Bomb Impact Line (PBIL).** With the target designated, the PBIL will turn from dashed to solid.
2. **Azimuth Steering Line (ASL).** Once you have designated the target, the ASL will appear on the HUD and provide you azimuth steering towards the designated target.
3. **CCIP Bomb Reticle.** Once designated, the CCIP bomb reticle will turn from dashed to solid and provide additional information.

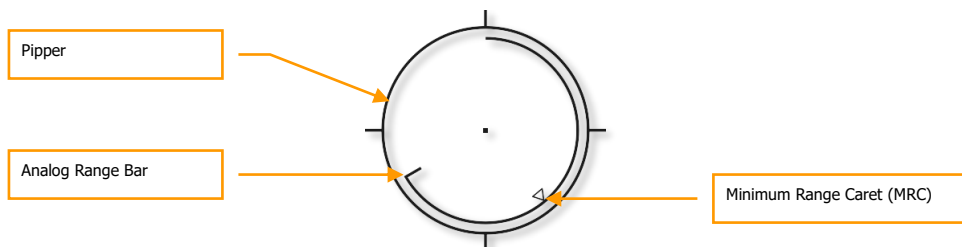

Figure 274. CCIP CR Reticle

An Analog Range Bar extends around the inside of the reticle clockwise from the 12 o'clock position to a clock position that indicates the range (to the CCIP) in thousands of feet (for example, 5 o'clock = 5,000 feet). A tick marks the end of the analog range bar. For ranges greater than 12,000 feet, the range bar is clamped at 12 o'clock position).

An "X" in the middle of the reticle indicates the aircraft is below the set Minimum Range (MRS/MRC) altitude.

4. **Solution Cue.** This is a 5-mil circle with a dot in the center placed on the ASL and indicates when the weapon will be released. While still holding down the **weapon release button**, you must maneuver the aircraft to place the CCIP bomb reticle pipper inside the solution cue (5 Mil) or place the solution cue anywhere within the CCIP bomb reticle (3/9). If done correctly and still holding down the **weapon release button**, the weapon will drop automatically on the designated target location. If the azimuth steering error becomes too great, an X will be drawn in the solution cue to indicate an invalid release condition.

Below is an example of a successful 5 MIL CR with the solution cue and CCIP bomb pipper overlaid correctly.



Figure 275. CCIP CR Release Sight Picture

5. **Time to Release Numeric (TTRN).** The TTRN is a timer that counts down in seconds to the moment of weapon release. If you release the **weapon release button** early, the weapon release process will be cancelled.

For further details regarding CCIP Bomb delivery, please consult the Combat Employment chapter.

Rockets

Launching unguided rockets in CCIP uses a combination of GUNS and CCIP bomb functions. When in CCIP mode, rockets can only be fired in Manual release mode and not in CR mode.

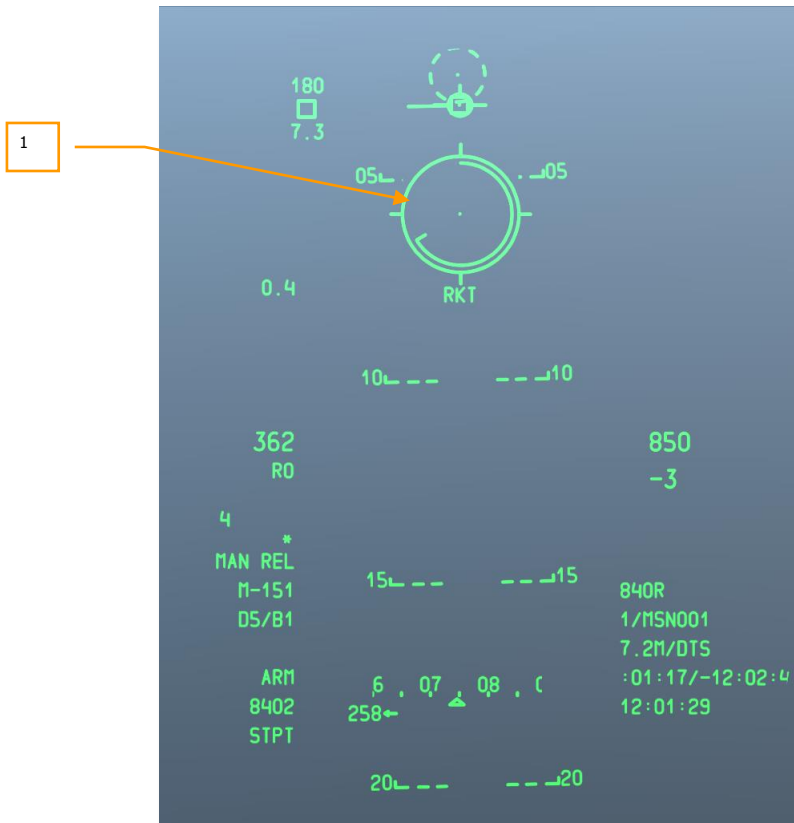

Figure 276. CCIP Rocket HUD

1. **Rocket CCIP Reticle.** This CCIP reticle is much like the Guns CCIP reticle but minus the Gun Minimum Range Cue (MRC) and Moving Target Indices. Below the reticle are two text fields. The top field always displays RKT (rocket), and the lower field indicates the slant range along the pipper line of sight.

For further details regarding CCIP rocket delivery, please consult the Combat Employment chapter.

Maverick

In conjunction with the MFCD Maverick page, the CCIP Maverick HUD mode provides cuing for all versions of the AGM-65. Much of the Maverick HUD uses symbology of other CCIP HUD modes with the exception of the Dynamic Launch Zone (DLZ) and Maverick reticle.

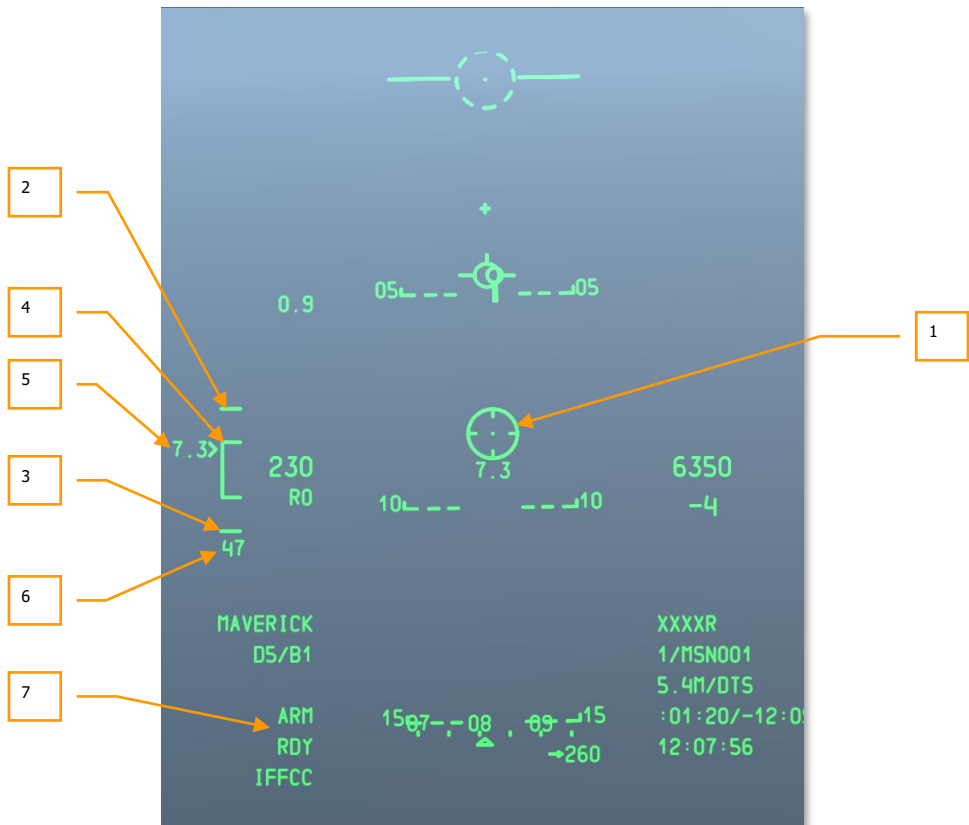

Figure 277. CCIP Maverick HUD

1. **Maverick Reticle.** The Maverick "Wagon Wheel" reticle displays the missile's line of sight and will match the Maverick video displayed on the Maverick MFCD page. When line of sight range is less than the minimum range, an X will be overlaid on the reticle and a launch will be inhibited. When the Maverick is slewed or locked to a target outside the HUD field of view, the reticle will

be clamped to the side of the HUD in the direction of the line-of-sight point and flashing. The line-of-sight range is displayed below the reticle.

2. **Upper Tick Mark.** This tick mark at the top of the DLZ staple represents the Maverick's maximum range. It is fixed at 15 nm.
3. **Lower Tick Mark.** This tick mark at the bottom of the DLZ staple represents the Maverick's minimum range. When the Target Range Caret reaches this tick, the Maverick Reticle will have an X overlaid.
4. **DLZ Range Staple.** The Dynamic Launch Zone (DLZ) staple displays the dynamic inner portion of the launch zone. The DLZ will be visible as long as the active Maverick is locked to a target within 30° off the nose of the aircraft. The Target Range Caret will move vertically along the staple to indicate range and range will be dynamic according to factors such as altitude and airspeed.
5. **Target Range Caret and Numeric.** This caret and range numeric to the left moves vertically up and down the DLZ and indicates slant range from the aircraft to the line of sight point of the Maverick.
6. **Missile Time of Flight.** Once the Maverick has been launched, the Time-of-Flight counter will appear at the bottom of the DLZ and will count down in seconds to estimated missile impact. After reaching 0, the numeric will flash.
7. **Weapon Status.** When a Maverick has been locked onto a target, the station number that the active Maverick is loaded on will be displayed on the left side of this field. On the right side of the field the status of the Maverick is displayed. There are three possibilities:
 - **ALN.** The Maverick is in the process of its three-minute gyro alignment.
 - **RDY.** The Maverick has been aligned and is ready for use.
 - **EMPTY.** All Mavericks of the selected profile have been expended.

For further details regarding Maverick delivery and background, please consult the Combat Employment chapter and Maverick Chapter.

CCRP HUD

Unlike CCIP manual and CR modes, the Continuously Calculated Release Point (CCRP) mode allows you to set an aimpoint other than placing the pipper directly on the target first. For example: using the TDC, TGP or Maverick you can create a SPI and use CCRP mode to drop a bomb or rocket on the designated SPI-located target.

Much of the CCRP symbology is identical to CCIP in CR mode, but you will generally have much longer TTRN times, depending on the distance to the designated target SPI point.

When releasing laser-guided bombs, the release mode will only allow 3/9 mode.

In addition to releasing free-fall bombs and illumination flares, CCRP can also be used to deliver rockets in a lofting manner.

Unlike CCIP, CCRP mode does not include the CCIP gun cross.

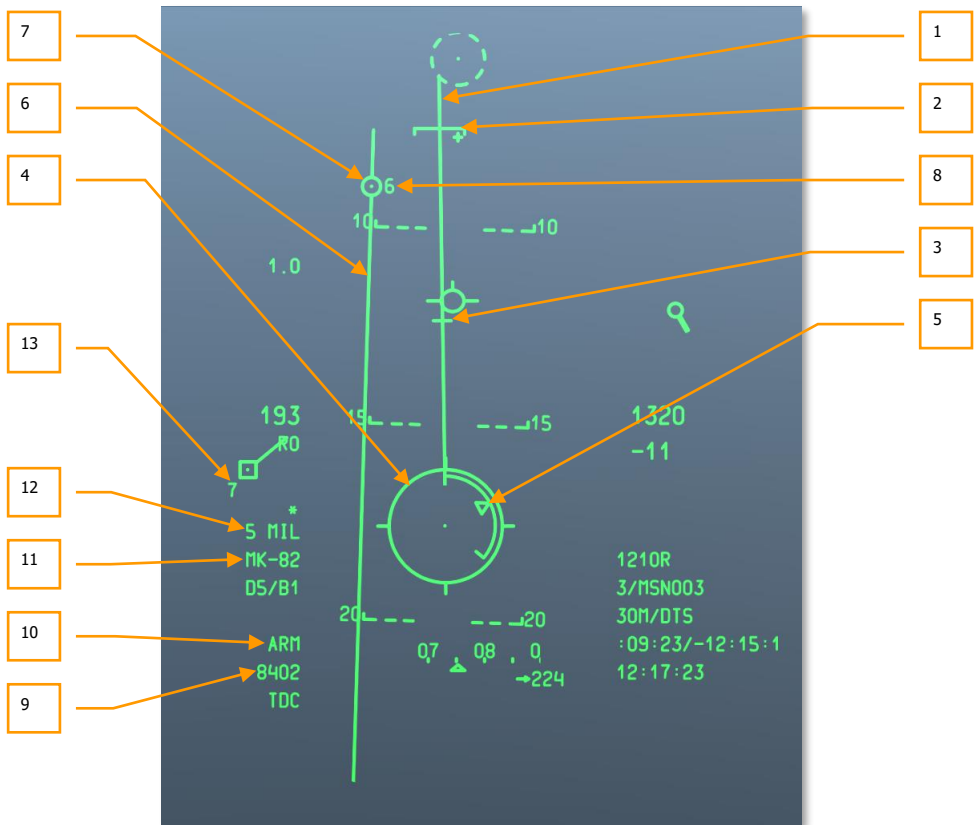

Figure 278. CCRP HUD

1. **Projected Bomb Release Line (PBRL).** The PBRL is displayed as a line directed outward from the center of the CCRP reticle. The PBRL is a linear prediction of where the CCRP will track across the ground. It is based upon the assumption that the aircraft will maintain present airspeed, G-load, and bank angle. If the aircraft is maneuvered to track the target down the PBRL, the piper can be guided directly to the target even at high bank angles. If a ripple release is selected, the bomb stick will fall along the PBRL and the displayed CCRP solution is for the center of the bomb stick length.
2. **Minimum Range Staple (MRS).** This staple on the PBIL indicates the minimum escape range of the selected profile. This staple will indicate the minimum release range according to altitude

(MIN ALT), fuze setting, or Height of Function (HOF) for cluster bombs. In order to release the weapon above the minimum set altitude, the CCRP reticle should always be below the MRS. If the MRS falls down the PBIL and reaches the CCRP bomb reticle, a large X will be displayed in the center of the reticle to indicate an invalid release.

3. **Desired Release Cue (DRC).** The DRC is a small line on the PBIL and represents the desired time of fall as entered in the DSMS weapon profile (DES TOF). The DRC serves as a guide in setting up proper aim off distance for the subsequent delivery. The aircraft should be maneuvered to place the DRC on the target. If the DRC is on the target, and a constant bank angle and load factor are maintained, the DRC will move down the PBIL at the same rate as the actual target, and the CCRP will be coincident with the target just as the weapon time of fall matches the menu entry.

An X is displayed over the DRC when current parameters indicate the CCRP will not appear on the HUD prior to desired time of fall.

The DRC may be below the MRS during instances when the aircraft flight parameters vary widely from the desired weapons event. This will most likely occur when the dive angle is much greater than the planned event.

For ripple deliveries, the DRC indicates the release point, so that the middle bomb of a stick falls at the point of desired impact. If an even number of bombs is selected, the center bombs will bracket the target.

DRC will not be displayed until aircraft flight path is -3 degrees and below.

4. **CCRP Bomb Reticle.** The CCRP reticle acts much like the CCIP reticle but is used in conjunction with the Solution Cue to indicate the release point (CCRP bomb reticle and Solution Cue coincide).

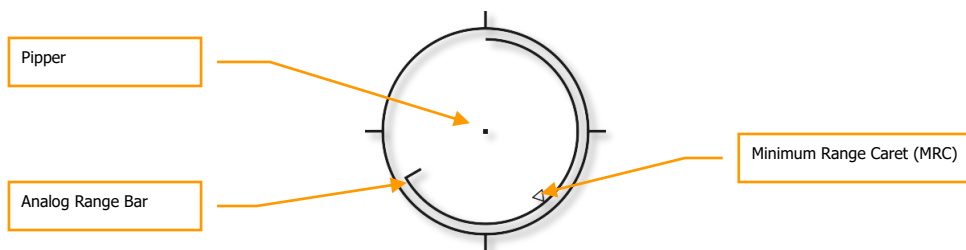

Figure 279. CCRP Reticle

An Analog Range Bar extends around the inside of the reticle clockwise from the 12 o'clock position to a clock position that indicates the range (to the CCRP) in thousands of feet (for example, 5 o'clock = 5,000 feet). A tick marks the end of the analog range bar. For ranges greater than 12,000 feet, the range bar is clamped at 12,000 feet (12 o'clock position).

An "X" in the middle of the reticle indicates the aircraft is below the set Minimum Range (MRS/MRC) altitude.

5. **Minimum Range Caret (MRC).** This caret placed on the analog range bar indicates the set minimum escape range of the selected profile. This caret will indicate the minimum release range according to altitude (MIN ALT), fuze setting, or Height of Function (HOF) for cluster bombs.
6. **Azimuth Steering Line (ASL).** Once you have designated the target, the ASL will appear on the HUD and provide you azimuth steering directions towards the designated target.
7. **Solution Cue.** This is a 5-mil circle with a dot in the center placed on the ASL and indicates when the weapon will be released. While still holding down the **weapon release button**, you must maneuver the aircraft to place the CCRP bomb reticle pipper inside the solution cue (5 Mil) or place the solution cue anywhere within the CCRP bomb reticle (3/9). If done correctly and still holding down the **weapon release button**, the weapon will drop automatically on the designated target location. If the azimuth steering error becomes too great though, an X will be drawn in the solution cue to indicate an invalid release condition.

Below is an example of a successful 5 MIL CR with the solution cue and CCRP bomb pipper overlaid correctly.

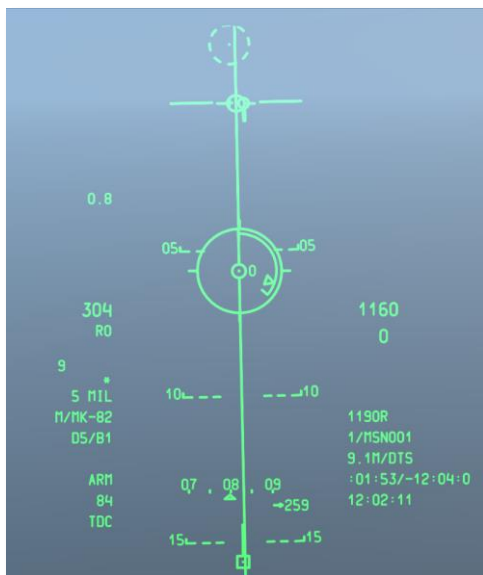

Figure 280. CCRP HUD Release Sight Picture

8. **Time to Release Numeric (TTRN).** The TTRN is a timer that counts down in seconds to the moment of weapon release. If you release the **weapon release button** early, the weapon release process will be cancelled.
9. **Selected Stations.** When a profile is selected, the weapon stations with the profile store are indicated in this field as a number string. For example: 8402 indicates that bombs are hung on weapon stations 8, 4, 10 and 2.
10. **Weapon Status Indicator.** This field is set according to the position of the Master Arm switch on the AHCP, and ARM, TRAIN, or SAFE will be indicated on the HUD field accordingly.
11. **Profile Name.** Name of the active profile. Note that you can create multiple profiles for the same weapon type with different release parameters.
12. **Release Mode.** Selected weapon release mode. This will indicate either 3/9 or 5 MIL when you select one of these two CR modes from the IFFCC Test, CCIP Consent menu.
13. **Time-Of-Fall Display.** Once the weapon has been released, this numeric will count down in seconds until weapon impact at time 0. After reaching 0, the numeric will flash.

CCRP Inertial Aided Munition (IAM) HUD

When an IAM weapon profile has been called up, the CCRP HUD will display a sub-version that allows you to release IAM weapons such as Joint Direct Attack Munition (JDAM) GBU-31 and GBU-38 and CBU-103 Wind Corrected Munition Dispenser (WCMD). These weapons rely on GPS- and INS-guidance to accurately hit their targets and require no guidance support from the aircraft once they are dropped. IAM weapons target the SPI.

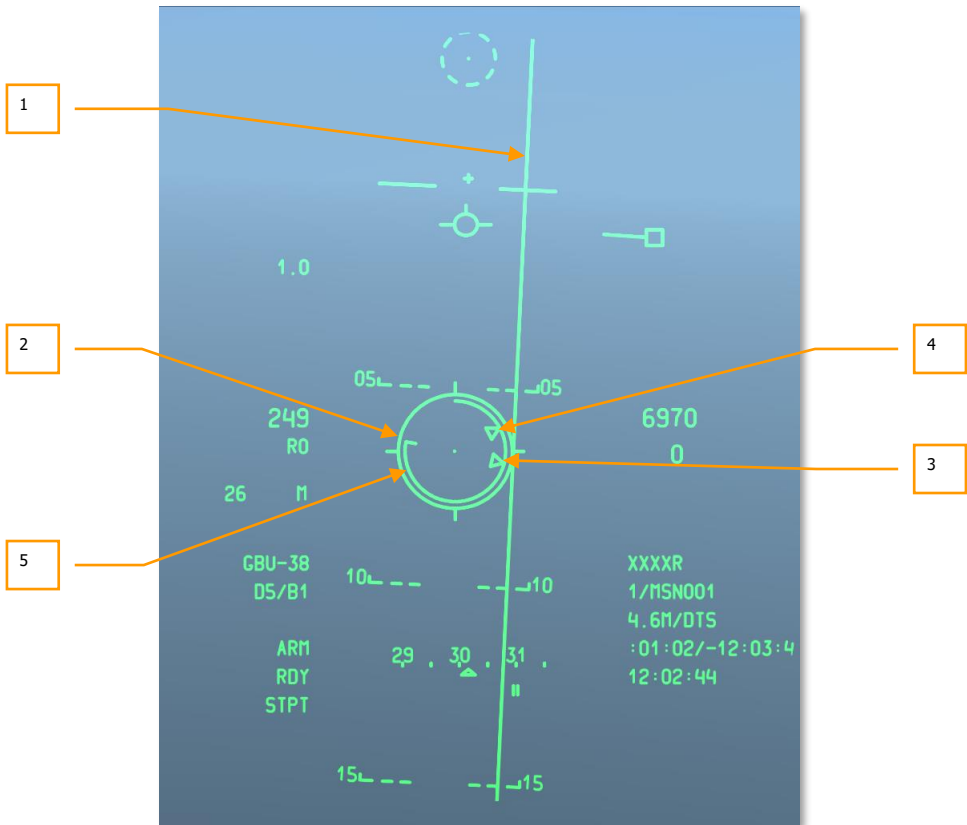

Figure 281. CCRP IAM HUD

1. **Azimuth Steering Line (ASL).** As with the standard CCRP ASL, this vertical line is centered on the heading you need to fly to reach the SPI. However, unlike the standard CCRP ASL, there is no solution cue.
2. **CCRP Reticle.** In the CCRP IAM sub-mode, the reticle remains “attached” below the TVV and moves with the TVV according to aircraft maneuvering. In order to deliver an IAM weapon, you need to fly the aircraft to align the reticle over the ASL line.
3. **Maximum Range Caret.** Within the reticle is the maximum range caret. This indicates the maximum range at which you may release the IAM weapon and still hit the target / SPI location. Aircraft altitude and speed will determine the maximum range of the weapon.
4. **Minimum Range Caret.** Within the reticle is the minimum range caret. This indicates the minimum range at which you may release the weapon and still hit the target. Aircraft altitude and speed will determine the minimum range of the weapon.
5. **Release Cue.** Within the reticle is a line that indicates the weapon release cue. When the line is between the minimum and maximum range carets, you may release the weapon. When in range, MAN REL is displayed in the weapon status field on the HUD.

For more details on CCRP bomb delivery, please refer to the Combat Employment chapter.

Air-to-Air HUD

For air-to-air combat in the A-10C you can employ both the 30 mm cannon and the AIM-9M Sidewinder air-to-air missile with unique HUD symbology. Unlike NAV, GUNS, CCIP and CCRP which you access by cycling the Master Mode Button, you hold down the Master Mode Button to bring up the air-to-air HUD. The two primary, unique components of the air-to-air HUD include the gun funnel and the AIM-9 seeker reticle.

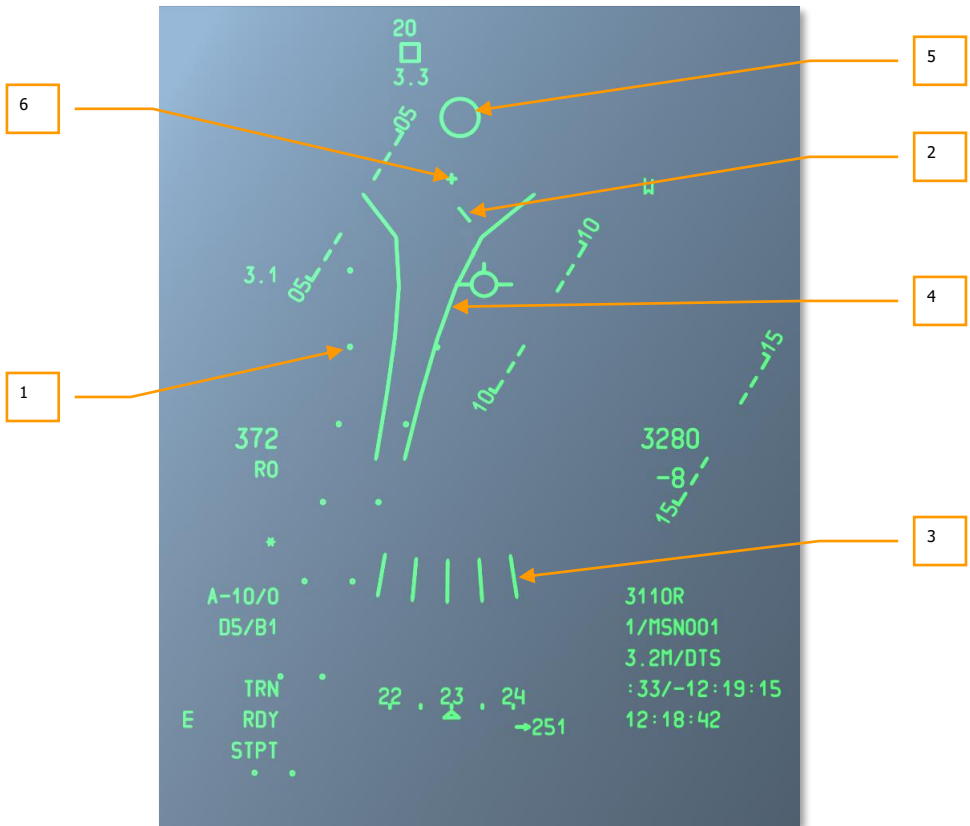

Figure 282. Air-to-Air HUD Symbology

- 1. Firing Evaluation Display System (FEDS).** The FEDS display consists of 2 electronic tracer streams separated by target wingspan. The streams are displayed when the gun trigger is

depressed to the second detent with the Master ARM in TRAIN and it continues as long as the trigger is depressed. FEDS projects out to a 2 second TOF.

The FEDS algorithm is inhibited while LAAP is engaged.

2. **Air Mass Impact Line (AMIL).** The AMIL display is a vertical line which represents the lead angle due to trajectory shift and gravity drop of rounds from close range out to approximately 2 seconds time of flight. The AMIL is displayed toward the top of the HUD, pointing towards the GBL cross and the surface of the earth. The top of the AMIL shows where the bullets will be just after the firing burst and the distance they will fall towards the earth after 2 seconds due to deceleration and gravity drop.
3. **Multiple Reference Gunsight (MRGS).** The MRGS sight is composed of a series of five line segments pointing toward the Gun Bore Line, and spaced in an arc near the bottom of the HUD. The multiple lines represent multiple solutions for a target. MRGS lines continually collapse to the aircraft plane of motion. As each line reaches the plane of motion, it disappears, and a new line is placed on the outside of the arc. The length of each line represents the preset target length and is used as a reference for target ranging.

The MRGS is used by positioning the target parallel to one of the lines. The size and depression of the MRGS is determined by the fuselage length and airspeed data entered into the IFFCC AAS submenu. The lines are spaced at a distance from the GBL corresponding to $\frac{1}{2}$ the input target velocity.

When using an MRGS line, if the target is smaller than the line, it is either out of range or moving faster than anticipated and requires extra lead. If the target is larger than the MRGS line, the target is moving slower than anticipated and will require less lead.

4. **Funnel Gunsight.** The funnel display uses stadiametric ranging based on preset target wingspan set in the IFFCC menu Air-to-Air Submenu (AAS) page. The IFFCC computer assumes the actual target wingspan is exactly what has been entered into the AAS submenu, the attacker and target are co-air-speed, and the target angular tracking rate through the HUD is zero. Whenever aircraft flight parameters change, the funnel will move and shift as the IFFCC calculates and displays new targeting solutions.

As the range decreases, the target size will increase. As this occurs, you must place the target higher in the funnel in order to keep the target wingspan just touching the sides of the funnel. This results in placing the target higher in the HUD or, more importantly, closer to the GBL which results in reduced lead for the reduced range.

5. **AIM-9 Seeker Reticle.** The AIM-9 seeker circle is a small circle that indicates the position of the AIM-9 seeker head. The AIM-9 is employed by slewing the HUD AIM-9 symbol over a target or by maneuvering the aircraft to line up the target with the AIM-9 symbol. If the missile detects

sufficient IR energy from the target, target detection is indicated by an audio missile detection tone (growling sound) and the symbol latches to the target.

The following HOTAS functions apply when HUD is SOI in Air-to-Air Mode with AIM-9 selected:

Track (TMS Forward Short): The first depression enters scan mode which allows AIM-9 slewing. The next depression commands circular scan and consent to self-track, which activates a circular scan pattern and automatically grants tracking if a target of sufficient IR energy is detected. Repeated presses toggle between scan mode and circular scan/consent to self-track.

Breaklock (TMS Aft Short): If the seeker is uncaged (whether tracking or not tracking a target), commands the seeker back to boresight.

Slew (Slew Control): Slews the AIM-9 seeker. When slew is released, AIM-9 has consent to track target.

Uncage Missile (China Hat Forward Short): Commands missile track if the seeker is caged. The seeker will track if IR intensity is strong enough; otherwise, the seeker will start to drift and will need to be recaged. This is a useful function to confirm a good lock.

Missile Reject (China Hat Aft Short): First HOTAS Reject command will recage the missile to boresight. Subsequent HOTAS Reject takes the missile out of service. If all missiles are rejected, the system will return them all to active status.

Slave to TGP (China Hat Forward Long): Slaves missile to the TGP line of sight. This is a useful function when you have locked an air target in TGP air-to-air mode and want to slew the AIM-9 seeker to that target.

Weapons Release (Weapon Release Button): Fires AIM-9. AIM-9 seeker disappears after shot. If another AIM-9 is available and ready, a new seeker reappears after the first shot.

6. **Gun Bore Line (GBL) Cross.** This cross indicates the boresight line of sight of the longitudinal axis of the 30 mm gun.

For more details on air-to-air HUD, please reference the Combat Employment chapter.

SPI and Hookship Symbols

SPI HUD Symbols

At all times there will be a SPI. By default, it will be your steerpoint, but you can also manually set it by use of the TDC, TAD cursor, TGP, gun reticle or Maverick LOS. The SPI symbology on the HUD helps you locate the SPI and bring it into your HUD field of view.

The active SPI point is indicated by a line extending from either the Total Velocity Vector (TVV) or line of sight symbol.

When the SPI location is inside the HUD field of view, a line will extend from the SPI point towards the TVV.

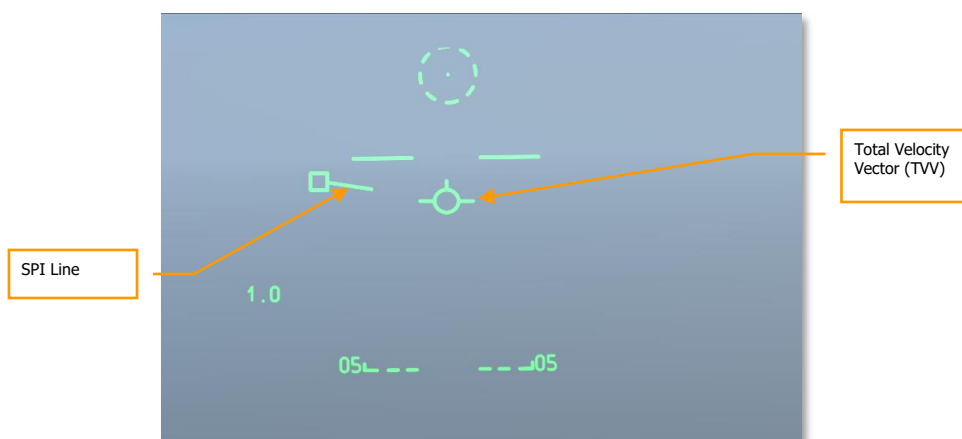

Figure 283. TDC as SPI within HUD FOV

However, when the SPI point lays outside the HUD field of view, it is reversed. The SPI line will extend from the TVV towards the direction of the SPI point. The SPI point will be clamped to the side of the HUD nearest the direction of travel and the bearing towards the SPI will be marked above the symbol and the range to the SPI below the symbol. The symbol that is attached to the SPI line will depend on the sensor that was used to designate the SPI. For example, below is a case of the TDC designating the SPI. If the symbol was a diamond, it would indicate the TGP set the SPI.

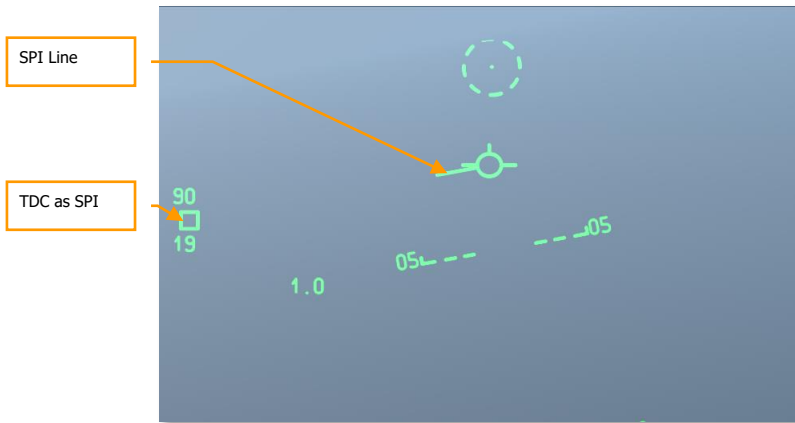

Figure 284. TDC as SPI outside HUD FOV

In the above case, the SPI was set by the TDC and is 90 degrees to the left and 19 nm away.

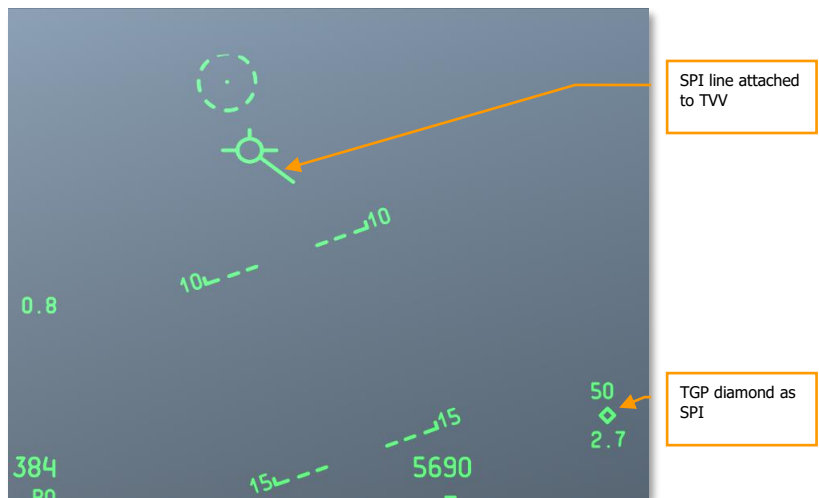

Figure 285. TGP as SPI outside HUD FOV

In the above case, the SPI was set by the TGP and is 50 degrees to the right and 2.7 nm away.

Hookship HUD Symbols

Using the TAD, you may hook a TAD symbol (object) with a **TMS Forward Short** command. This hooks the symbol on the TAD but also on the HUD. At the location of the hooked symbol (may be a static location or attached to a moving unit), a dashed box is displayed. If the hooked object is outside the HUD field of view, it will be clamped to the side of the HUD. Additionally, two parallel, dashed lines will extend from the TVV towards the Hookship box.

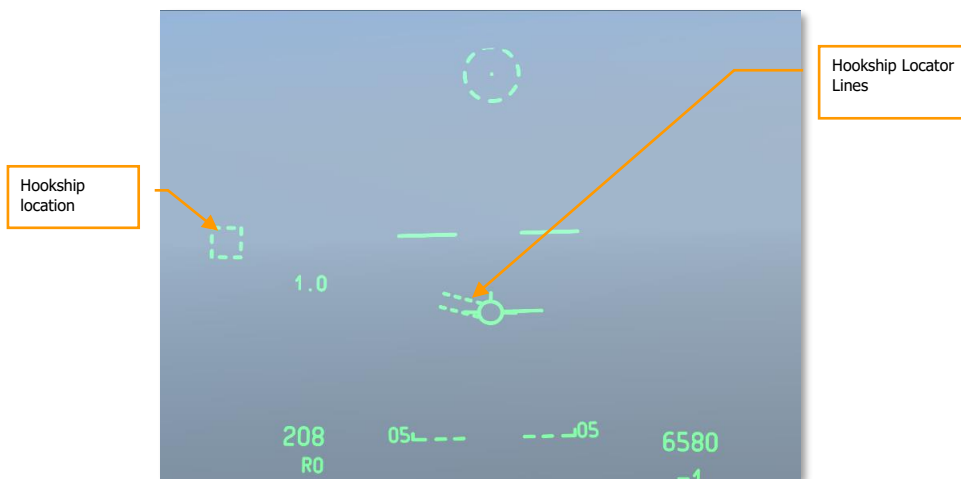

Figure 286. Hookship within HUD FOV

By setting SPI and Hookship to different objects/locations, you can display both SPI and Hookship symbols on the HUD at the same time. You can also first hook an object and then set it as SPI and have both SPI and Hookship symbols attached to the object.

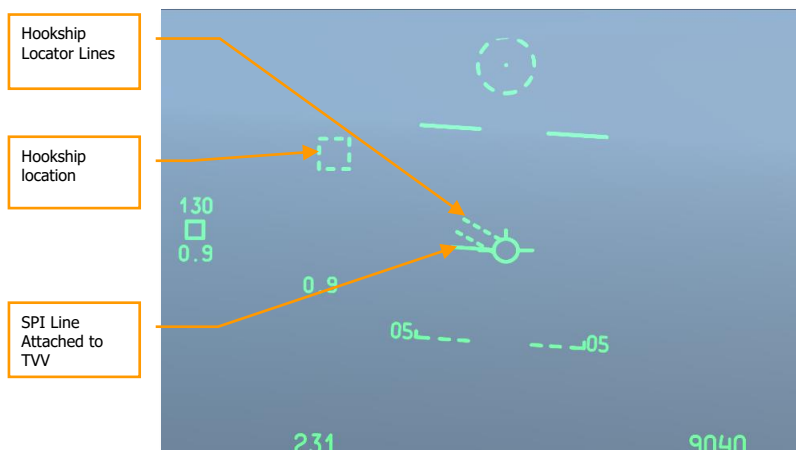

Figure 287. Hookship within HUD FOV and SPI outside HUD FOV

HUD Messages

In addition to the standard symbols and messages discussed in this chapter, you may receive other messages in special circumstances. These include:

GCAS Break X

A Break-X symbol is positioned in the center of the HUD and overwrites all other symbology. The Break-X flashes for 2 seconds and is provided under 2 conditions:

When the aircraft descends below 90' AGL with the landing gear handle UP

When the system determines that, under present flight parameters and radar altitude, an immediately initiated maximum performance roll to wings level and maximum performance pullout will just clear the ground

This symbology is accompanied by a "PULL UP PULL UP" VMU Warning.

CCIP INVALID

This will occur when shooting “uphill” in a CCIP GUNS mode and DTSAS target elevation exceeds aircraft elevation. “CCIP INVALID” is displayed and CCIP gun symbology is removed. Valid CCIP gun symbology is restored (and the “CCIP INVALID” removed in GUNS mode) when:

- The DTSAS target elevation goes below aircraft elevation
- A valid CCIP gun solution has been available for 1 second afterward
- Switched to either the 4000-ft or 4/8/12 gunsights

USE CCRP

“USE CCRP” is displayed when illumination flares are selected (LUU, M257, M278) in CCIP mode.

INVALID FUZING

The “INVALID FUZING” message is displayed on the HUD when an invalid combination of fuze and bomb data for the munition is selected for CCIP and CCRP modes.

When utilizing the radar function of the FZU-39 (Tail Fuzing enabled), in order to warn of a potential CBU-87 or CBU-103 release below the FZU-39 HOF entered in the inventory settings for the weapon, “INVALID FUZING” will be displayed in the HUD when the aircraft descends below the set HOF. It will remain until the aircraft climbs above the set HOF.

For MK-82LD, MK-84LD, GBU-10, and GBU-12 when the FMU-139LD is selected as the tail fuze, selecting TAIL fuzing only will cause “INVALID FUZING” to be displayed until corrected in the weapons profile.

For MK-82AIR, selecting NOSE fuzing with Configuration set to Fixed High.

For MK-82AIR, selecting TAIL fuzing with an FMU-139 fuze and any configuration other than Fixed High.

For any LUU – any fuze setting other than SAFE will display “INVALID FUZING.”

Altitude Alert Numerics

There are 3 altitude alerts available:

- **AGL Floor.** Displayed as unsigned 4-digit numeric. Value range 0–5000 feet. Defaults to 500 feet AGL. Example “500 AGL FLOOR”

- **MSL Floor.** Displayed as unsigned 5-digit numeric. Value range 0–45000 feet. Defaults to 0 feet MSL. Example: "10000 MSL FLOOR"
- **MSL Ceiling.** Displayed as unsigned 5-digit numeric. Value range 0–45000 feet. Defaults to 0 feet MSL. Example: "12000 MSL CEILING"

The altitude alert numeric is displayed without changing for 1/2 second when the ALT ALERT key on the UFC is activated and remains displayed for 4 seconds after the switch is released. While the altitude alert numeric is displayed, additional presses of the ALT ALERT key on the UFC rotate through AGL FLOOR (default), MSL FLOOR and MSL CEILING.

While the altitude alert numeric is displayed, the DATA rocker can be used to change the alert value by pressing for greater than ½ second:

- **AGL FLOOR:** DATA rocker adjusts altitude in increments of 10 feet from 0 to 500 feet, and in increments of 100 feet from 500 to 5000 feet.
- **MSL FLOOR/CEILING:** DATA rocker adjusts altitude in increments of 10 feet from 0 to 500 feet, and in increments of 100 feet from 500 to 45000 feet.

Additionally, while the corresponding altitude alert numeric is displayed, specific altitudes in 1-foot increments can be entered into the scratchpad (UFC or CDU); pressing the ENT button on the UFC will enter that value into the alert as long as it is in the range specified above.

Whenever the aircraft descends below the AGL or MSL floor altitude, the "ALTITUDE" VMU Warning will be annunciated.

Whenever the aircraft ascends through the MSL ceiling altitude, the "CEILING" VMU Warning will be annunciated.

Delta Radar/EGI GPS Altitude Numerics

The Delta Altitude Numerics are displayed when the UFC ENT key is depressed and remain displayed for 10 seconds unless terminated by one of the following:

- Actuation of any other switch on the UFC
- Selection of a different HUD display mode or option
- A second depression of the UFC ENT key

When the ENT button is pressed on the UFC, 2 values will appear in the HUD:

- The first value is the difference between the true MSL altitude and the CADC pressure altitude. It is displayed as a signed 4-digit numeric followed by a "D." Valid range is -9999 to 9999 in 1-foot increments.
- The second value is the true MSL altitude computed by either adding radar altimeter altitude to steerpoint elevation or using GPS altitude. It is displayed below the delta value as a signed 5-digit numeric followed by an "R" or "G." Valid range is -1000 to 32767 in 1-foot increments.

This feature is used to store local correction factor for barometric altitude in the IFFCC for optional use during subsequent weapon deliveries in delta mode.

Depressing the ENT button displays the Radar and EGI GPS Delta calibration values but does not store them. The values are displayed in the center of the HUD for 10 seconds, with the EGI GPS based calibration values displayed first.

Activation of the UFC SEL switch will toggle the display between the EGI GPS and radar-based calibration levels. "XXXX R" will be displayed for the radar value if the ENT button is pressed above 5000 feet AGL.

If ENT is depressed again within 10 seconds, the values currently displayed will be automatically stored in the DELTA CAL IFFCC Submenu.

If ENT is not depressed again within 10 seconds, no new data will be stored, and the previously stored Delta values will be used.

Markpoint Elevation

Markpoint elevation is displayed as a 5-digit numeric (appended with the letter "M" if displayed in meters). It is displayed whenever an overhead mark is taken, either by pressing the MK button on the UFC or by pressing the MK button on the CDU. This display will flash for 10 seconds or until it is accepted by pressing the ENT button on the UFC.

Markpoint elevation is determined by using the DTSAS elevation for the coordinates of the point over which the mark was taken.

The position of the point over-flown is stored in the markpoint portion of the waypoint database in location A, B, C, etc. MARK A (B, C, etc.) will be annunciated on the CDU for 10 seconds or until the FA pushbutton is depressed. On the HUD, the steerpoint identifier, number, and distance fields will flash for approximately 5 seconds, and the markpoint elevation is displayed and flashes for approximately 10 seconds.

Weapons Event Marker

The weapons event marker symbol is the letter "W" and appears on the HUD when the Master Armament switch is out of SAFE, and either the trigger is depressed to second detent or **weapon release button** is depressed, and release criteria is met.

The weapon event marker is displayed when the first weapon release occurs, and stays displayed until the weapons release button is released.

Helmet Mounted Cueing System

The Helmet Mounted Cueing System (HMCS) is a helmet-mounted display and sensor package that augments the pilot's view. The display gives the pilot additional situational awareness wherever their head is pointed, and the sensor package tracks the pilot's head position using this information to cue sensors and make designations. The HMD has an 18° field of view (FOV).

HMD Symbology

Basic HMD Symbology

When the HMD is active, the pilot's view is augmented with the following symbology:

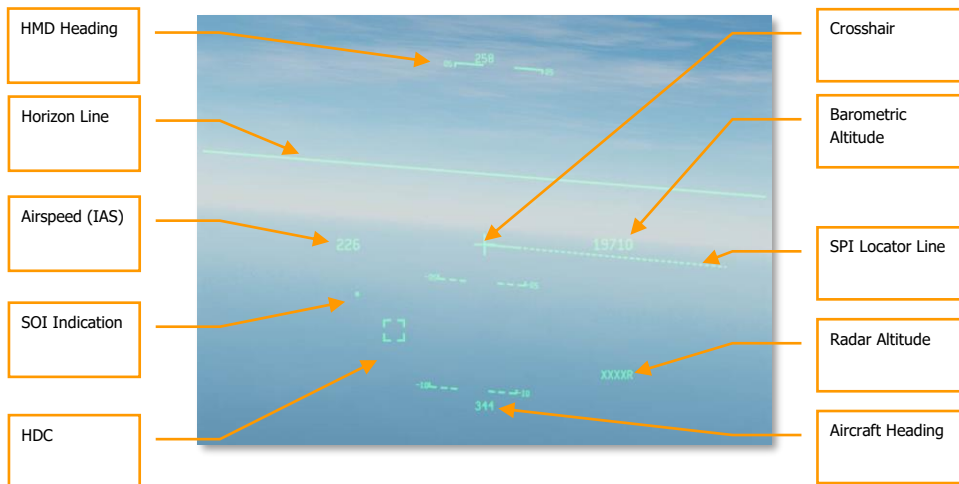

Figure 288. HMCS Basic Symbology

Crosshair. Indicates the pilot line-of-sight (LOS).

Helmet Designation Cue (HDC). The HDC is used to designate points on the ground. The HDC initializes caged to the crosshair. The pilot can then slew the HDC using the target designator cursor (TDC) when the HMCS is SOI. When the pilot stops slewing, the HMCS will attempt to ground-stabilize the HDC. If the HMCS cannot ground-stabilize the HDC (e.g., it is pointing in the sky), the HDC will remain helmet-stabilized until it is slewed over the ground. Once the HDC is ground-stabilized, the pilot can hook it by looking at it to place the crosshair within it, and pressing TMS Forward Short.

SPI Locator Line. When the SPI is outside the helmet FOV, a target locator line (TLL) is drawn from the crosshair in the direction of the SPI. The TLL line consists of solid and dashed segments. The solid segment grows as the pilot looks further away from the SPI.

Horizon Line. Indicates the horizon. When the horizon is outside the HMD FOV, it is drawn as a dashed line and clamped to either the top or the bottom of the display. This is referred to as the "ghost horizon line."

HMD Heading. The magnetic heading of the pilot LOS.

Aircraft Heading. The magnetic heading of the aircraft.

Airspeed. Current aircraft indicated airspeed.

Barometric Altitude. Current aircraft altitude.

Radar Altitude. Altitude above surface.

SOI Indication. Shows when the HMD is SOI.

Navigation HMD Symbology

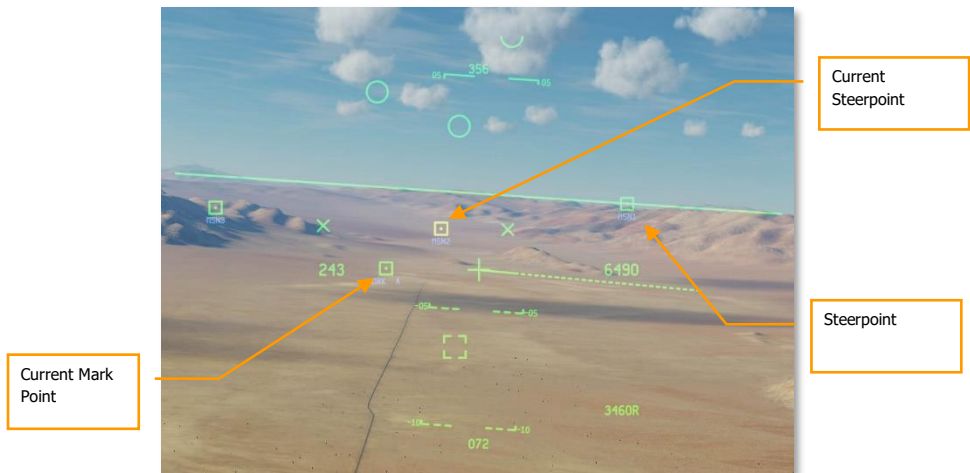

Figure 289. HMCS Navigation Symbology

Steerpoint. Steerpoints are shown in green. The name of the steerpoint is printed below the indicator.

Current Steerpoint. The current steerpoint is shown in yellow.

Current Mark Point. Mark points are shown similarly to steerpoints.

Unit HMD Symbology

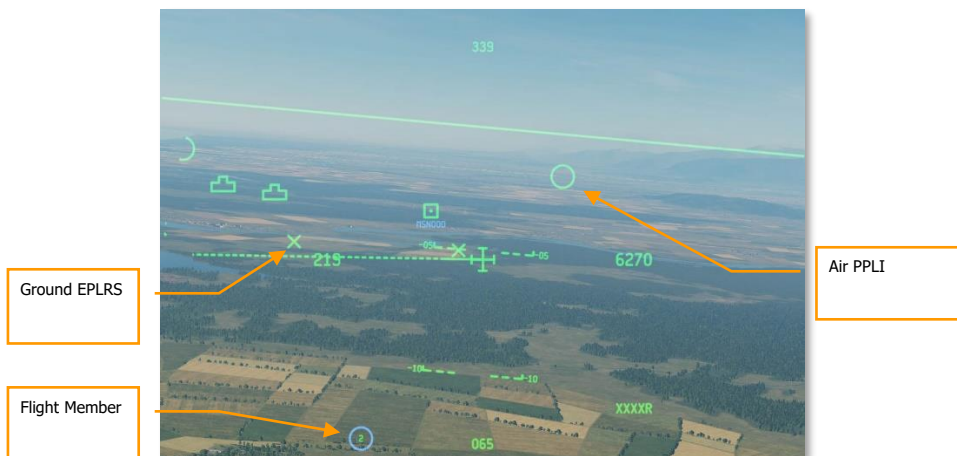

Figure 290. HMCS Unit Symbology

Flight Member PPLI. Other flight members are displayed as blue circles with their flight position in green in the center. Note that the PPLI symbol will lag with the actual aircraft due to datalink transmission delay.

Air PPLI. Other friendly aircraft are indicated as green circles.

Ground EPLRS. Friendly ground units with EPLRS radios.

HMCS Designation Symbology



Figure 291. HMCS Designation Symbology

Own SPI. Ownship SPI is indicated in white.

Donor SPI. The SPI from friendly, donor aircraft are indicated in green.

HMCS MFCD Page

The configuration page from the MFCD can be accessed from the STAT format. From the STAT format, press OSB3, labeled HMCS, to display the HMCS configuration page.



Figure 292. HMCS Configuration Page

Current Profile Selection. Press one of these OSBs to activate or edit profile 1, 2, or 3. When the profile is changed, the active profile name (e.g., "PRO1") will show on the HMCD for a few seconds.

Previous Page. Returns to the previous STAT page.

Next Page. Moves to the second HMCS configuration page (not implemented).

Selected Symbol. The HMD symbol selected for editing.

Select Symbol. Moves the selected symbol arrow up or down.

Quarter Page. Moves the selected symbol arrow up or down by a quarter-page.

Symbol Display. Toggles between three symbol display modes: OFF, ON, and OCLD (occluded).

Symbol Display Range. Enter a numeric value in the scratchpad and line-select it to OSB17 (RANGE) to change the maximum range at which this symbol will be displayed (in nautical miles). Symbols whose range is indicated by a dash cannot have their maximum range edited.

Day Mode. Selects the day brightness preset. The HMD brightness associated with that preset is shown below the word DAY.

Night Mode. Selects the night brightness preset. The HMD brightness associated with that preset is shown below the word NIGHT.

TGP Track Mode. Selects the track mode that the TGP will automatically attempt after cueing the TGP to the HMD. Options are POINT, AREA, and INR (inertial rates).

Configuring the HMCS

Changing Profiles

The pilot can select and configure among three different HMCS profiles, named PRO1, PRO2, and PRO3. These profiles are pre-configured by default to represent three different declutter levels, but can be configured by the pilot as they see fit.

When the HMCS is SOI, the pilot can cycle between the three profiles by pressing DMS right short.

To select a profile using the MFCD:

1. Display the STAT format on either MFCD.
2. Press the HMCS OSB (OSB3).
3. Press the OSB labeled either PRO1, PRO2, or PRO3 (OSB3 through OSB5) to activate that profile.

Editing Profiles

To edit a profile, first select a profile using the MFCD as described in the previous section. Once that profile is selected, its configuration will show on the MFCD where it can be edited.

1. Use the Symbol Select rockers (OSB19 and 20) to move the Selected Symbol Arrow adjacent an HMD symbol you wish to edit. If the symbol is not shown, you can use the Quarter Page rockers (OSB6 and 7) to jump the Symbol Select arrow quickly down the list.
2. Use the Symbol Display rotary (OSB18) to change the symbol display mode. OFF declutters the symbol. ON displays the symbol at all times. OCLD only shows the symbol when it's outside the

occlusion zone. (The occlusion zone prevents symbols from obscuring the pilot's view when the pilot is looking forward at the HUD or instrument panel.)

3. For symbols with editable ranges, enter a desired maximum range into the scratchpad, and press OSB17, labeled range, to change the maximum display range. When the symbol is beyond this range, it will not be displayed.
4. Repeat these steps for each additional symbol you wish to edit for this profile.

HMD Symbols

CROSSHAIR	Indicates HMD LOS
OWN SPI	Ownship SPI
SPI INDICATOR	TLL connecting crosshair to SPI when SPI is outside HMD FOV
HORIZON LINE	Horizon line or ghost horizon line
HDC	Helmet Designation Cursor
HOOKSHIP	Indicates hooked target
TGP DIAMOND	Indicates TGP LOS
TGP FOV	Dashed box outlining TGP FOV
FLIGHT MEMBERS	Flight member PPLI
FLIGHT MEMBER SPI	Donor SPI from flight member
DONOR AIR PPLI	Other aircraft PPLI
DONOR SPI	Donor SPI from other aircraft
AIR ENVIR	All other donor air assets
AIR VMF FRIEND	No function
AIR PPLI (NON-DONOR)	Air PPLIs except flight members and donors
AIR TRK FRIEND	No function
AIR NEUTRAL	No function
AIR SUSPECT	No function
AIR HOSTILE	No function
AIR OTHER	No function
GND ENVIR	All land and surface objects

GND VMF FRIEND	All ground VMFs
GND PPLI	No function
GND TRK FRIEND	No function
GND NEUTRAL	No function
GND SUSPECT	No function
GND HOSTILE	No function
GND OTHER	No function
EMER PONIT	No function
STEERPOINT	Current steerpoint
MSN/MARKPOINTS	Mission points and mark points based on steerpoint switch setting
MSN/MARK LABELS	Mission points and mark points text labels
AIRSPEED	Indicated airspeed
RADAR ALTITUDE	Radar altitude indication
BARO ALTITUDE	Barometric altitude indication
A/C HEADING	Aircraft heading
HELMET HEADING	Pilot LOS heading
HMD ELEV LINES	Pitch ladder

Changing the Brightness

The HMCS stores two brightness presets, DAY and NIGHT. Pressing OSB9 puts the HMD into DAY mode and allows the day brightness to be edited. Pressing OSB10 puts the HMD into NIGHT mode and allows the night brightness to be edited.

With the HMCS as SOI, pressing DMS forward and aft short changes the brightness for the current mode. The new brightness setting will be temporarily shown on the HMD, and the brightness value is updated on the MFCD as well.

Using the HMCS

Making the HMD SOI

To make the HMD SOI, press Coolie Switch down short. When the HMD is SOI, an asterisk will appear within the HMD FOV.

Designating Locations and Creating Markpoints

When the HMD is SOI, the Slew cursor can be used to move the Helmet Designation Cursor (HDC). If the HDC is slewed over a point on the ground, it will become ground stabilized. You can hook the HDC by looking at it to place the crosshair within the HDC rectangle and then pressing TMS forward short. The HDC will gain a second border indicating it is the hookship. You can also make the HDC SPI by pressing TMS forward long when either a) the HDC is hooked, or b) the crosshair is within the HDC rectangle.

To create a markpoint at the HDC location, press TMS right short while the HMD is SOI.

Slewing the TGP or Maverick to HMD LOS

To slew the Maverick seeker head to the HMD line of sight, first use the Coolie Switch to move SOI to the MAV page. Then, press DMS right long. Maverick LOS will slew to the HMD LOS. Note that the Maverick is not *slaved* to the HMD LOS; you must perform these steps again to slew the Maverick seeker head to the HMD LOS a second time.

To slew the TGP to HMD line of sight, first ensure SOI is *not* on the MAV page. Then, press DMS right long. TGP LOS will slew to the HMD LOS, and you will see a small diamond appear next to the HMD crosshair, indicating the new TGP LOS. Note that the TGP is not *slaved* to the HMD LOS; you must perform these steps again to slew TGP LOS to HMD LOS a second time.

Displaying TGP Video on the HMD

You can display TGP video on the HMD, so that TGP video is visible to the pilot when looking any direction. To do so, first set the right MFC to the TGP format, then make the HMD SOI, and finally press DMS left short to toggle TGP video on the HMD.

If you change the right MFC format, TGP video will no longer be displayed on the HMD, but it will again once you return the right MFC to the TGP format.

HMCS HOTAS Controls

The HOTAS controls for selection and operation of HMCS as SOI are shown below.

Display Management Switch (DMS)

Forward Short Increase HMD Brightness

Forward Long	Increase HMD Brightness
Aft Short	Decrease HMD Brightness
Aft Long	Decrease HMD Brightness
Left Short	Display Right MFCD TGP Video
Left Long	HMD On/Off
Right Short	Cycle HMCS Profiles
Right Long	Slave TGP to HMCS Line of Sight

Target Management Switch (TMS)

Forward Short	Hook Symbol Under Crosshair
Forward Long	Make Hooked Object or HDC SPI
Aft Short	Unhook Symbol
Aft Long	Reset SPI to Steerpoint
Left Short	Acknowledge WCN
Left Long	Broadcast SPI
Right Short	Create Mark Point at HDC
Right Long	Make Last Mark Point SPI

Understanding SOI and SPI

Sensor of Interest (SOI)

Given that the A-10C has three separate displays that can be controlled (two MFCD and the HUD), you must have a way to determine which control display you are commanding. This is done by determining the Sensor of Interest (SOI). Only one control display can be the SOI at a given time and at least one control will always be assigned as the SOI. To visually indicate which display is assigned as the SOI, visual cues are provided:

MFCD SOI Indications

If the SOI sensor is being displayed on an MFCD (TAD, TGP, and MAV), then a “container” box is drawn around the interior MFCD display.

For the other MFCD that may be set to a sensor, a “NOT SOI” message is displayed. The below examples apply to TAD, TGP and Maverick.



Figure 293. MFCD Page as SOI



Figure 294. MFC Page as NOT SOI

HUD SOI Indication

If the HUD is the SOI, then an asterisk is displayed in the lower left portion of the HUD. When the asterisk is missing, the HUD is not the SOI.

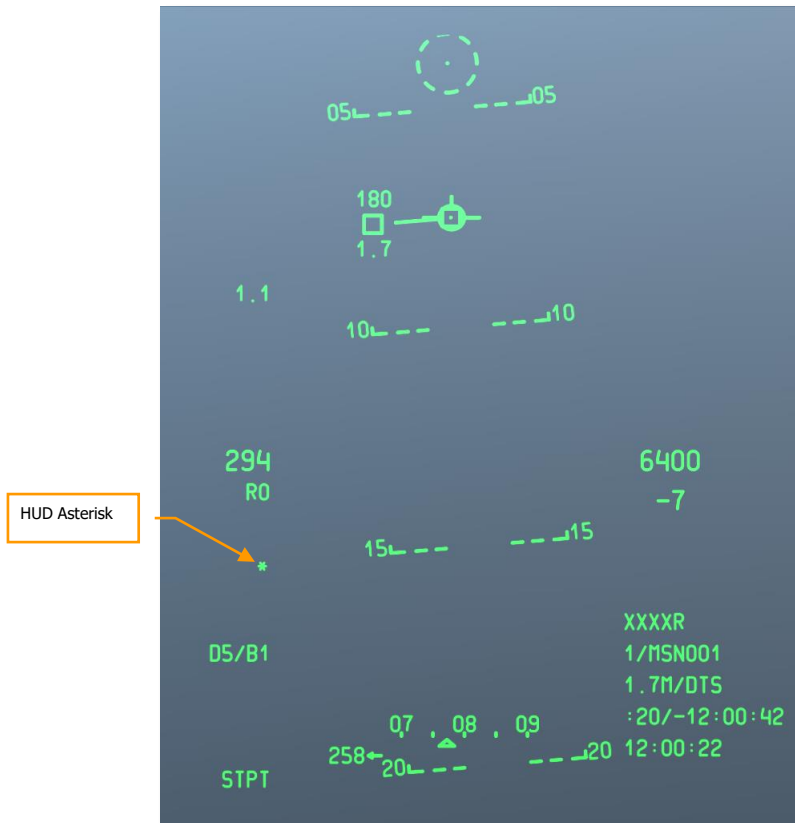

Figure 295. HUD as SOI Indication

HMCS SOI Indication

If the HMCS is the SOI, then an asterisk is displayed in the lower left portion of the HMCS. When the asterisk is missing, the HMCS is not the SOI.

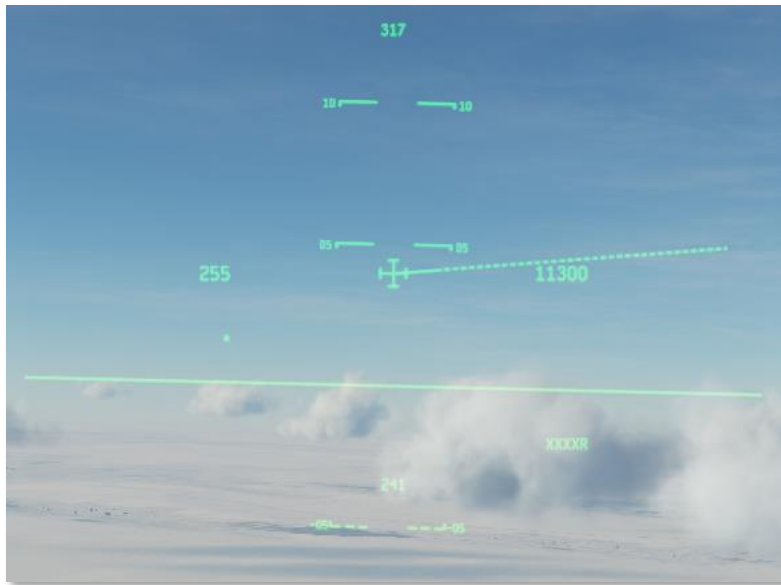

Figure 296. HMCS as SOI Indication

Setting SOI

To set SOI, you can either select the desired SOI page from OSB 9 – 15, or use the Coolie Hat functions on the HOTAS:

- Up Short. Set HUD as SOI
- Down Short. Set HMCS as SOI
- Left Long. Set Left MFCD as SOI
- Right Long. Set Right MFCD as SOI

Sensor Point of Interest (SPI)

A SPI is a 3D point in space that the systems use as a shared reference location to cue weapons, aim sensors and send over the datalink. This is a key component of the A-10C and helps you to locate targets with onboard sensors (Targeting Pod, Tactical Awareness Page, HUD, HMCS, Maverick and AIM-9), then cue weapons and slave sensors to it.

The default SPI is the steerpoint. Once a sensor has been set as the Sensor of Interest (SOI), the sensor may designate the SPI. Once a SPI has been defined, the SOI can change without changing the SPI. The current SPI generator is always indicated in the lower left corner of the HUD.

The system is always tracking a SPI with the current steerpoint being the default SPI (such as when the aircraft is powered). The exception is if the SPI is commanded to steerpoint but there is no valid steerpoint because the CDU is not available.

SPI can be set by either **TMS Forward Long** or holding **LCtrl + Up Arrow**.

SPI Command Functions

Set Sensor as SPI – This function allows the TGP, TAD, Maverick, HUD, or HMCS to define the SPI. **TMS Forward Long**.

Select HUD SPI sub-mode – If the HUD is selected as the SOI (default) and this function is selected, the GUN and CCIP pipers act as the SPI (depending on the HUD Mode – if NAV or AIR-to-AIR mode this makes the steerpoint the SPI as well). **TMS Aft Short**.

Slave All to SPI – Upon command, all active sensors will track the current SPI. If a slaved sensor can no longer track the SPI, it will either track the last known position or return to boresight. This can happen if the SPI source is changed, or a SPI tagged TAD symbol is changed. However, a sensor can be set individually to track a different target/object, but the remaining sensors will maintain track on the SPI. **China Hat Forward Long**.

SPI Sensor Designators

Maverick. When the Maverick is SOI and the “set sensor as SPI” function is selected, the line of sight point to the ground marks the SPI using **TMS Forward Long**. As the Maverick seeker slews, the SPI slews along with it. To un-assign the SPI from the TGP, you may either use the “reset SPI to steerpoint” function or assign the SPI to another sensor.

Targeting Pod (TGP). Like the Maverick, when the TGP is SOI and the “set sensor as SPI” function is selected, the line of sight point at ground intersection marks the SPI with a **TMS Forward Long**. This will be the same coordinates and elevation displayed in the TGP display. As the TGP crosshairs are slewed, the SPI will move along with it. To un-assign the SPI from the TGP, you may either use the “reset SPI to steerpoint” function or assign the SPI to another sensor. **TMS Aft Long**.

Note: In the two examples above, the SPI symbol on the TAD would move according to the movement of the Maverick seeker, TGP, or HUD symbol if they are assigned as the SPI sensor.

Tactical Awareness Display (TAD). To designate the SPI from the TAD page, you must first hook a symbol (**TMS Forward Short**). Once a symbol (TGP diamond, waypoint, bullseye, etc.) is hooked, and the "set sensor as SPI" function is activated, the SPI will overlay the tagged symbol with a **TMS Forward Long**. To un-assign the SPI to the hooked symbol, the user may either use the "reset SPI to steerpoint" function or assign the SPI to another sensor.

Head-Up Display (HUD). When the HUD is assigned as the SOI, the SPI can be assigned in two primary ways.

TDC mode. Using the "set sensor as SPI" function, the TDC line of sight intersection with the ground marks the SPI point. As the TDC slews around the HUD, the SPI will slew with it.

HUD mode. When in this mode, the SPI will vary according to the HUD type selected. These types include:

NAV. When in Navigation mode, the SPI is automatically assigned to the steerpoint.

GUNS. When in Guns mode, the line of sight from the gun piper to the ground marks the SPI. As the gun piper and aircraft move, the SPI will move accordingly. If there is no valid line of sight to ground, the SPI will revert to the steerpoint until there is a valid line of sight to ground again.

CCIP. When in CCIP mode, the line of sight from the center reticle piper to the ground marks the SPI. As the piper and aircraft move, the SPI will move accordingly. If there is no valid line of sight to ground, the SPI will revert to the steerpoint until there is a valid line of sight to ground again.

CCRP. When in CCRP mode, the SPI is automatically assigned to the steerpoint.

When in **Air-to-Air mode**, the SPI is automatically assigned to the steerpoint.

Helmet-Mounted Cueing System (HMCS). When the HMCS is assigned as the SOI, the line-of-sight point to the ground marks the SPI using **TMS Forward Long**. SPI will not follow the HMCS as LOS changes. Pressing **TMS Forward Long** again updates the SPI to the HMCS LOS.

The table below summarizes each of the possible SOI sensors that can determine the SPI and the method used to designate the SPI.

SOI	DEFINABLE SPI
TGP	TGP LOS
TAD	TAD HOOKED SYMBOL
MAVERICK	MAVERICK LOS

SOI	DEFINABLE SPI
HUD	
NAV	STPT (DEFAULT)/TDC
GUNS	GUN SOLUTION (DEFAULT)/TDC/STPT
CCIP	CCIP SOLUTION (DEFAULT)/TDC/STPT
D-CCIP	CCIP RETICLE (DEFAULT)
CCRP	STPT (DEFAULT)/TDC
A-A	STPT (DEFAULT)
HMCS	HMCS LOS

Countermeasure Systems

The A-10C has a defensive system that helps alert and protect you against enemy weapon systems with radar and laser illumination. This includes support for Electronic Counter Measure (ECM) pods, chaff and flare dispensers, a radar warning receiver set, and a Missile Warning System (MWS). These systems are combined to form the **Countermeasures Set (CMS)**. The CMS has two primary panels: The Countermeasures Signal Processor (CMSP) panel and the Countermeasures Set Control (CMSC) panel.

Countermeasure Signal Processor (CMSP) Panel

The CMSP panel is located on the forward right console and is your primary means of selecting and programming the CMS system. The CMSP has the following functions:



Figure 297. CMSP Panel Test Mode

1. **The Mode Select Dial.** This is a rotary dial with 5 positions located on the right side of the panel. Positions include:

- 1.1. **OFF:** System power is set to off. When in this mode, the CMSP and CMSC displays are blank and none of the CMS systems are operational in any way.
- 1.2. **STBY:** When the mode switch is set to standby, power is applied to the CMSP and CMSC and they are fully functional and can be adjusted, but dispensing chaff and flares is not possible and the ECM and MWS will not take any active measures.
- 1.3. **MAN:** When set to Manual mode:
 - i. You may manually run the selected chaff/flare program with the Countermeasure Switch on the HOTAS.
 - ii. You may manually select the ECM program and turn ECM on and off.
 - iii. You will receive MWS indications, but you must manually select the best program and release countermeasures.
- 1.4. **SEMI:** When in Semi-Automatic mode:
 - i. The system will automatically select the best chaff/flare program according to the detected radar. However, it is up to you to start and stop the countermeasure release program.
 - ii. The CMS will automatically select the best ECM program to counter the detected radar threat. However, you must consent the system to go active.
 - iii. You will receive MWS indications, and the CMS will select the best chaff/flare program, but you must manually release countermeasures.
- 1.5. **AUTO:** When in Automatic mode:
 - i. The system will automatically select the best chaff/flare program and initiate and stop the program.
 - ii. The CMS will select the best ECM program based on the radar detected.
 - iii. The MWS will detect threats, select the best program and automatically release countermeasures.
 - iv. When the dial is set to any of these four positions (other than OFF), the result is the same in that the alphanumeric display will show the status of the four systems. Along the bottom of the display, from left to right, are listed:
2. **System Select Switches.** There are four System Select switches, and each switch has 3 positions (up, middle, and down). When a switch is in the down OFF position, power is removed from that system. If the switch is set to the middle ON position, power is applied to the selected system. If the switch is toggled to the up MENU position, you enter the programming mode (DISP only).

- 2.1. **DISP Switch.** This DISP switch allows you to enable and program the chaff and flare dispensers. This is an important function to help you defeat both radar and infrared guided missiles.



Figure 298. CMSP Dispenser ON

- i. **ON Position:** When the DISP switch is in the ON position (after a 5 second RDY indication), the alphanumeric display will change to allow you to view remaining chaff and flare stores. When ON, CHAF, FLAR, OTR1 and PROG are displayed left to right across the bottom on the display window. Above each of these on the top line is a numeric that indicates how many of the expendables remain on the aircraft or the selected dispenser program. The numeric will flash when it is being dispensed.

Pressing the NXT rocker will cycle between programs (also indicated on the CMSC). If the last program is selected and the NXT rocker is pressed up, a new program will be created (A-Z in sequence) that is a duplicate of the preceding one. You can use this process to create new programs.

The next program can also be selected by pressing the CMS switch right or the previous program by pressing the CMS switch left.

- ii. **MENU Position:** When placed momentarily in the Up Menu position, you may program how the CMS releases chaff and flares for the selected program (A-Z). Along the bottom of the display are fields for CHAF, FLAR, INTV and CYCL.



Figure 299. CMSP Dispenser MENU

CHAF. The Chaff field allows you to determine the number of chaff bundles that will be released in the current program. To set, you will press the SET button underneath the CHAF label and the numeric will flash indicating it can be adjusted. You may then use the NXT button to increase or decrease the amount.

FLAR. The Flare field allows you to determine the number of flares that will be released in the current program. To set, you will press the SET button underneath the FLAR label and the numeric will flash indicating it can be adjusted. You may then use the NXT button to increase or decrease the amount.

INTV. The Interval field allows you to set the time between countermeasure releases in the current program. This can be set the same way as chaff and flares but in increments of .25 seconds from .25 to 5.

CYCL. The Cycle field allows you to set the number of times the program will repeat itself. This is set in the same way as the other fields. Valid range is from 1 to 99.

Pressing the RTN button saves the program, and a second press returns the screen to the dispenser status screen.

- 2.2. **RWR Switch.** The radar warning receiver switch controls power to the RWR equipment. Placing the switch in Menu puts the RWR into TEST mode.
- 2.3. **JMR Switch.** The Jammer switch controls power to the ECM jammer loaded on the aircraft. Placing the switch in Menu has no function.

- 2.4. **MWS Switch.** The Missile Warning System (MWS) switch controls power to the MWS detectors. Placing the switch in Menu has no function.
3. **Alphanumeric Display Window.** The display window is a rectangular screen at the top of the CMSP. The top line consists of 16 characters and provides information on payload and system status. The second line consists of four-character displays in four data segments. It is here that you can view chaff and flare inventory and program release patterns.
4. **SET Option Select Buttons (OSB).** Four OSB buttons are located directly below the display window, positioned horizontally; each has an upward pointed arrow on it. Use these buttons to select items on the Alphanumeric Display window.
5. **NXT (Next) Switch.** Located right of the display window, the Next switch is a 2-position rocker switch. Pressing the rocker up or down cycles values of the selected field. Use the Set keys to select the field. It can also cycle programs.
6. **RTN (Return) Switch.** Located to the right of the Next switch, the Return button will save a program.
7. **JTSN (Jettison) Switch.** Located below the Next button, the Jettison switch is a two-position switch: Up and Down. In the JTSN position, chaff and flares will be jettisoned from the aircraft. The down position labeled OFF, is the normal state.
8. **BRT (Brightness) Knob.** The brightness knob, labeled BRT, can be rotated to increase or decrease the light intensity of the labels on the panel.

Activate a Program

Each program (PROG) is assigned a letter (A - Z) and they can be cycled by either pressing the CMS switch Left or Right, or by pressing the NXT button on the CMSP. The selected program is also displayed on the CMSC below the HUD.

When in MAN or SEMI modes, press CMS Forward to start the program. Press CMS Aft to cease the program.

If in AUTO mode, you do not have direct control of the program selection or activation.

PROG	CHAFF QTY	FLARE QTY	INTERVAL (SEC)	CYCLE
A	2	0	1	10
B	4	0	0.5	10
C	0	4	1	10
D	2	2	1	10
E	2	2	0.5	10
F	4	4	1	10
G	4	4	0.5	10
H	1	0	1	1
I	2	0	1	1
J	0	1	1	1
K	0	2	1	1
L	1	0	1	20
M	0	1	1	20

Table 1. Default Programs

Edit a Program

1. Using the NXT switch, select the program that you wish to edit.
2. Right click on the DISP switch to toggle it to MENU.
3. Press the SET button under the value you wish to edit (CHAF, FLAR, INTV, or CYCL). The current value will then flash.
4. Use the NXT switch to edit the value.
5. Press the RTN button to save your changes.

- Press the RTN button again to exit MENU.

Countermeasures Set Control (CMSC)



Figure 300. CMSC Panel

The CMSC panel is located centrally on the front dash above the ADI. This panel allows you to control some aspects of the azimuth indicator display, view chaff and flare status, and change electronic counter measure and MWS functions. Functions of the CMSC panel include:

- BRT (Brightness) Knob.** The brightness knob, labeled BRT, can be rotated to increase or decrease the light intensity of the labels on the panel.
- AUD (Audio) Knob.** The audio knob, labeled AUD, can be rotated to increase or decrease the RWR audio warning volume. Each detected radar signal has a unique audio tone based on its Pulse Repetition Frequency (PRF) signal.
- JMR (Jammer) Window.** In this display window, up to eight characters can be displayed and indicate the selected jammer program and activity status. The left side of the jammer window indicates the status of the jammer. This can either be OFF, SBY (standby) or OPR (operating) depending on the position of the mode selector dial and if the aircraft is being locked by a radar. On the right side of the window the selected jammer program is displayed. These are pre-loaded and include:
 - AIR.** Program to counter most air-to-air radars.
 - SAM1.** Program to counter older-generation SAM systems like SA-3, SA-6 and SA-8.
 - SAM2.** Program to counter newer-generation SAM systems like 2S6, SA-16, SA-11, SA-10, and SA-15.

3.4. **AAA.** Program to counter radar-directed gun systems like ZSU-23-4 and ZU-23 / Dog Ear.

An example may be: "OPR SAM1". The button to the left of the window allows you to cycle through jammer programs when the Mode dial is set to Manual or Semi.

When the jammer is in SBY (standby) and the aircraft is being illuminated in target search/acquisition mode by an enemy radar, the jammer will stay in SBY mode. However, if your aircraft is locked in target tracking mode, it will select the appropriate jammer program (when in Semi and Auto modes) and automatically go to OPR (operation) mode to attempt to jam the enemy radar and break the lock if in AUTO. This is termed a Self-Protection Jammer (SPJ). The JMR field will also flash when in OPR mode. When no longer being locked, the jammer will return to SBY mode. This assumes SEMI and AUTO modes. When in MAN mode, you can use the button next to the JMR field to cycle between the jammer programs.

On the HOTAS, you have the CMS switch to also select jammer programs and toggle between SBY and OPR modes.

4. **CHAFF-FLARE Window.** This 8-character display window in the upper right portion of the panel indicates the number of remaining chaff and flares, dispenser activity, the CMS mode dial setting, and the active dispenser program. In the display field, under the CHAFF label, the number of remaining chaff bundles is listed and defaults to 240 bundles. Under the FLARE label, the number of remaining flares is listed and defaults to 120 flares. Between them is an underlined letter designating the CMS mode. Modes include:

4.1. **X** – Standby

4.2. **M** – Manual

4.3. **S** – SEMI

4.4. **A** – AUTO

With each release of a chaff bundle or flare though, a diamond in the center of the display is shown momentarily. If continuous dispense is selected, the diamond will be shown as long as chaff or flares are being released.

When the DISP selector switch is set to the OFF position, OFF is displayed instead of the chaff and flare counts.

If either the chaff or flare inventory reaches or falls below 50, the number is replaced with a LOW indication. If either chaff or flares are completely expended, N/L will be displayed for that counter.

Along the left portion of the display is a letter indicator that shows the current dispenser program (A-Z).

5. **MWS (Missile Warning System) Window.** When a missile launch has been detected by the MWS system, this window will indicate LAUNCH. When the MWS has power, it will display ACTIVE and with no power it will display OFF.
6. **SEP (Separate) Button.** To expand groupings of symbols on the RWR display such that they can be more easily read, you may press the SEP button on the CMSC. Upon doing so, the symbols will be separated radially outwards from each other.
7. **PRI (Priority) Button.** The Azimuth Indicator can display up to 16 symbols simultaneously; however, this can lead to a rather crowded display. By pressing the PRI button on the CMSC, you can toggle between OPEN mode that can display the 16 highest priority threats or PRI mode which will only show the five highest threats. When PRI is active, the green light above the button will be lit.
8. **UNK (Unknown) Button.** No function.
9. **ML (Missile Launch) Light.** This red light flashes when a missile has been launched near your aircraft. Missile launches can be detected by either the RWR or MWS. There will be an accompanying missile launch warning tone.

ALR-69(V) Radar Warning Receiver (RWR)



Figure 301. ALR-69(V) RWR

The RWR is a circular-shaped display on the left of the front dash that provides you a visual representation of radar emitters, detected missile launches, and laser illumination around your aircraft. The display is in planview with your aircraft in the center. As threats are displayed around the center of the display, the icons represent the azimuth direction to the threat. For example: an icon of the left side of the display would indicate an emitter located off your left. In addition to the icons, an audio system will alert you to the status of the radars detected (search, track, and launch). The locations of radar emitters and detected missile launches on the display do not necessarily correlate to emitter range from your aircraft.

The distance of the threat icon from the center of the display indicates radar signal strength. The closer the icon is to the center of the display generally indicates the closer the radar is to you.

In the center of the display is a center dot and four noise bars that form a cross. These indicate normal operations. Additionally, a vertical cycle timer line flashes alternatively up and down at the

end of the right noise bar. If the display is not indicating reliable data, the center dot is replaced with an "F" symbol.

Threat Symbols. Each detected radar or missile launch will be displayed as a symbol according to the type of detection. Possible symbols in this simulation include:

- Ground Radars
 - **A** – "Gepard" and ZSU-23-4 Self Propelled Anti-Aircraft guns
 - **M** – Missile detected by Missile Warning System (MWS)
 - **L** – Laser illumination
 - **S6** – 2S6 "Tunguska"
 - **3** – SA-3
 - **6** – SA-6
 - **8** – SA-8
 - **10** – SA-10 "Flap Lid" tracking radar
 - **CS** – SA-10 "Clam Shell" low altitude search radar
 - **BB** – SA-10 "Big Bird" search radar
 - **11** – SA-11/17 tracking radar
 - **SD** – SA-11/17 "Snow Drift" search radar
 - **13** – SA-13
 - **DE** – "Dog Ear" search radar
 - **15** – SA-15
 - **RO** – Roland
 - **PA** – Patriot
 - **HA** – I-HAWK
 - **S** – Early Warning or Ground Control Intercept Radar
- Airborne Radars
 - **E3** – E-3A AWACS
 - **E2** – E-2C AWACS
 - **50** – A-50U AWACS
 - **23** – MiG-23ML
 - **25** – MiG-25PD
 - **29** – MiG-29, Su-27, and Su-33
 - **31** – MiG-31
 - **30** – Su-30
 - **34** – Su-34
 - **M2** – Mirage 200-5
 - **F4** – F-4
 - **F5** – F-5
 - **14** – F-14

- **15** – F-15
- **16** – F-16
- **18** – F/A-18

A symbol can have three states on the display:

- If a symbol is displayed with no circle around it, it indicates that the radar is in acquisition/search mode. When a new emitter is detected, a new threat tone will be heard.
- If a symbol has a steady circle around it, it indicates that the radar is tracking/locked on to your aircraft. When being tracked by an engagement radar, you will be provided a radar lock tone.
- If a symbol has a flashing circle around it, it indicates that the radar is supporting a missile that has been launched at you. When being launched on by a radar-guided missile, you will hear a missile launch tone. When a missile launch has occurred, the Missile Launch (ML) light on the CMSC will turn on. A detected missile will be displayed as an M symbol with a flashing circle around it.

When the Missile Warning System (MWS) is active and a missile launch has been detected by the sensors on the wings and tail, an "M" is displayed along the azimuth the launch was detected. The symbol will continue to appear 10 seconds after the launch is no longer detected (missile motor has stopped burning). Note that the MWS cannot distinguish between enemy and friendly missiles or air launched missiles from ground launched missiles. As such, you may receive launch indications from both friendly and ground units.

When a laser illumination on the aircraft is detected, an "L" is displayed along the azimuth the laser was detected. The symbol will continue to appear as long as the laser illumination is detected.

AIRCRAFT STARTUP PROCEDURES



AIRCRAFT STARTUP PROCEDURES

When starting a mission from the parking ramp with all systems shut down (cold aircraft), you will need to learn how to bring the aircraft to life using the startup procedures. Just like in the real aircraft, we suggest a “flow” that allows you to set up your instruments and power-up other systems. The flow described below is the one we suggest, but just like real A-10 pilots, you may create your own that works for you. After you do this a few times, it will start to feel like second nature.

In addition to manually starting up the aircraft, you can also use the automatic start.

Flight Preparation

When you first enter the aircraft, you will want to go through the following list of items to make sure all your switches, dials and indicators are set up correctly before starting things up. Go around the cockpit clockwise left to right and confirm that all switches are in their normal (or off) positions.

Left Console

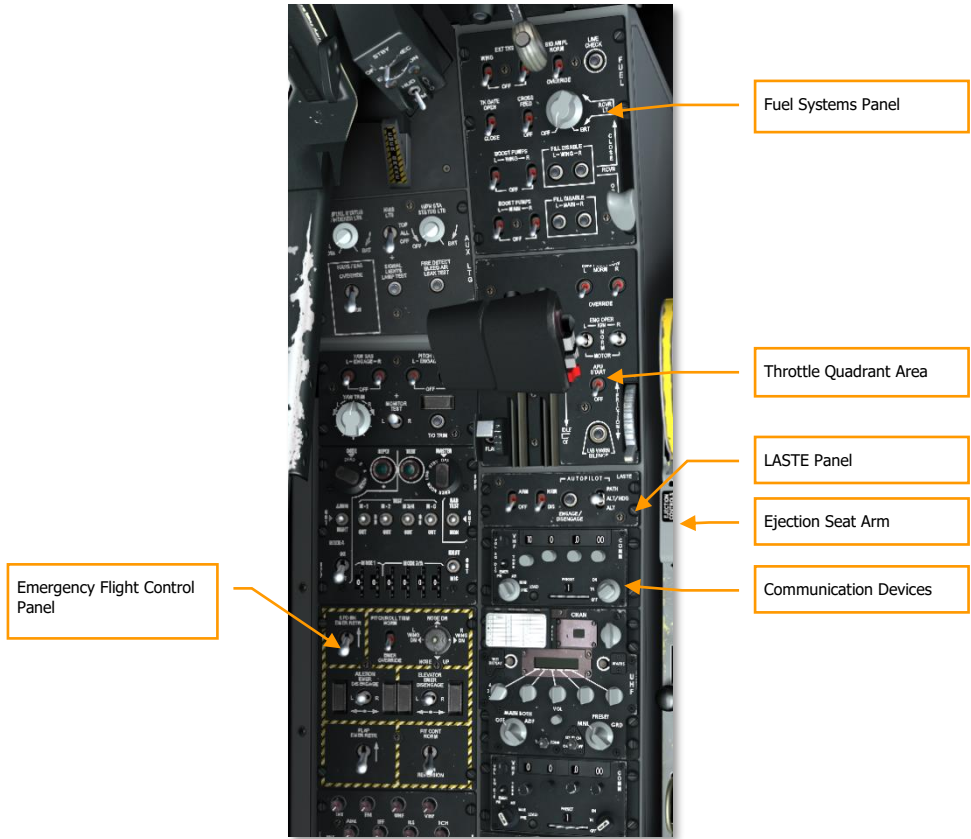

Figure 302. Left Console

LASTE Panel:

1. Set EAC switch of OFF.
2. Set RADAR switch to DIS.

Communication Devices:

3. Set VHF radio 2 channel presets on VHF 2 Radio Panel (VHF FM). You may wish to do so according to the frequency specified in the mission briefing.

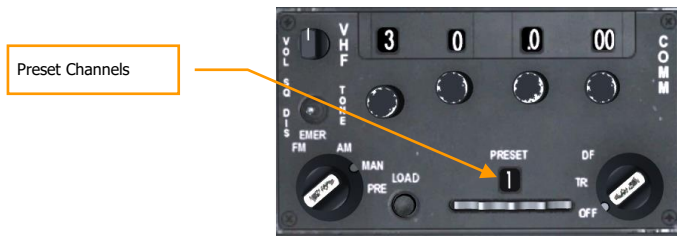
**Figure 303. VHF Radio 2 Head**

4. Arm the ejection seat.

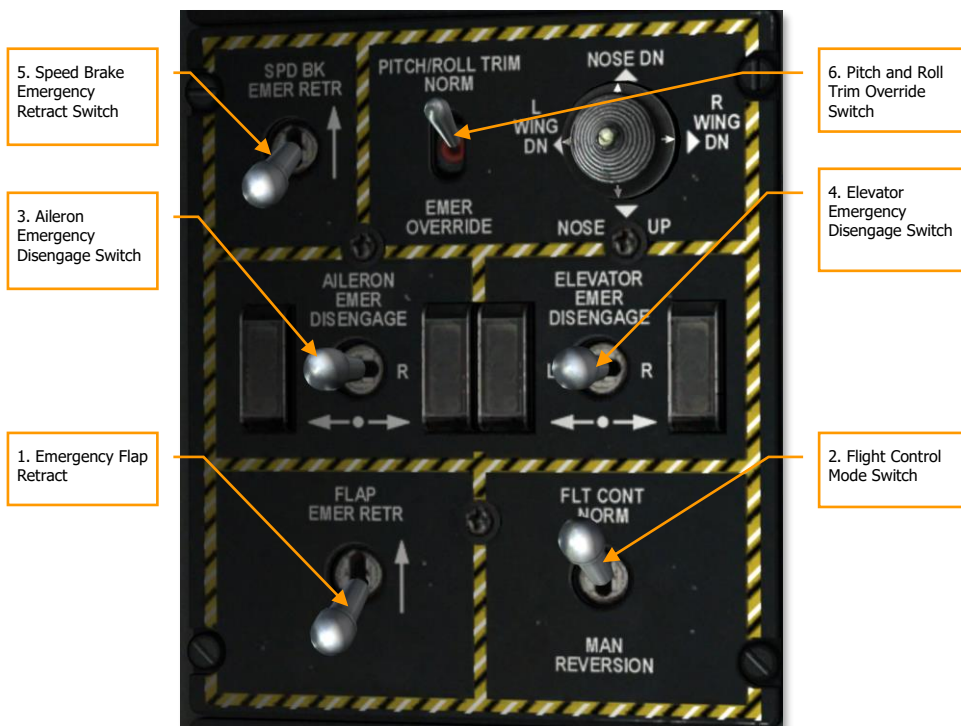
Emergency Flight Control Panel:**Figure 304. Emergency Flight Control Panel**

1. Emergency flap retract switch to aft
2. Flight control mode to NORM
3. Aileron emergency disengage switch to center position
4. Elevator emergency disengage switch to center position
5. Speed brake emergency retract switch to aft position
6. Pitch/Roll trim override switch to NORM

Throttle Quadrant Area:

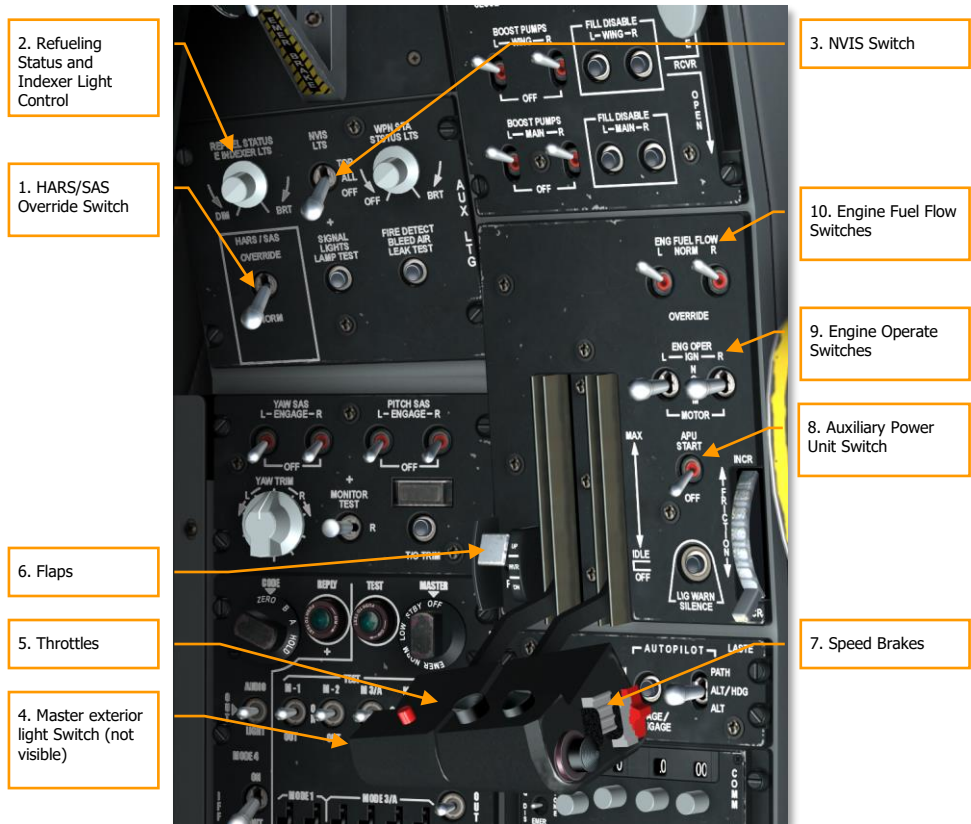

Figure 305. Forward Left Console

1. HARS/SAS override switch to NORM
2. Set refuel status and indexer light control
3. NVIS light switch to OFF
4. Master exterior light switch to aft (located on left throttle)
5. Throttles in OFF (full back) position
6. Set flap position to UP (left of throttles)
7. Speed brakes to closed position (speed brake switch on right throttle)
8. Auxiliary Power Unit (APU) switch to OFF

9. Engine operate switches to NORM
10. Engine fuel flow switches to NORM

Fuel System Panel:



Figure 306. Fuel System Panel

1. Main fuel boost pump switches to OFF
2. Wing fuel boost pump switches to OFF
3. Main fill disable switches are depressed
4. Wing fill disable switches are depressed
5. Air refuel control is CLOSE
6. Tank gate switch is CLOSE
7. Crossfeed switch is OFF

Front Dash

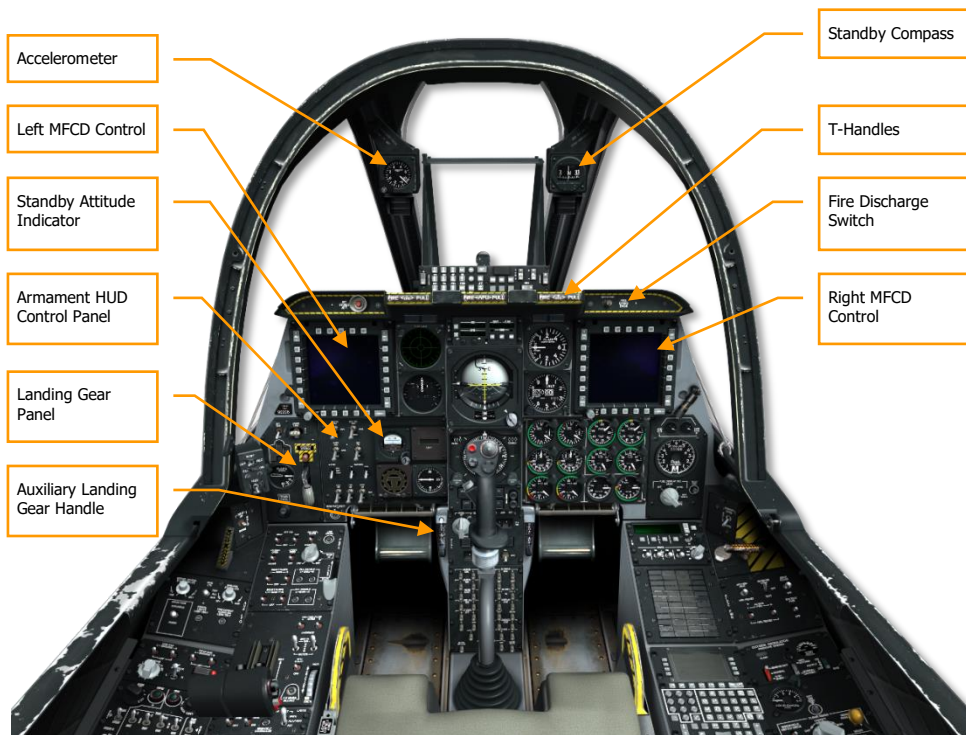

Figure 307. Front Dash

1. Both MFCDs are set to OFF
2. Standby Attitude Indicator is CAGED
3. Reset Accelerometer
4. Fire T-Handles are all in
5. Fire discharge switch is centered
6. Check Standby Compass
7. Auxiliary landing gear extension handle is in

Landing Gear Panel

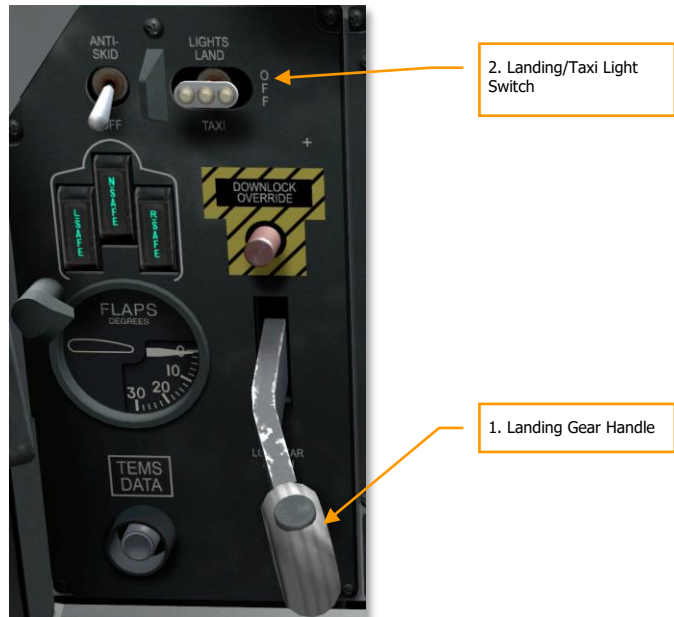

Figure 308. Landing Gear and Flap Panel

1. Landing gear handle is DOWN
2. Landing/Taxi light switch is OFF

Armament HUD Control Panel

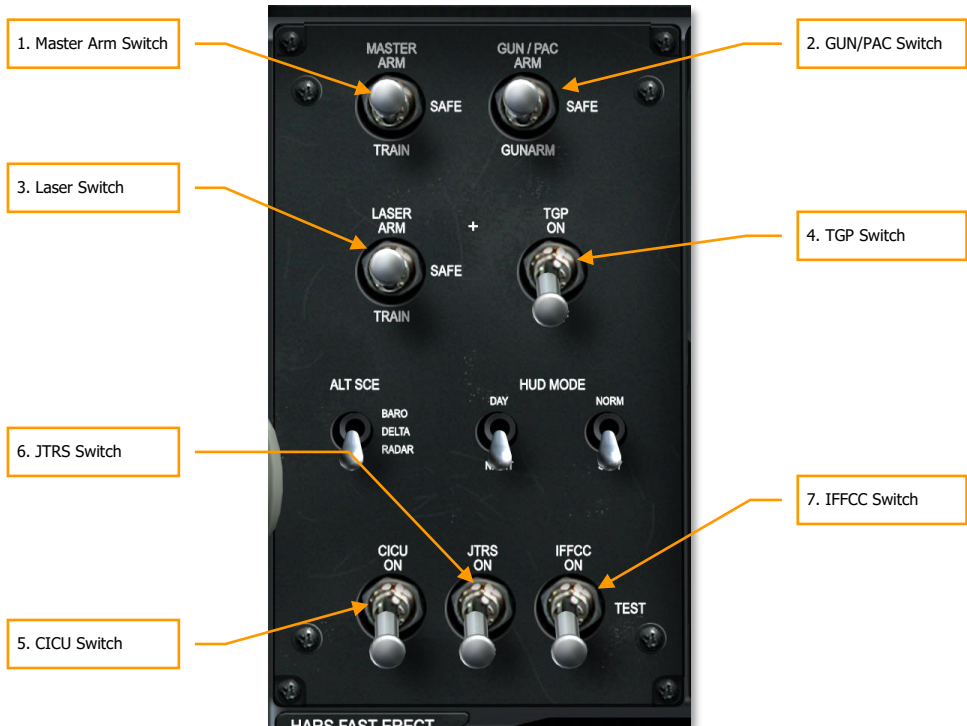

Figure 309. Armament HUD Control Panel

1. AHCP Master Arm switch set to SAFE
2. AHCP GUN/PAC switch set to SAFE
3. AHCP Laser ARM switch set to SAFE
4. AHCP TGP switch set to OFF
5. AHCP CICU switch set to OFF
6. AHCP JTRS switch set of OFF
7. AHCP IFFCC switch set to OFF

Right Console

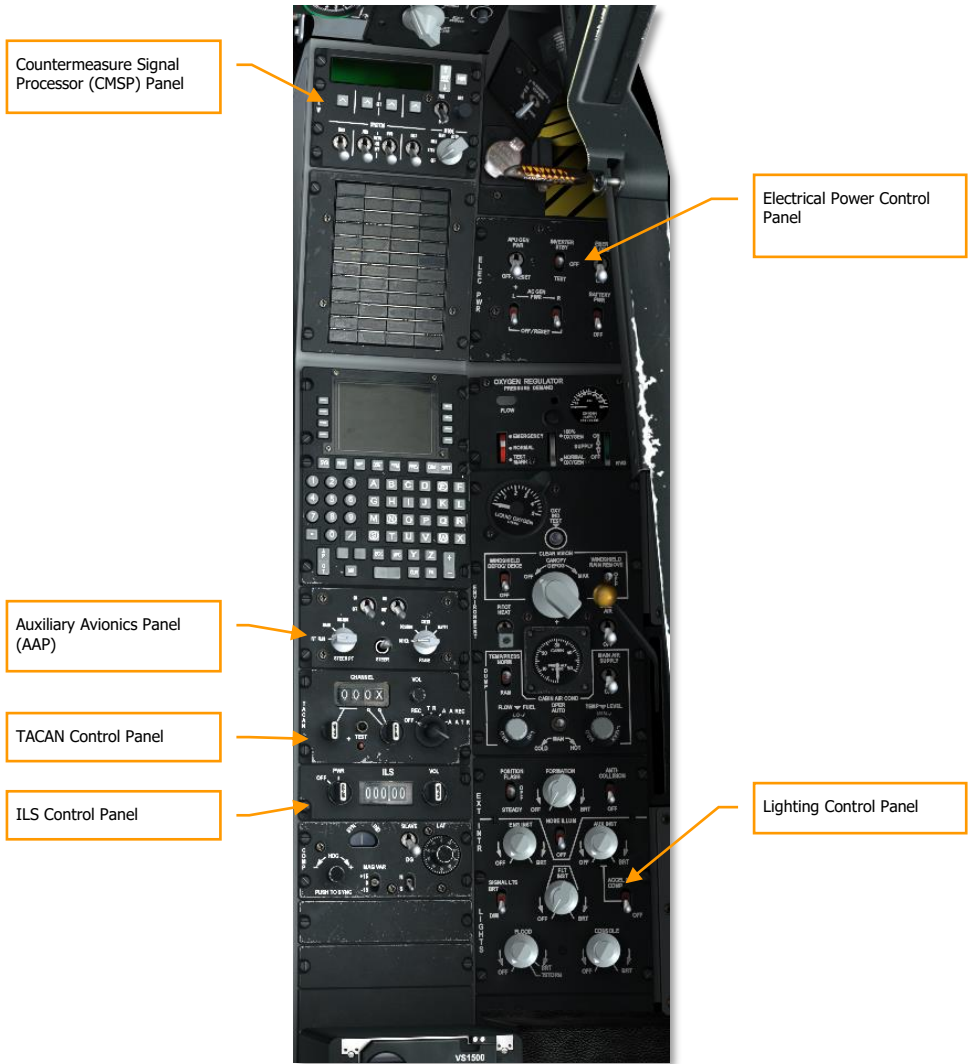

Figure 310. Right Console

Electrical Power Control Panel



Figure 311. Electrical Power Control Panel

1. APU generator switch to OFF/RESET
2. Inverter switch to OFF
3. AC generators switches set to OFF/RESET
4. Battery switch to OFF
5. Emergency flood switch set as desired

Countermeasure Signal Processor (CMSP) Panel



Figure 312. CMSP Panel

1. Mode dial set to OFF
2. All System switches set to OFF

ILS Control Panel



Figure 313. ILS Panel

1. ILS Panel Power Switch set to OFF

Auxiliary Avionics Panel (AAP)



Figure 314. Auxiliary Avionics Panel

1. CDU switch set to OFF
2. EGI switch set to OFF
3. PAGE knob set to OTHER
4. STEER PT knob set to MISSION

TACAN Control Panel



1. TACAN Mode Dial

Figure 315. TACAN Panel

1. TACAN Mode Dial set to OFF

Lighting Control Panel



Figure 316. Lighting Panel

1. Lighting control panel set as desired

Start

Electrical Power Start and APU

After completing your pre-flight check, you will need to initiate electrical power to the aircraft and start the APU.

Before starting the APU, you will need to enable electrical power. First ensure that the Battery Switch is set to PWR and the Inverter Switch to STBY.

Set the Battery switch to the PWR position. This will allow DC power to be drawn from the battery and supply the DC essential and auxiliary buses. The APU will draw from the DC essential bus to start it.

Set the Instrument Inverter Switch to the STBY position from the OFF position. This will allow APU generated DC power to be inverted to the AC buses that supply power to many of the instruments. When enabled, the INST INV caution light should extinguish.

If at night, enable the Emergency Flood Light switch to illuminate the cockpit.

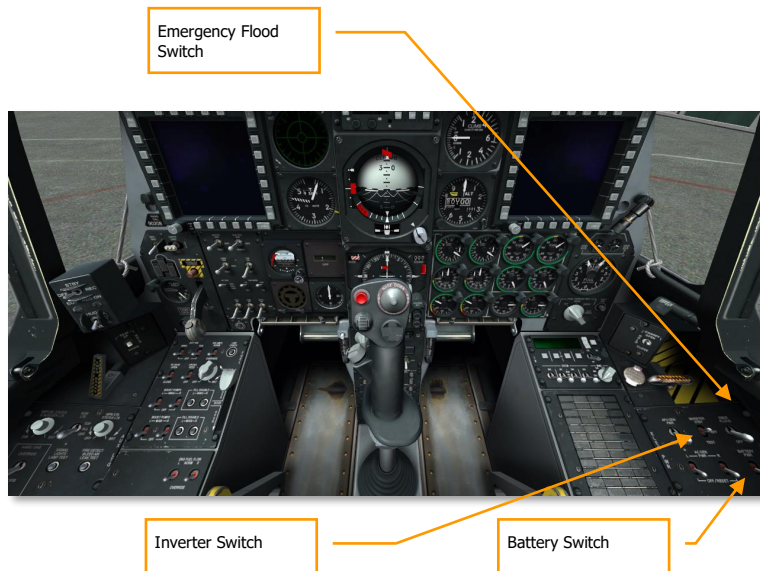

After doing so:

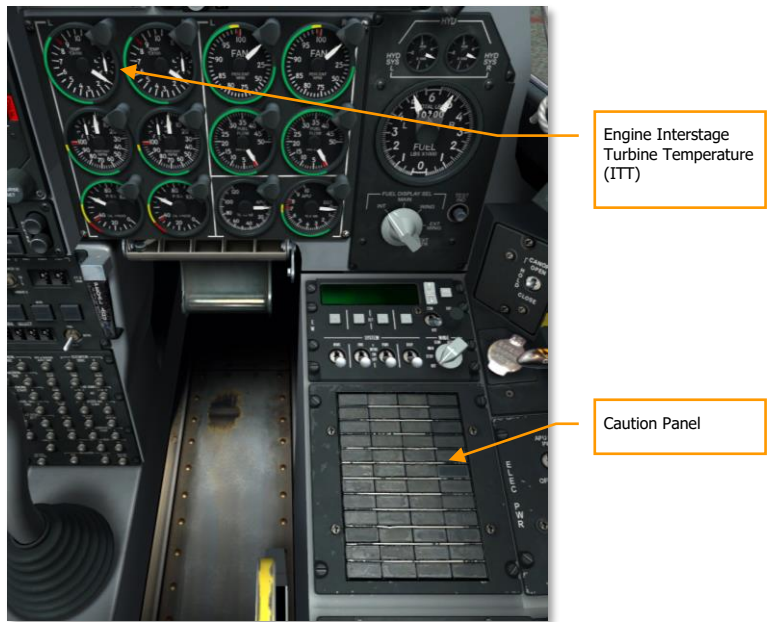

Figure 317. Right Front Dash and Console

- The INST INV, L/R ENG HOT lights on the caution panel should extinguish
- The engine ITT indicators should be below 150 °C

Do a final check of the cockpit of the following items:

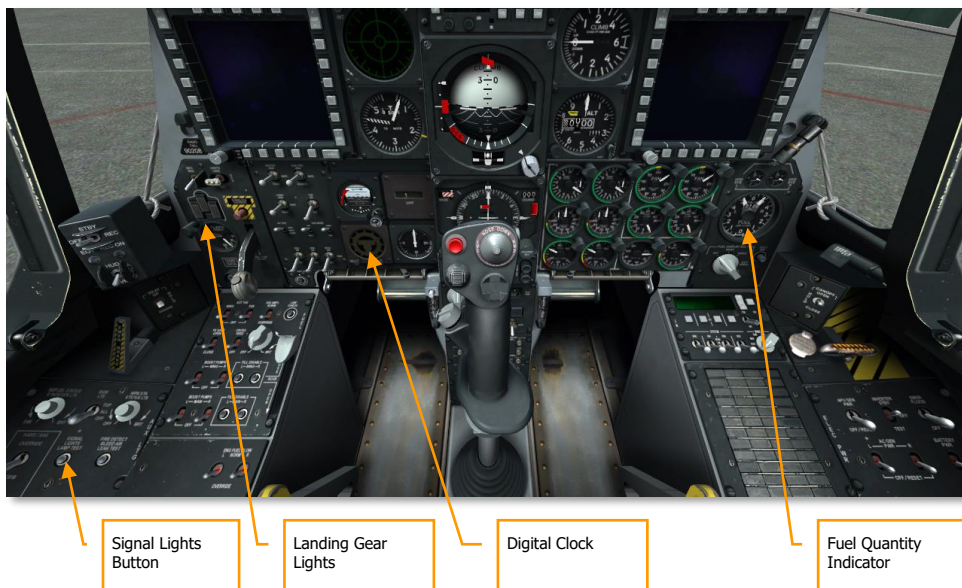

Figure 318. Lower Front Dash Area

1. Three green, down landing gear lights
2. Test the signal lights by pressing the Signal Lights button
3. Set the clock if needed
4. Test the fuel quantity indicator. Press the test button and the left and right pointers will indicate 3,000 and the totalizer will indicate 6,000
5. Set Oxygen supply to ON

With these items set, you will now begin the process to start the APU and engines:

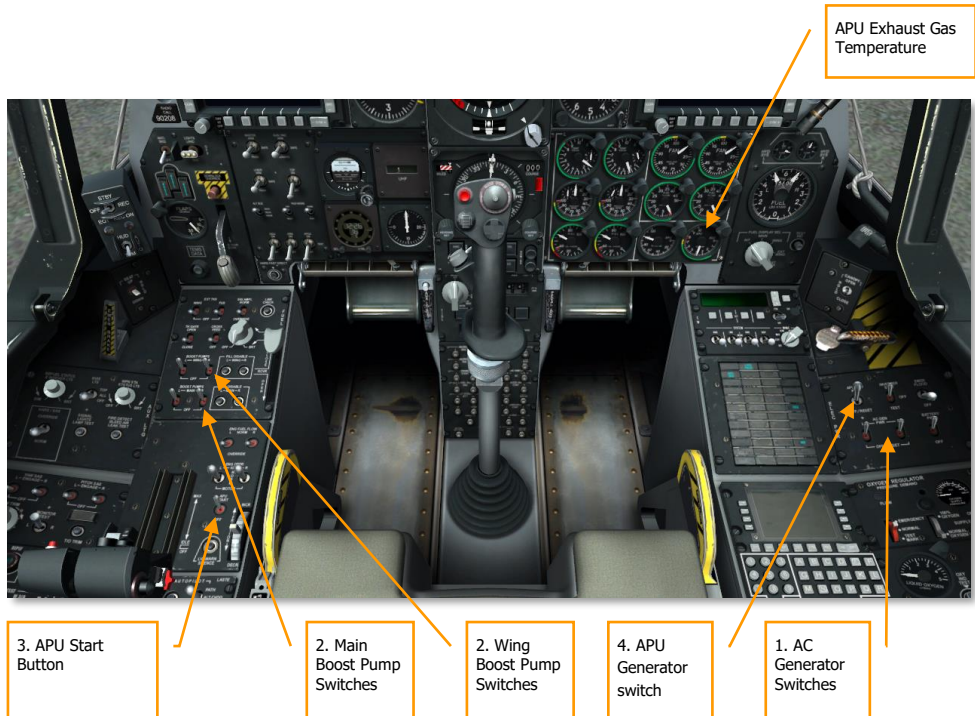

Figure 319. Forward Cockpit

Make sure that both AC Generator switches are in the PWR position. With these set, the generators will supply AC power to the AC buses once the engines are running and powering the generators.

Make sure that the Left and Right main and wing boost pump switches are enabled. These DC powered pumps will start to supply fuel to the engines once they are started.

Press the APU Start button to start the APU using DC power. Once stabilized, the APU will now be capable of providing bleed air to start the engines and drive the APU generator. The APU Exhaust Gas Temperature will briefly spike at 760 °C when it feeds the engine starter but will normalize between 400 and 450 °C when at idle. Stabilized RPM operation of the APU will be at 100%.

Set the APU Generator switch to the PWR position. This will allow the APU generator to power the aircraft.

Radio Set Up

To best communicate with other friendly units involved with the mission, you will want to set up your UHF and VHF radios according to the mission briefing. The last thing you will want to be doing when being shot at is configuring frequencies on the radios!

Most often you will have configured the radios when starting the aircraft, but if not, now is the time to do so. Mission frequencies will most often be listed in your mission briefing.

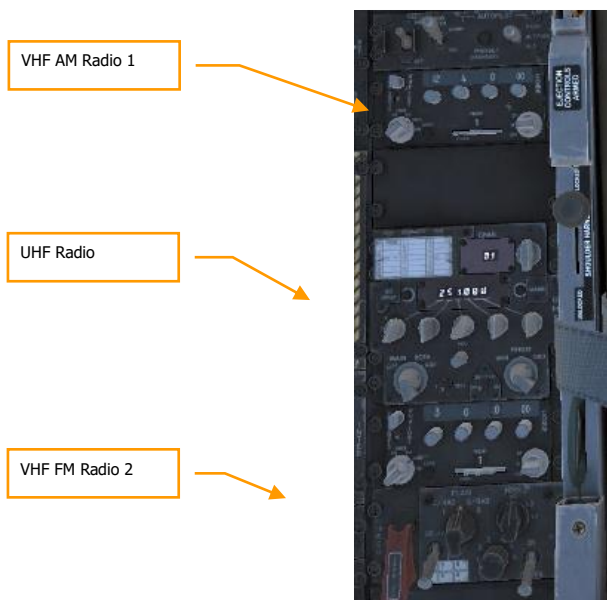

Figure 320. Left Console, Radios

While it is up to you to decide exactly how you want to assign your radios, we suggest the following:

VHF Radio 1 and 2

When getting ready for combat, VHF radios 1 and 2 are best assigned to other mission assets such as AWACS, other friendly flights, JTAC, etc. To set up the radios, you will want to do the following:

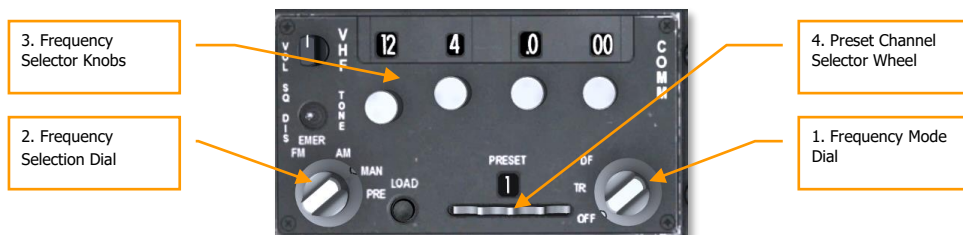

Figure 321. VHF Radio

1. Set the Frequency Mode Dial to the Transmit/Receive (TR) position.
2. Set the Frequency Selection Dial to either Manual (MAN) or Preset (PRE)
3. If the Frequency Selection Dial is set to MAN, use the Frequency Selector Knobs to enter the desired frequency of either the flight, AWACS or general mission frequency.
4. If the Frequency Selection Dial is set to PRE, use the Preset Channel Selector Wheel to select the preset frequency assigned to either the flight, AWACS, or general mission frequency.

Once the correct channels are set, you may use the Mic Switch on the HOTAS throttle to send a radio message on the selected radio:

- Mic Switch Forward. Transmit on VHF radio 1 (AM)
- Mic Switch Aft. Transmit on VHF radio 2 (FM)

UHF Radio

As with the VHF radios, you will want to make sure the UHF radio is set to the proper frequency. The UHF radio will most often be used to communicate with your wingmen.

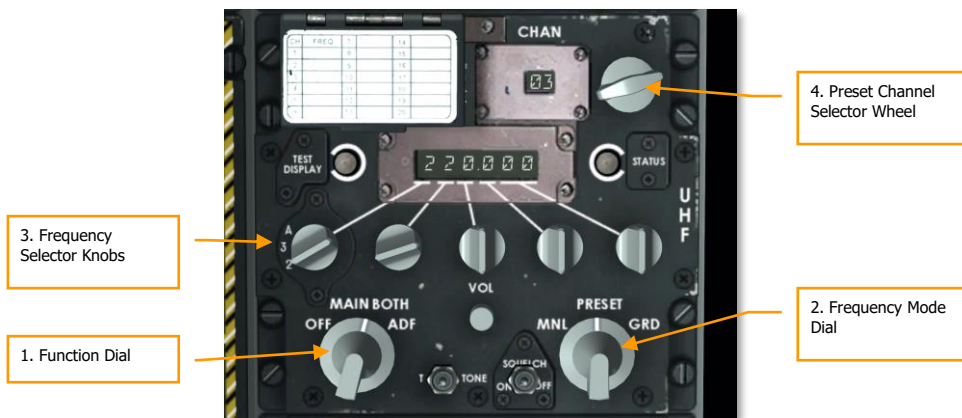

Figure 322. UHF Radio

1. Set the Function Dial to the BOTH position. In this position, the UHF radio will allow you to send and receive communications and monitor (receive only) communications on the guard channel.
2. Set the Frequency Mode Dial to either Manual (MNL) or PRESET.
3. If the Frequency Mode Dial is set to MNL, use the Frequency Selector Knobs to enter the desired frequency of the mission participant.
4. If the Frequency Mode Dial is set to PRESET, use the Preset Channel Selector to select the preset frequency assigned to mission participant.

Once the correct channels are set, you may use the Mic Switch on the HOTAS throttle to send a radio message on the selected radio:

- Mic Switch Down. Transmit on UHF radio

Set Up Auxiliary Avionics Panel (AAP)

This small panel below the CDU on the right console needs to be set up for the navigation system. It's a good idea to do this early as it gives the inertial navigation system time to align.

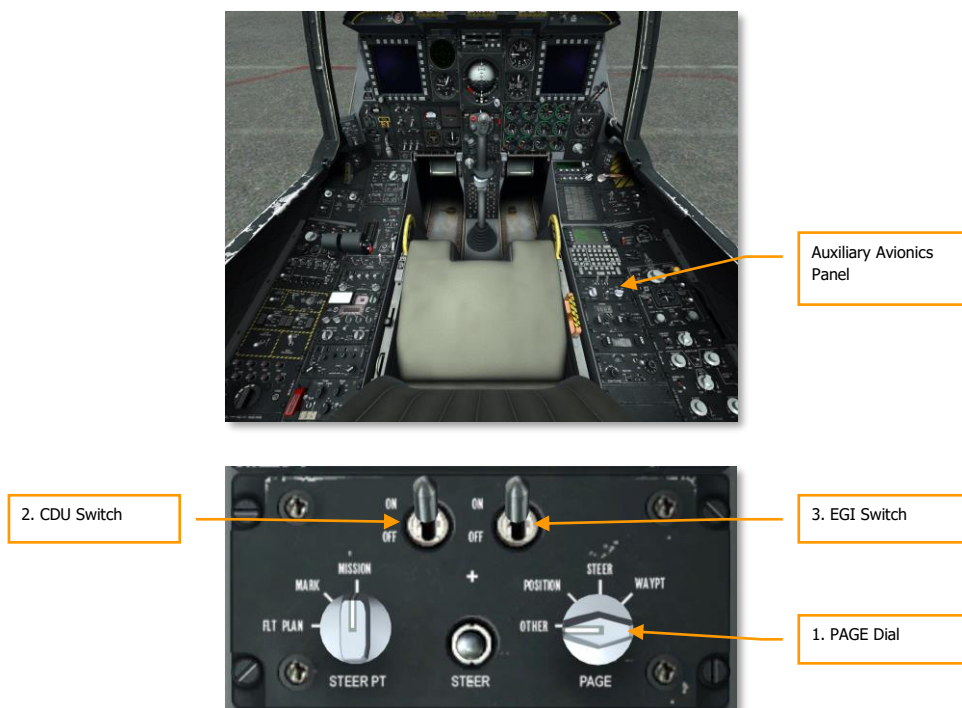

Figure 323. Set Up Auxiliary Avionics Panel

1. Rotate the PAGE dial to the OTHER setting. This will allow us to view the CDU Built In Test (BIT) and initialization check when the CDU is powered-up.
2. Move the Control Display Unit (CDU) switch to the ON position. This will provide power to the CDU panel located above the AAP. On the CDU display window, the CDU startup BIT Test will initiate. When complete, the CDU will display the Alignment page.

3. Move the Embedded GPS/INS (EGI) switch to the ON position. This will initiate the inertial navigation system and global positioning system and start the alignment process that can take several minutes.

Left Engine Start

With APU and electrical systems running normally and the navigation system aligning, we will start the left and right engines one at a time. Both engines will use the APU to start them. When on the ground, you should not use one engine to start the other.

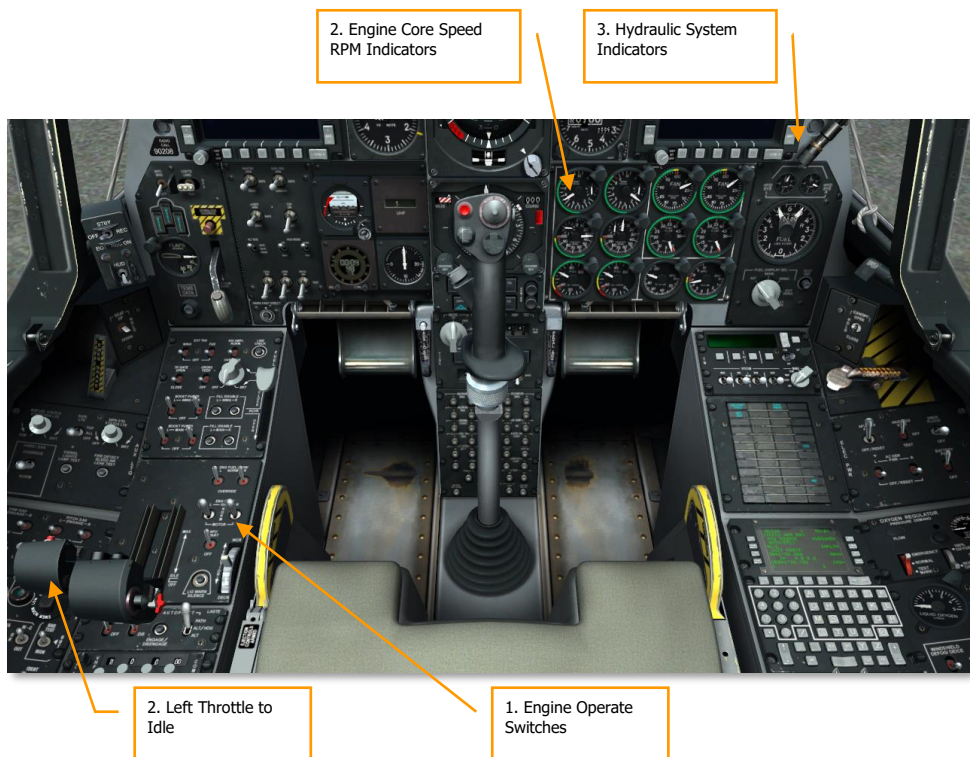

Figure 324. Left Engine Start

1. Confirm that both Engine Operate switches are in the NORM position.

2. Move the Left throttle from the OFF to the IDLE (56% core RPM) position. This will automatically initiate a left engine start with the automatic ignition. Once moved to idle, the DC fuel boost pumps will activate to feed that engine.
3. Check flight control movements and monitor the left hydraulic system indicator on the Fuel Quantity and Hydraulic Indicator Panel. Normal pressure should be between 2,800 and 3,350 psi.

Right Engine Start

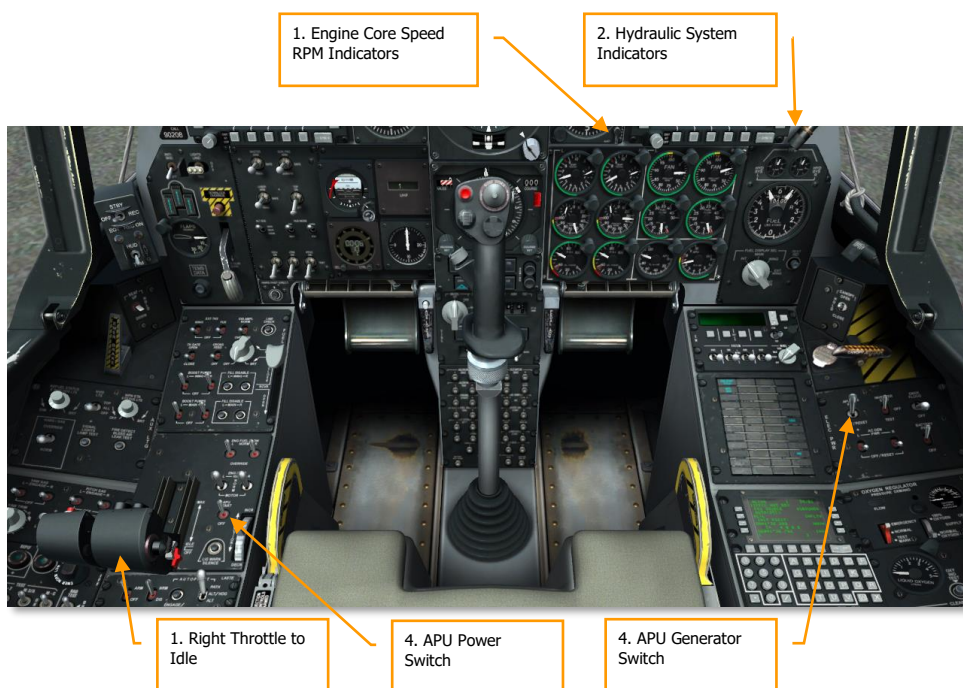

Figure 325. Right Engine Start

1. Once the Left engine has stabilized, move the Right throttle from the OFF to the IDLE position to start that engine. The APU bleed air will also be used to start the second engine and not bleed air from the first engine as you might assume.

Note: When starting the engines, the Interstage Turbine Temperature will spike at 900 °C but will stabilize between 275 and 865 °C.

2. Check the left hydraulic system by setting the flaps to the down (DN) position and then back to full up. Monitor the hydraulic system indicator.
3. Check the speed brakes by partially opening them and then halt them with the emergency retract switch, and then continue to open to full. Cycle the flight controls to check for any bindings. Close the speed brakes.
4. With both engines running normally, you may set the APU switch to OFF and the APU Generator switch to off as all needed power is now being supplied by the engines and AC generators. Keeping the APU generator on at this point will result in a Master Caution warning.

Trim Check

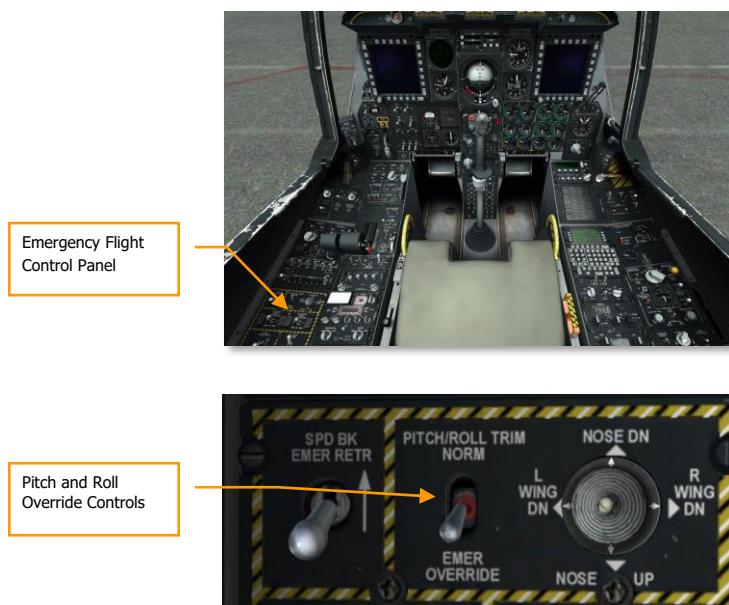

Figure 326. Trim Check

1. Use the trim hat on the control stick to check trim movement.

- From the Emergency Flight Control Panel, place the Pitch/Roll Trim switch to the Emergency Override position and use the hat to manually test trim. When complete, place the switch back to the NORM position.

Test Pitot Tube Heating

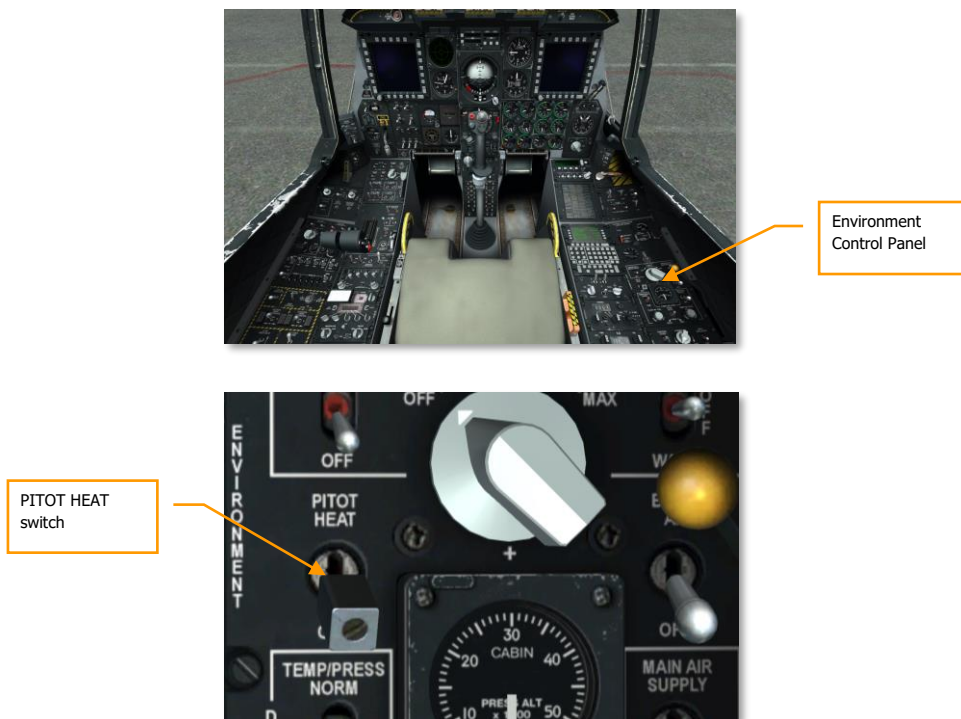

Figure 327. Test Pitot Tube Heating

- Enable PITOT HEAT switch on the Environment Control Panel. Then turn off for taxi. Keeping pitot on too long when stationary on the ground can lead to overheating.

Enable IFFCC

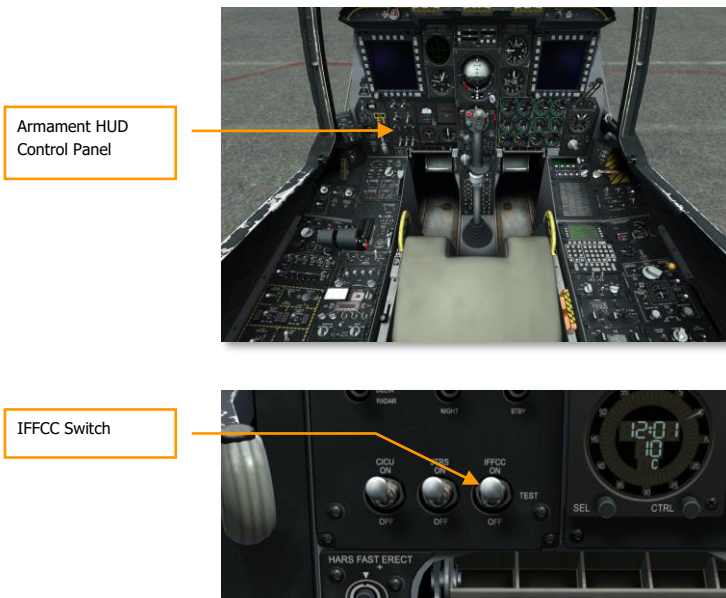

Figure 328. Enable IFCC

1. From the Armament HUD Control Panel (AHCP) on the front dash, move the Integrated Flight and Fire Control Computer (IFFCC) switch from the OFF to the TEST position.
2. From the IFFCC Test Menu, set up the CCIP Consent, AAS, 30 MM, and Display Modes as desired.
3. Move the IFFCC switch to the ON position to enable the Heads-Up Display (HUD).

Enable CICU



Figure 329. Enable CICU

1. From the AHCP, move the Central Interface Control Unit (CICU) switch to the ON position.

Turn on the MFCDs and Load Data

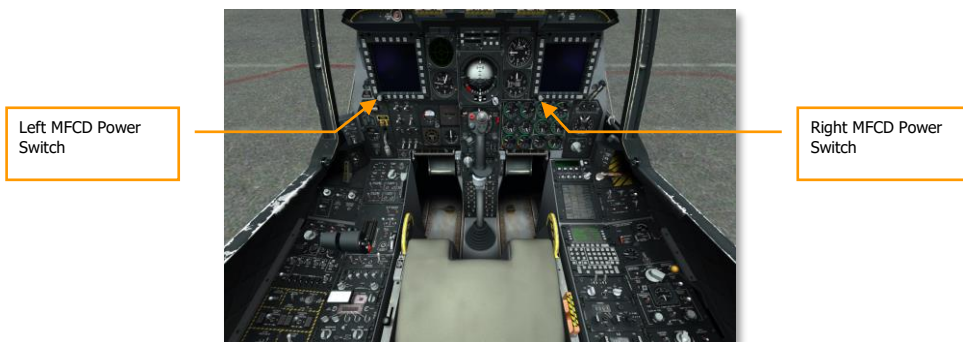

Figure 330. Turn on the MFCD's and Load Data

Rotate the DAY (or night) knob from the OFF position on each MFCD. On both MFCD, the DTS UPLOAD page will be displayed. From here you can load flight and weapons data determined in mission planning. Select the LOAD ALL option to load all needed mission data. After pressing the button, the load will be complete when the asterisk mark returns next to the other DTS upload options.

Load Flight Plan

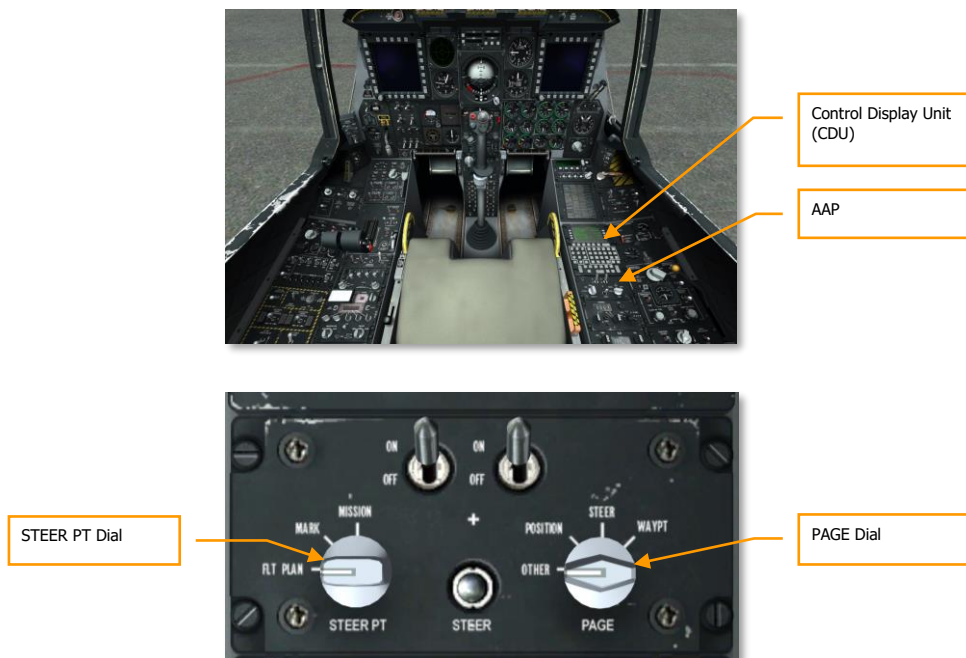

Figure 331. AAP Load Flight Plan

With the navigation data loaded, you may load a flight plan. To do so:

1. Move the STEER PT dial on the AAP to the FLT PLAN position
2. Make sure that the PAGE dial on the AAP is set to OTHER



Figure 332. CDU FPM Button

3. Select the Flight Plan Menu (FPM) page on the CDU



Figure 333. Flight Plan Build Page

You may now enter a flight plan or select Flight Plan Build (FPBUILD) and create your own from mission waypoints created in the mission planner.

Once a flight plan is loaded, you will see the plan displayed on the Tactical Awareness Display (TAD) when selected.

Select TAD Page



Figure 334. Select TAD Page

4. From one of the MFC, select the Tactical Awareness Display (TAD) page.
If a flight plan has been loaded, the waypoints and lines will be displayed.

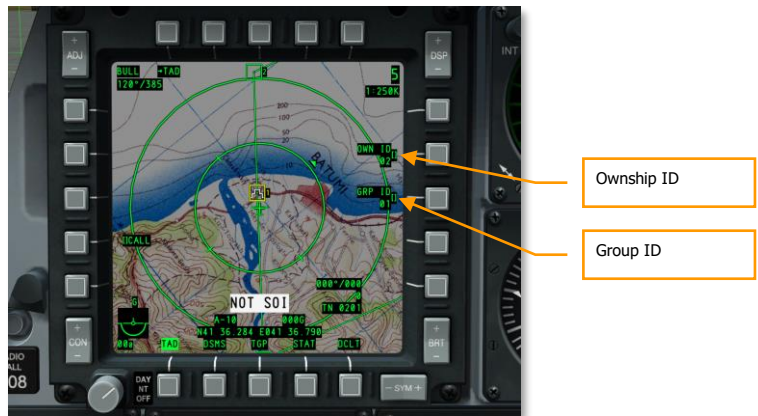

Figure 335. Datalink Network Configuration Page

5. Select the Network (NET) OSB, enter your ownship ID and group ID in order to be linked into the datalink network.
6. Confirm flight members and other friendly units appear on your TAD as datalink symbols.
7. Confirm datalink by hooking a flight member.

Enable the Targeting Pod (TGP)

If a targeting pod has been loaded on your aircraft, you will need to activate it and start the process to cool down its infrared camera.

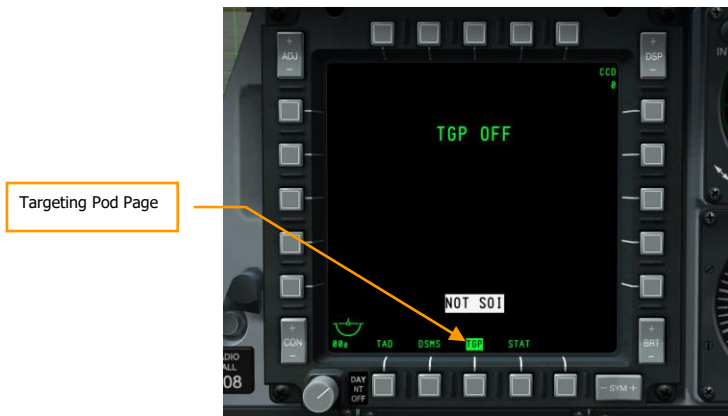

Figure 336. MFCD TGP Page

1. On an MFCD, select TGP and a TGP OFF message will be displayed.



Figure 337. AHCP TGP On

- From the AHCP, move the TGP switch to the ON position. Initially, a NOT TIMED OUT message will display but after a few moments the TGP will start to power on and go through its Built In Test (BIT) with a FLIR HOT message.

The TGP will be available for operation once the Standby (STBY) page is displayed.

Select STAT Page

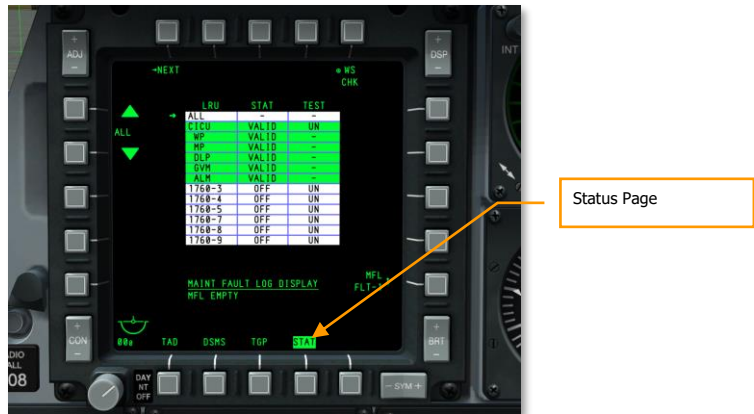

Figure 338. Select STAT Page

- From one of the MFC, select the Status (STAT) OSB to check status of aircraft systems and configure slew rates.

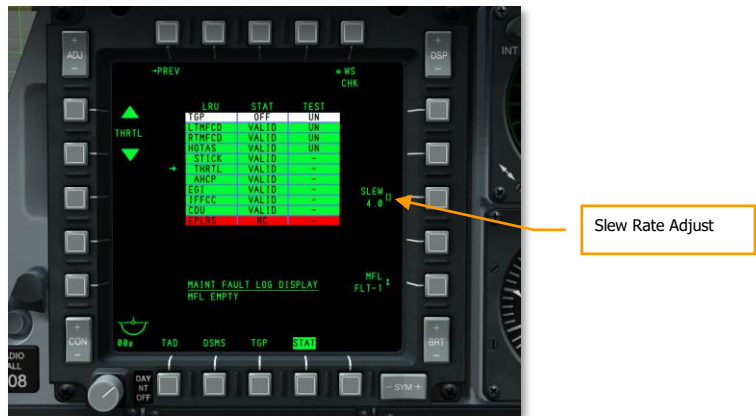

Figure 339. STAT Page 2

- On the second page of the STAT page, scroll down to HOTAS/THRTL and adjust the SLEW rate for the cursors as desired.

Select DSMS Page

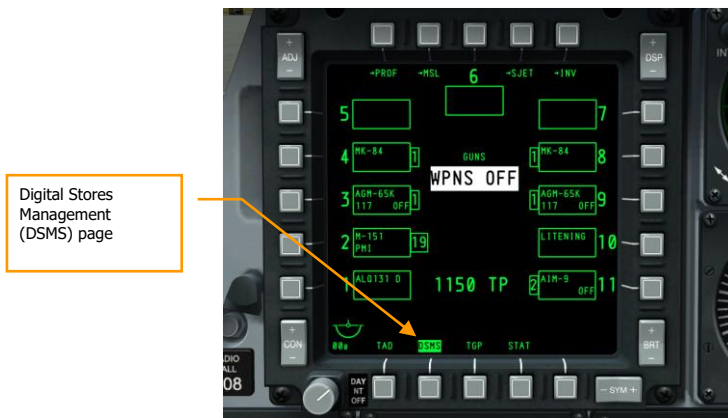

Figure 340. MFCDSMS Page

1. From one of the MFCD, select the Digital Stores Management System (DSMS) display.
2. Check that all stores data and profile data was transferred from the Data Transfer System (DTS) correctly. There should be no red indications.

You may also wish to manually adjust profile data.

Set Up Countermeasure Systems

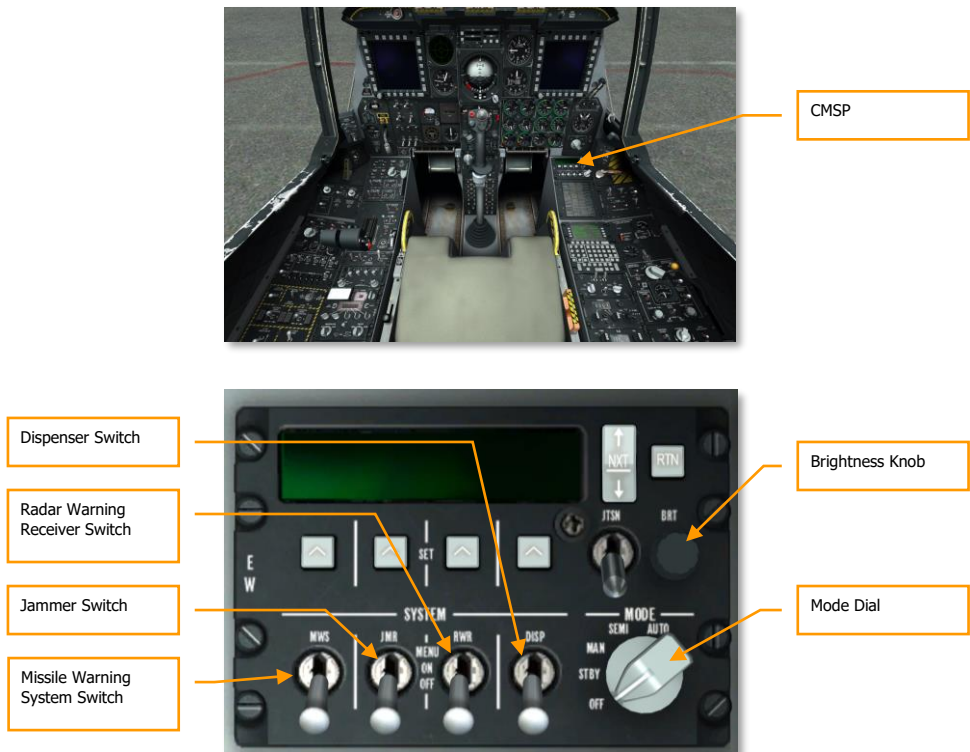

Figure 341. Set Up Countermeasure Systems

1. From the Countermeasure Signal Processor (CMSP) panel on the right console, select Standby (STBY) mode to power on the system.
2. Adjust the brightness knob as needed.

3. Set the Dispenser (DISP) switch to Menu and review programs and add additional ones if desired.
4. Return the DISP switch to the ON position.
5. Move the Radar Warning Receiver (RWR), Jammer (JMR), and Missile Warning System (MWS) switches to the ON position to power them on.

EGI CDU Set Up

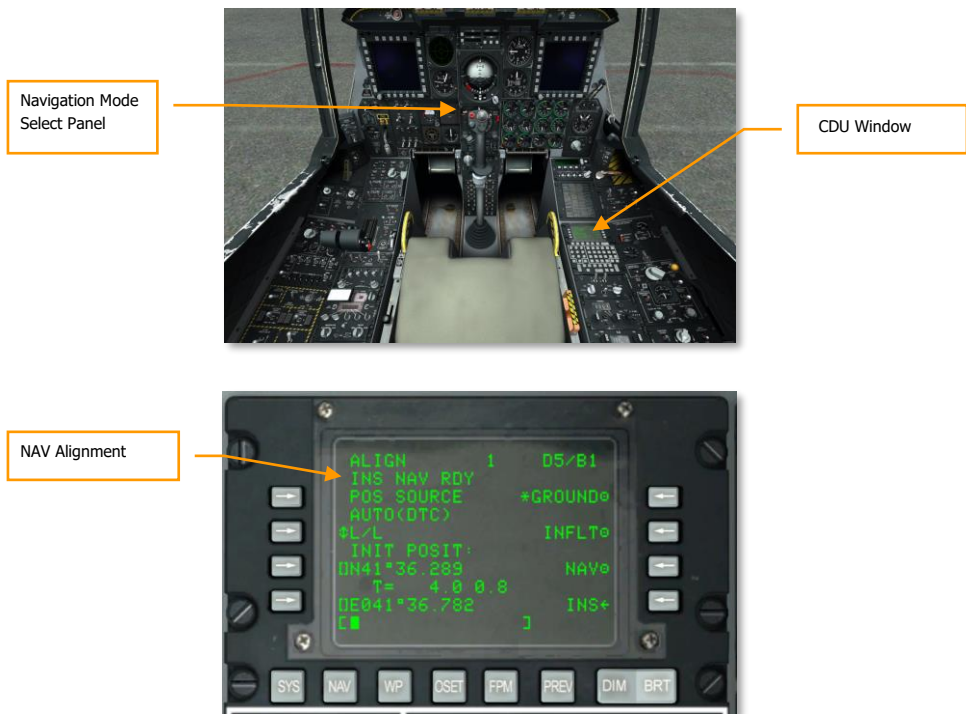

Figure 342. CDU Navigation / Align Sub-page

1. Once the EGI has completed its alignment process, indicated by the **flashing INS NAV RDY** message on the CDU, you need to change alignment from GROUND to NAV on the CDU. Once you do so, the flashing NAV light on the caution panel will extinguish.

Navigation Mode Select Panel (NMSP) Set Up



Figure 343. Navigation Mode Select Panel

1. From the Navigation Mode Select Panel (NMSP) on the lower center front dash, select the EGI and TCN (TACAN) buttons. This will allow navigation output in regard to the EGI and TACAN beacons rather than the default HARS navigation.

LASTE

2. Set the EAC switch to ARM and the radar altimeter to the NRM (normal) position.



Figure 344. LASTE Panel

Enable Stability Augmentation System (SAS)

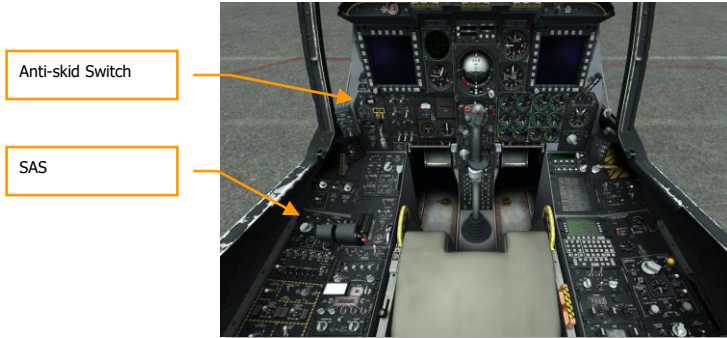



2. Anti-skid Switch

Figure 345. SAS and Anti-skid Switch

1. Confirm YAW and PITCH SAS L and R switches are engaged. Position the disengage switch left and watch YAW SAS disengage. Position to the right watch YAW SAS disengage.
2. Engage all SAS and anti-skid. Press the paddle switch on the control stick to confirm all SAS and Anti-skid disengage. Engage all SAS for remainder of flight.

Close Canopy

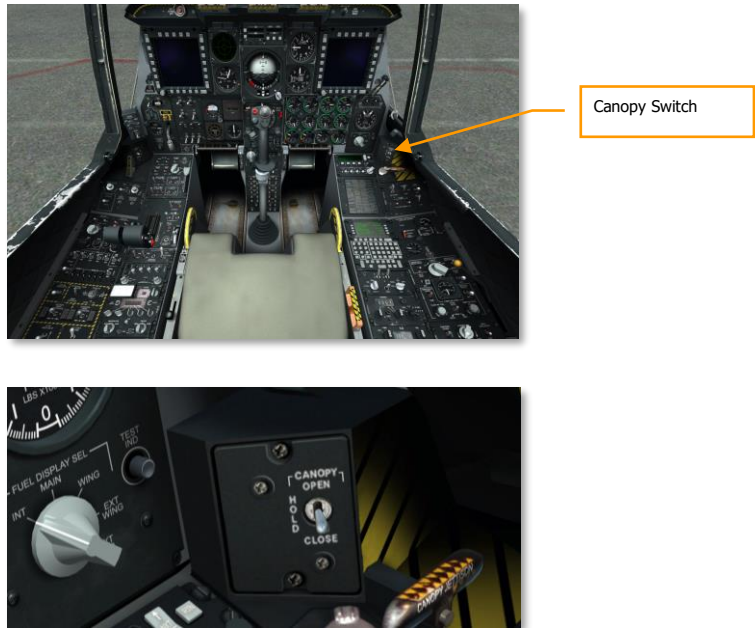

Figure 346. Close Canopy

1. Press and hold the Canopy Switch in the down position to close the canopy.
2. Confirm Canopy Unlocked light extinguishes.

NAVIGATION



NAVIGATION

The A-10C uses a variety of navigation methods to direct you to mission locations. Depending on the mission or stage in the mission, you may use different navigation sources. While we have reviewed many of the navigation systems in the Cockpit Controls chapter, this Navigation chapter will review the practical application of these systems.

Navigation Mode Select Panel (NMSP)

The primary means of selecting sources of navigation is the NMSP. From here you can determine what navigation is displayed on the HUD or feeds data to your flight instruments like the ADI and HSI. When a selection is active, the green triangle on the button will light.

The two primary systems that can direct heading and attitude data are:

- **HARS** (Heading Attitude Reference System). This and the EGI button cannot be active at the same time. Pressing one will deactivate the other.
- **EGI** (Embedded GPS INS). This and the HARS button cannot be active at the same time. Pressing one will deactivate the other.

Both of these systems provide data to the HUD, ADI and HSI.



Figure 347. Navigation Mode Select Panel

TISL (Target Identification Set Laser). The Pave Penny pod has been removed from the A-10C II and TISL navigation is not available.

TCN (TACAN). From the TACAN control panel, you may select the desired TACAN station to navigate to. Once entered and the station is within operative range, heading and range information is displayed on the HSI and ADI.

ILS (Instrumented Landing System). From the ILS control panel, you may select the desired ILS station to navigate to. Once entered and the station is within operative range, heading and range information is displayed on the HSI and ADI.

Note: TISL, TCN, and ILS are all mutually exclusive. Only one of these three can be operating at one time because all three use the CDI on the HSI.

STR PT (Steer Point). The STR PT function makes the CDI on the HSI operate in relation to the steerpoint. When you then set a course to the steerpoint, the CDI will center. This can be a useful function when landing at night in combat at an airfield without an ILS glide slope. In such a situation, you can make the end of the runway the steerpoint and then set the EGI up for "3-D NAV" so you can also use both the CDI and the steering bars to give heading and a "GPS" type glide path to touchdown.

ANCHR (Anchor Point, aka Bullseye). When active, the HSI and ADI needles will point to the Anchor Point. The Anchor point is set on the CDU.

UHF Homing Light. Indication of UHF ADF navigation.

FM Homing Light. Indication of TISL or VHF DR homing.

In the following sections we will discuss each of these navigation and homing data sources.

Heading Attitude Reference System (HARS) Navigation

The Heading Attitude Reference System (HARS) is a gyro-platform navigation system that served as the initial, primary navigation system of the A-10A. As the A-10A evolved into later versions, EGI was added and HARS has become a back-up system to the Inertial Navigation System (INS) when the EGI is inoperative. When the INS of the EGI is not available, HARS is selected automatically on the Navigation Mode Select Panel. You can also select it manually when EGI is working, but there would be no reason to do so. As a backup system, HARS can provide good heading and attitude information, but it can become inaccurate with hard maneuvering or if taken out of Slave to compass mode. It also cannot provide a TVV on the HUD.

When HARS is active, it provides or removes the following data:

- Pitch and roll signals to the ADI
- Heading data to the TACAN
- Heading data to the compass card on the HSI
- Bank angle to the SAS
- Pitch and roll angle on the HUD
- The Total Velocity Vector (TVV) will be removed from the HUD
- The HARS caution light on the Caution Panel will light
- A HARS failure is indicated:
- The ADI OFF Flag will appear
- HUD roll tabs will not be displayed

HARS Fast Erect

Located on the lower, left front dash is the HARS Fast Erect button. Pressing this switch will eliminate errors that have accumulated regarding HARS attitude display data (ADI and HUD). Over time and with changes to pitch and heading, the HARS gyro will accumulate errors and the HARS output and the remote compass transmitter will become out of synch. To properly perform this operation and avoid false attitude data, a Fast Erect should only be done when the aircraft is straight and level and not accelerating. When the button is pressed, you will see the following indications:

- ADI Power Off flag will appear
- HSI Power Off flag will appear
- Pitch and roll bars on HUD will be removed

HARS Modes of Operation

HARS can operate in one of two master modes that are selected from the HARS Master Mode switch.



Figure 348. HARS Panel

SLAVE mode. SLAVE mode, also called gyro-magnetic mode, allows the HARS gyro to be fed by the compass signal. The compass shows heading immediately (may be very jerky under some maneuvers) and provides the Gyro constant updates and acts to dampen the HARS Gyro system. Because of this, prolonged, hard maneuvering can cause errors in the compass data sent to the HARS Gyro. However, after a few minutes of straight and level flight, the errors will be corrected. If you want to immediately correct the heading indication (according to the immediate compass indication), you can push HDG knob on the HARS panel. This forces the Gyro to align (synchronize) with the compass much more quickly (10 to 100 times faster compared to normal Slaved operation).

DG mode. If Slave mode fails, the DG (Directional Gyro) mode acts as a backup. In DG mode the Gyro is uncoupled from the compass and works autonomously. Due to this, the Gyro will accumulate errors and not have the self-correction like on Slave mode from the compass. In this mode, you must rotate the Heading and Push to Sync control knob until the HSI heading aligns with the standby compass.

Embedded GPS INS (EGI) Navigation

The EGI is the primary navigation system of the A-10C and provides accurate attitude, navigation, and vertical and horizontal steering information. If EGI fails, HARS can be used as a backup. The Control Display Unit (CDU) is the primary interface device to the EGI but can also be mirrored to an MFCD as the CDU Repeater Page.

Much of the functionality and CDU page flow was discussed in the EGI chapter. In this Navigation chapter we will discuss the practical application of using the CDU EGI for navigation purposes.



Figure 349. Control Display Unit (CDU)



Figure 350. Auxiliary Avionics Panel (AAP)

Selecting a Waypoint

In this section we will discuss how to select a waypoint from the CDU database. Each waypoint is assigned a numeric and a name and range from 0 (initial position) to 2,050. A waypoint is an arbitrary geographic coordinate along with an elevation. It is important to understand that any waypoint can be set as the current steerpoint or anchor point. A selected waypoint in itself does not provide any flight direction data on the HUD, ADI, or HSI. To provide such steering information, you must set the waypoint as the steerpoint.

To select a waypoint, you have several choices depending on the settings of the AAP STEER PT and PAGE dials.

When the AAP PAGE dial is set to WAYPT:

When this is set on the AAP, you will be provided waypoint number, name, Time to Go (TTG), magnetic heading, and distance to the selected waypoint.



Figure 351. WAYPT Page

In the top right corner of the CDU Display Window will be shown basic navigation data of the selected waypoint. This three-line data block from top to bottom includes: Name of waypoint, Time to Go to waypoint, and magnetic heading / distance. **If you wish to change the waypoint, type in the name of the waypoint you want on the CDU keypad and then press the top right Line Select Key (LSK).** Upon doing so, the waypoint data block will change to the selected waypoint.

In the top left corner of the CDU Window is displayed the number of the selected waypoint. **To select a new waypoint, you may enter the new waypoint number on the CDU Keypad and then press the top left LSK.**

To view more detailed information about the selected waypoint, press the LSK next to the WAYPOINT label on the left side of the window.



Figure 352. Waypoint Information Page

In addition to manually entering the waypoint name or number, you may also use the \pm Rocker Switch on the CDU to cycle through waypoints in the order they are stored in the CDU database.

When the AAP PAGE dial is set to OTHER:

When the AAP PAGE dial is set to OTHER and regardless of the position of the AAP STEER PT dial, you can select the WAYPOINT details page by default and select a new waypoint by either entering a new waypoint number or entering a new waypoint name.

When the AAP STEER PT dial is set to either MARK or MISSION, you may also use the \pm Rocker Switch on the CDU to cycle through waypoints in the order they are stored in the CDU database.

Selecting Waypoints from HUD

In addition to using the CDU to select waypoints, you can also use the HUD and HOTAS to cycle through waypoints. When the AAP STEER PT dial is set to MISSION and HUD is SOI, you can cycle through the mission waypoints using **DMS Up or Down Short** on the control stick. This assumes you do not have a Flight Plan loaded.

Creating a New Waypoint

During a mission, there may be occasions when you want to add a new waypoint to the CDU database. The easiest way to do this is to select the waypoint page first:

1. Set the AAP PAGE dial to WAYPT and then select WAYPOINT branch from the WP INFO page
2. Set the AAP PAGE dial to OTHER and from the WP Function Select Key, select the WAYPOINT branch from the WP MENU page
3. With the waypoint page selected, select the "Copy to available mission point" LSK (?6 as shown in image below). This will copy the contents of the selected waypoint into an available mission point slot that is not currently being used (slot 6 in the case below).



Figure 353. Waypoint Information Page

3. We now need to create the properties of the new waypoint:
 - 3.1. Enter the elevation of the new waypoint in feet using the keypads/scratchpad and press the LSK next to the elevation field (EL).
 - 3.2. Enter the latitude of the new waypoint using the keypads/scratchpad and press the LSK next to the latitude field (N or S).
 - 3.3. Enter the longitude of the new waypoint using the keypads/scratchpad and press the LSK next to the longitude field (E or W).
 - 3.4. Enter a unique name for the new waypoint using the keypads/scratchpad and press the LSK next to the name field.

Note: You can use either the UFC or CDU keypads to enter data into the scratchpad.

Once complete, you will have a new mission waypoint in the database.

UTM and MGRS Coordinates Explained

The world is divided into large grid zones. They're given a number from 1 to 60 based on their east-west position (longitude) and a character based on their north-south position (latitude).

You can then basically give any coordinate as a combination of a grid zone and the distance east and north from the southwestern corner of that grid zone. 38T and two longish figures, for example. This is the UTM system.

However, UTM is rather complex to work with. To make it easier, the MGRS was introduced. Each grid zone is divided into a large number of 100,000 by 100,000-meter grid squares. These grid squares are given designators based on their north-south and east-west position within the grid zone, using one character for north-south and one character for east-west. AM, MM, DL etc.

Now you can point out an arbitrary 100,000 by 100,000-meter square anywhere on the planet, using a designator such as 38T ME.

From there, you just need to be able to designate a certain smaller square within that square, in order to point out targets. You do this just in the same way as you did within the grid zone using UTM, by measuring the distance east and then north of the southwestern corner of the grid square.

As the square is 100 km across, you need two figures per coordinate (east/north) to give 1 km precision (0-99 km east/north of SW corner). If 10 km precision is enough, you only need one figure. The first ten km east/north of the SW corner is then 0, the next ten 1 etc.

For pointing out targets, you will generally need to get down to ten-meter squares. As there are 100,000/10 ten-meter squares to each side of the 100,000 m two-character grid squares, you then need four digits (0-9999) for the easting, and another four for the northing.

For one meter precision, you need five digits.

A full MGRS coordinate consists of the grid zone, grid square and finally the easting and the northing written together as one long string of digits. Frequently, the grid zone is omitted once it is assured that everyone else is using the same grid zone.

38T ME04586742

This would mean a ten-meter square (four digits for easting/northing respectively) within grid square ME in grid zone 38T.

To find the position, you divide square ME into ten-meter squares and find column 458 from the western side. Then you'd find row 6742 from the southern edge of square ME. In reality, there are supporting lines in the maps making finding these coordinates easy. You're really finding a point 4580 m to the east and 67420 meters to the north, and then you know the object for which the coordinate is given to be in the 10 by 10 m square to the NE of this point.

Entering UTM Data as New Waypoint

The JTAC will give you a UTM or Lat/Long coordinate during the 9 line, and if you have your SA Link net settings correct, you will also get a data linked target identifier in your TAD (a red triangle). The following is based on JTAC giving you a UTM coordinate.

Use a mission data card to get all the info on the UTM coordinate and the specific weapon, direction of attack, direction of egress and weapon requested.

To make the UTM coordinate provided by JTAC into a waypoint do the following:

1. Find a safe area to do a wide orbit. Set your autopilot to ALT and then make a left or right banking level turn and hold it. Then engage the autopilot and ensure it is holding the turn and you have no elevation conflicts around you.
2. The UTM coordinates will be in the form of 2 letters and 6 numbers.
3. Make sure your STEER PT switch on your AAP Panel is set to FLT PLAN.
4. Set your right MFCD to the CDU repeater function.

****NOTE:** If your CDU is not on the WAYPOINT PAGE, then hit the WP key on the CDU, or FUNC 3 on the UFC. This will bring up the page where you can choose to select WAYPOINT by hitting **OSB 7**. You should now be on the WAYPOINT PAGE and ready to continue.*

5. Hit **OSB 10** to switch from the default L/L (Lat/Long) to UTM.
6. Hit **OSB 9** to select the number presented next to the question mark as your new target waypoint.
7. Using the CDU or the UFC, enter the 2 letters, and 6 numbers without spaces in the scratchpad.
8. Hit **OSB 16** to enter the UTM coordinate into the computer.
9. Verify the number entered is correct.
10. Using the CDU or UFC keypad give your new waypoint a unique name, e.g.: TGT A and hit **OSB 7** to change the name.

11. Now turn your STEER PT dial on the AAP from FLT PLAN to MISSION.
12. Use the UFC STEER rocker or with the HUD as SOI, DMS UP to cycle thru the waypoints until you see the unique name you created for this target.
13. Find your target waypoint symbol on the TAD and then use the steering cues on the HUD to prosecute your attack.

Set a Waypoint as a Steerpoint

As mentioned in the previous section, the CDU database can hold up to 2,050 waypoints, but when a waypoint is selected, it does not provide steering information on the HUD, TAD or HSI. To do so, you must set a selected waypoint as the steerpoint. There can only ever be one steerpoint at a time.

When the AAP PAGE dial is set to WAYPT, you can view current steerpoint data in the lower left corner of the CDU window. However, while you can view steerpoint data, you cannot change the steerpoint from this page.



Figure 354. WAYPT Page

To alter the steerpoint, you must set the AAP PAGE dial to STEER. This will display the steerpoint page and allow you to view more detailed steerpoint data and alter which waypoint is assigned as the steerpoint.

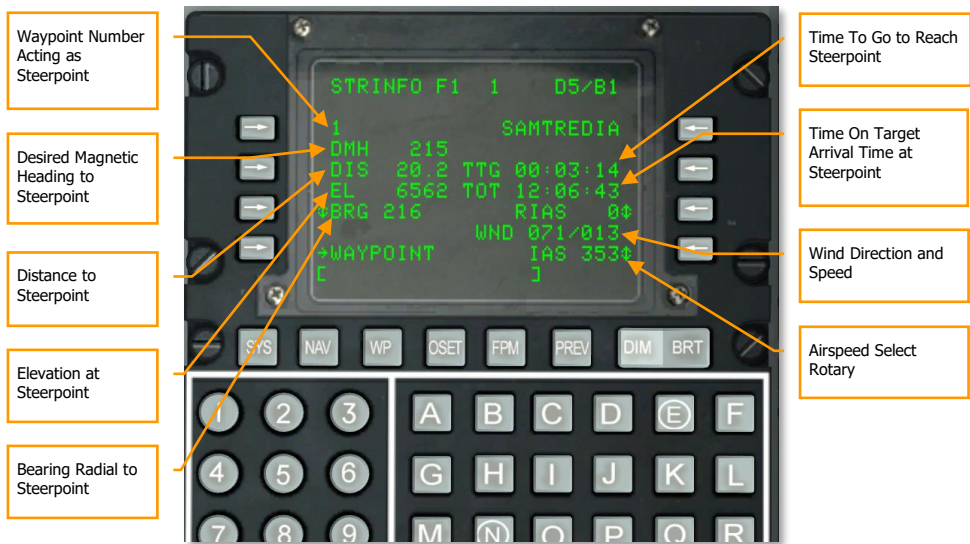

Figure 355. Waypoint Information Page

The default steerpoint is the selected waypoint, but often you want to set the steerpoint independent of current waypoint. To do so, you use the steerpoint page to either enter a new waypoint number or enter a new waypoint name. You may also use the \pm Rocker Switch on the CDU to cycle through flight plan waypoints in the order they are stored in the CDU database and assign one as the steerpoint. After being entered on this page, the selected waypoint will become the steerpoint and you will be provided the following steering information to that location on the HUD and TAD.

With the HUD as SOI, you may also press **DMS Forward and Aft** to cycle through waypoints.

HUD Indication

Along the bottom of the HUD, the Desired Magnetic Heading mark will direct you to the steerpoint. Align the mark in the center of the heading tape.

When the steerpoint is outside the HUD field of view and the steerpoint is not SPI, the tadpole provides heading steering information to the steerpoint. Fly in the direction the tadpole is clamped to on the HUD.

By default, the steerpoint is the SPI.

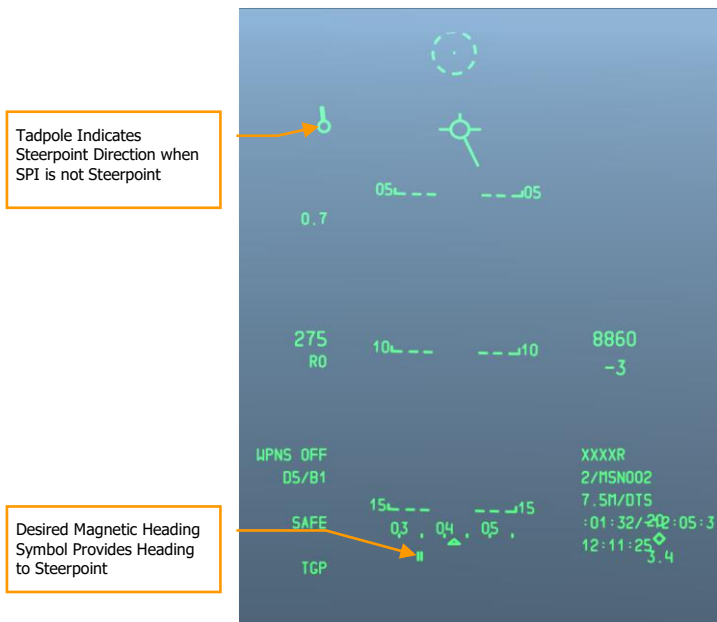

Figure 356. Navigation HUD

Tactical Awareness Display (TAD) Indication

When there is an active steerpoint, it will be displayed on the TAD as a yellow box. Next to the box is displayed the waypoint number that is acting as the steerpoint.



Figure 357. Steerpoint on TAD

Creating / Reassigning an Anchor Point

Also referred to as a “Bullseye”, an anchor point serves as a common geographic reference for a mission amongst friendly forces. In the EGI CDU, you can assign an existing waypoint as the anchor point, or create a new waypoint as described previously. To assign an anchor point, the quickest and easiest way is to start with the AAP PAGE dial set to the WAYPT position. This will then display the current anchor point data in the lower right corner of the page. To set the anchor point, press the LSK next to the ANCHOR PT label.



Anchor Point Data (None set in this Example)

Figure 358. WAYPT Page

When the anchor point page is first displayed and no anchor point has been assigned, it will appear as seen in the image below. To create the anchor point, you will need to enter the waypoint number that you wish to serve as the anchor point and then press the LSK next to the anchor point number field.



Figure 359. Navigation / Anchor Sub-page (blank)

Once you have set the anchor point to a waypoint in the CDU database, the rest of the page data will be filled in.

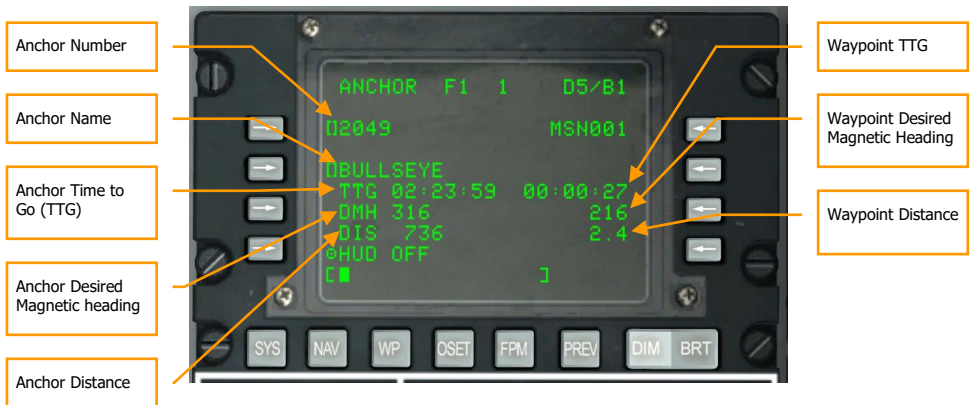

Figure 360. Navigation / Anchor Sub-page

With the anchor point created, you will have indications of its location on both your HUD and your TAD.

- Anchor point Waypoint Name
- Time-to-Go (TTG) to reach Anchor Point
- Desired Magnetic Heading (DMH) to reach Anchor Point
- Distance (DIS) to Anchor Point

HUD Indication

If you have ANCHR selected on the Navigation Mode Select Panel, the Anchor Point Display will appear in the top right corner of the HUD. This display will show the name of the waypoint assigned as the anchor point and the magnetic bearing / ground range distance to that point.

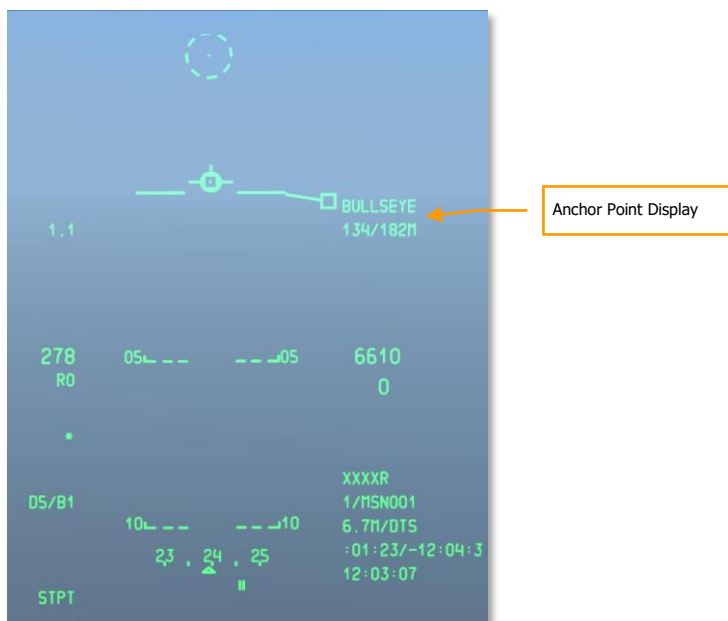

Figure 361. Navigation HUD

Tactical Awareness Display (TAD) Indication

With an anchor point set, an anchor point data block will be displayed in the top left corner of the TAD. Marked "BULL" for Bullseye, the bearing and range to the anchor point is provided.

The anchor point symbol, a dot with two concentric circles, is displayed on the TAD moving map at the anchor point location. Because it is a symbol on the map, it can be hooked with the TAD cursor.



Figure 362. TAD Page with Anchor Data

Setting a Markpoint

In addition to the 2,050 waypoints that can be stored in the CDU database, you may also create markpoints (A-Z). There are three ways you can create a markpoint:

- **Overhead Markpoint.** If you press the MK (markpoint) button on the CDU, a new markpoint will be created at the aircraft location. Each time you press the MK button, a new markpoint will be created in A-Y order (Z is reserved for a weapon release markpoint).
- **Designated Markpoint.** A point on the ground can be set as a markpoint as determined by the line of sight of an aircraft designation source. These sources include the HUD TDC, the Targeting Pod, Maverick Seeker, or TAD Cursor. To create a markpoint in this fashion, place the designation point at the desired location and then perform a **TMS Right Short** press on the control stick. Each TMS right short press will create a new markpoint in order (A-Y).

- **Weapon Event.** Each time a weapon is released, a Z markpoint is created. Each subsequent weapon release replaces the last Z markpoint.



Figure 363. Waypoint Information Page

Once you have created one or more markpoints, you must set the AAP STEER PT dial to the MARK position in order to select and cycle through the markpoints you've created. With MARK selected on the STEER PT dial, you may use the \pm Rocker Switch on the CDU to select the desired markpoint. If you have HUD set as SOI and the AAP set up to MARK, you may also use **DMS Up and Down** to cycle through markpoints. When cycling through markpoints in such a manner, the selected markpoint becomes the steerpoint and SPI by default.

Create a Flight Plan

While we have shown how you can select and display a single waypoint/steerpoint, the Flight Plan function of the EGI CDU allows you to create Flight Plans of up to 40 waypoints. The advantage of the Flight Plan is that it allows you to:

- View all waypoints of interest at once
- Drawing of lines between waypoints on the TAD (route)
- Ability to cycle through each waypoint in the Flight Plan and the selected Flight Plan waypoint becomes the steerpoint
- Create multiple Flight Plans

When flying a mission, displaying the Flight Plan will prove most useful in its ability to display the entire route of the mission at once and the ability to hook any of the waypoints displayed on the TAD.

To create a Flight Plan, you will first need to set the AAP PAGE dial to OTHER and set the AAP STEER PT dial to FLT PLAN.

After setting up the AAP, select the Flight Plan Mode (FPM) Function Select Key on the CDU.

When you open the FPM page, you will see any Flight Plans already created for the mission listed on the left side. They will be listed in order: 01, 02, 03, etc. and may have a name assigned. If there are more than three Flight Plans, you will have to Page Down to the next page.

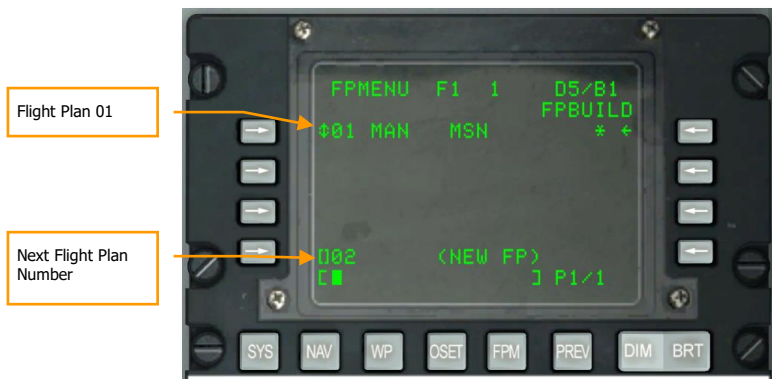

Figure 364. Flight Plan Page

At the bottom of the page is listed the next possible number for a Flight Plan (02 in the case above) and "(NEW FP)" is written in parentheses to the right.

Using the CDU or UFC keypad, type the name you want to give to the next Flight Plan (02 in this case).



Figure 365. Name of New Flight Plan

Once entered, press the lowest left LSK (next to the 02 text) to create the Flight Plan.

The new Flight Plan (02 TEST PLN) will now be displayed on the Flight Plan list.



Figure 366. New Flight Plan Created

If you now select the new Flight Plan by selecting the left LSK for this Flight Plan entry, you can toggle between MAN (manual) and AUTO (automatic). This will regulate if the next waypoint in the Flight Plan is manually or automatically selected after the preceding one is reached.

With the new Flight Plan selected, press the FPBUILD LSK to add waypoints to the Flight Plan.



Figure 367. Add Waypoints to the Flight Plan

To add a waypoint to the opened Flight Plan, enter the number of the waypoint you wish to add to the Flight Plan on the CDU or UFC keypads, and then press an LSK on the left side that does not already have a waypoint assigned. After you have added three waypoints, you will need to press the Page Down rocker on the CDU to go to the next page. Enter all of the waypoints you wish to comprise the Flight Plan.

Note: Waypoint 0 denotes your starting position.

With the Flight Plan created, you will see the entire Flight Plan (waypoints and connecting lines) on the TAD as long as you have FLT PLAN selected on the AAP.



Figure 368. New Flight Plan on TAD

With a Flight Plan active, you can cycle through the waypoints of the Flight Plan using the \pm Rocker Switch on the CDU to set the steerpoint. If the HUD is SOI, you can cycle through the Flight Plan waypoints using **DMS Up and Down**.

Note: The selected waypoint becomes your steerpoint automatically.

Removing Waypoints from a Flight Plan

You can remove waypoints from a flight plan on the FPBUILD page, which is the page where flight plans are created and modified. To get Press the FPM button to get to the FPMENU, then choose the LSK on the right side (under the FPBUILD column) for the flight plan you wish to edit.



Figure 369. Flight Plan Page

On the FPBUILD page, use the PG UP and PG DOWN buttons to navigate to the waypoint you want to delete. Press the left-side LSK adjacent that waypoint to place its number in the scratchpad.

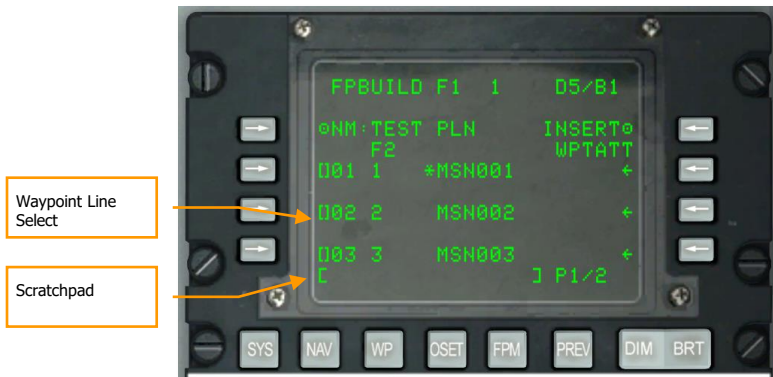

Figure 370. FPBUILD Page

Once the waypoint number is in the scratchpad, press the CLR button on the CDU to remove the waypoint from the flight plan. This does not delete the waypoint, but only removes it from the flight plan.

Setting Desired Time on Target (DTOT)

For each waypoint you can set a Desired Time on Target (DTOT) such that you will be given cues to help you reach a waypoint exactly on time. This can be important when de-conflicting with other forces and coordinating your attacks with your flight. When you view the WAYPOINT page for any waypoint, the DTOT field is on the right side. By using the CDU or UFC keypads you can enter the hour/minute/second (xx-xx-xx) that you want to reach the waypoint and then press the LSK to the right of the DTOT label. This will set the DTOT for that waypoint.



Figure 371. Waypoint Information Page

Once a DTOT is set, you will be provided the required speed you need to fly at to reach the waypoint at the set DTOT.

When the DTOT waypoint is also the steerpoint, you can view the STEER page to view the required airspeed. This is located on the right side of the page and can be displayed according to airspeed type:

- **RIAS.** Required Indicated Air Speed.
- **RTAS.** Required True Air Speed.
- **RGS.** Required Ground Speed.

By adjusting your airspeed to match this value, you should reach the steerpoint at the desired time.



Figure 372. Steerpoint Information

In addition to the required airspeed indication on the CDU, the required airspeed will also be displayed on the HUD, directly below the airspeed numeric.



Figure 373. Navigation HUD with RIAS

TACAN (TCN) Navigation

The Tactical Air Navigation (TACAN) system is a world-wide array of omni-directional beacons with unique frequency codes used primarily by military aircraft. Civilian aircraft use a similar system called VOR's (VHF omni-direction Beacon) on a different frequency range. Many VOR stations are collocated

with a TACAN. These stations broadcast both signals so they can be used by military and/or civilian aircraft. These stations are known as "VORTACS".

TACAN beacons can not only be set on the ground, but they can also be attached to aircraft and even ships (aircraft carriers). TACAN serves as a useful means to quickly navigate to a defined location... often an airfield in this case.



Figure 374. TACAN Panel

TACAN and ILS in the game

To view airfield ILS and TACAN codes, please view the CDU DIVERT page of the desired airfield.

Often KC-135 tankers will also be assigned a TACAN. Please consult the mission briefing for the frequency.

Before starting a TACAN approach though, you will want to do the following:

Select TACAN Station

On the TACAN Operation and Control Panel, dial in the channel of the desired TACAN station (co-located with the airfield you want to land at). With the Channel Select knob, rotate it to select the first digit channel code number. With the XY Channel Select knob, right click to select between selection of the second digit or X or Y.

1. Set the panel Mode Dial accordingly to REC, T/R, A/A REC, or A/A T/R.
 - **REC.** Your TACAN operates in receive mode only and provides bearing, course deviation, and station identification.
 - **T/R.** The TACAN acts in a transceiver mode (send and receive) and provides bearing, range, deviation and station identification. This will be your most common selection.

- **A/A REC.** TACAN operates in Air-to-Air mode and can only receive bearing, course deviation and station identification for a TACAN-equipped aircraft.
- **A/A T/R.** TACAN operates in Air-to-Air transceiver mode and provides bearing, range, deviation, and station identification with a TACAN-equipped aircraft.

In most cases, you will keep the TACAN set to the T/R mode.

2. From the Navigation Mode Select Panel, press the TCN button.

Navigate to Selected TACAN Station

Once a valid TACAN station has been entered on the TACAN panel, the station is within operative range, and TCN is selected on the Navigation Mode Select panel, you will be provided steering information on the HSI to the selected station.

TACAN HSI Indication:



Figure 375. HSI Displaying TACAN Steering

1. **Range Indicator.** When TCN is selected from the Navigation Mode Select Panel, and the selected TACAN station is within operative range, this indicator will display range in nautical miles (000 to 9999) to the station. If the range is not reliable, a warning flag is placed over the indicator.

Note: TACANS are considered reliable for only 130 nm, so the maximum distance between TACANS is generally 260 nm.

2. **Bearing Pointer 1.** The head of this pointer (marked with a "1" on the head), points to the magnetic bearing of the selected TACAN station when TCN is selected from the Navigation Mode Select Panel. To fly the correct heading to reach the selected TACAN station, maneuver the aircraft such that Bearing Pointer 1 is pointed towards the top of the HSI along the lubber line.

ILS Navigation

The landing approach using the Instrumented Landing System (ILS) is generally used under Instrument Flight Rules (IFR) conditions due to night or bad weather. When used, the ILS provides vertical and horizontal steering information to help you fly down the correct glide slope and heading to a safe landing. The ILS consists of an AN/ARN-108 receiver and the ILS control panel on the right console. Steering information is then presented on the ADI and HSI instruments. An ILS results in a straight in approach.

In addition to the instrument indications, the ILS has a localizer audio signal. The ILS provides an audio cue when flying over either the outer or inner landing beacons. You can control the audio levels on the Intercom control panel. When flying over a beacon, the MARKER beacon signal light will also illuminate on the front dash.

Most, but not all runways, allow landings from either direction but will depend on the direction of the wind (you land into the wind). The ILS system should be used for the appropriate landing runway as directed by ATC. Some runways, like Batumi, only have a single landing direction and no beacons.

The ILS operates between 108.1 and 111.95 MHz and has 40 possible channels selected from the ILS control panel.

Select ILS Frequency

1. Turn on the ILS panel by left clicking on the OFF/PWR switch.
2. On the ILS Control Panel, use the left and right dials to set the frequency of the ILS station you wish to receive from. You can view airfield ILS frequencies on the CDU DIVERT page.
3. On the Navigation Mode Select panel, press the ILS button.

Navigate ILS Glide Slope and Localizer

Once a valid ILS station has been entered on the ILS panel, the station is within operative range, and ILS is selected on the Navigation Mode Select Panel, you will be provided steering information on the ADI and HSI to the selected station (much like TACAN).

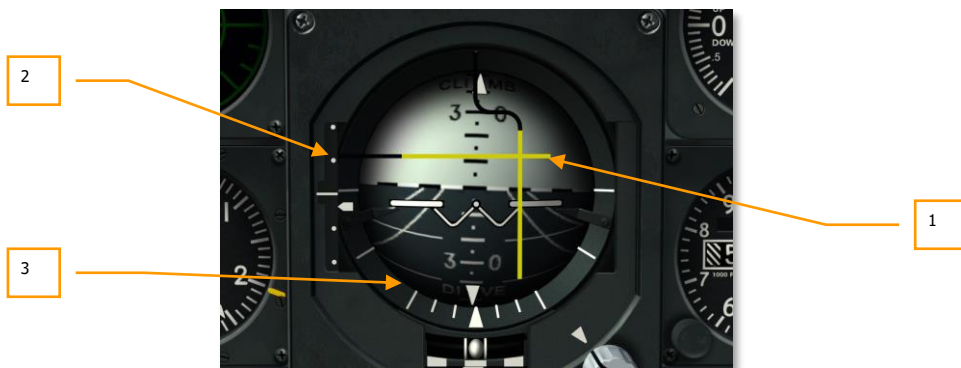
ILS ADI indications:**Figure 376. ADI Displaying ILS Steering**

1. **Localizer and Glide Slope Bars.** When this horizontal bar is centered on the ADI, you are flying down the glide slope projected by the ILS vertical steering component. If the bar is above the center of the ADI, it indicates that you are below glide slope and you need to increase altitude. The vertical localizer bar indicates if you are left or right of runway alignment. If the bar is right of ADI center, fly to the right to center it. For a proper glide slope approach, you want the two bars centered and forming a perfect cross on the ADI (aka "center the bars").
2. **Glide Slope Deviation Scale and Glide Slope Indicator.** Located along the left side of the ADI, this fixed scale and moving caret indicator displays the position of the glide slope in relation to the aircraft. Basically, the caret is the glide slope. If it is high, you are low. For example: if the caret is on the bottom dot, you are above the glide slope. The common terminology would be "you are 2 dots high". Conversely, if the caret is on the first dot above middle you are below the glide slope. The term would be "you are 1 dot low". It is a general rule that if you go more than 1 dot low or more than 2 dots high you go missed approach and try again.
3. **Glide Slope Warning Flag (not visible).** When displayed, this indicates that there is a problem in receiving adequate glide slope signal.

FLIGHT FUNDAMENTALS



FLIGHT FUNDAMENTALS

To be successful in air combat is not an easy task. Fighter pilots of all countries practice for many years to achieve the skills necessary to get the maximum performance out of their aircraft. Though it is impossible to model every aspect of flight training, it is nevertheless important to understand some principles of combat aviation and how to max-perform the aircraft in both air-to-ground and air-to-air engagements. This not only applies to the A-10C, but all combat aircraft.

Aerodynamic Forces

The most fundamental aspect of flight are the four main forces that act on an aircraft:

- **Thrust.** In the A-10C, thrust is generated by the two TF-34 engines. The two engines generate forward thrust by exhausting air at high speed in the opposite direction. The amount of thrust generated is proportional to the mass of the airstream multiplied by the velocity of the airstream. In the A-10C, the thrust the engines are generating is governed by the amount of fuel being supplied to them as set by the engine throttles in the cockpit. The more forward the throttles are, the more fuel is being supplied and the greater the amount of thrust.
- **Lift.** Lift is generated by the wings. This is done as a result of Bernoulli's principle by which the wing moving through the airstream fast enough (using thrust) results in the airstream being faster over the top of the wing than the bottom of the wing. This results in a region of low pressure over the top of the wing that can increase or decrease according to airspeed. As such, the faster you go, the greater the lifting force. Counteracting this is the force of gravity.

Given that air over the wing generates lift, the density of air also dictates lift. Because air density decreases with altitude, the wing generates less lift as altitude increases.

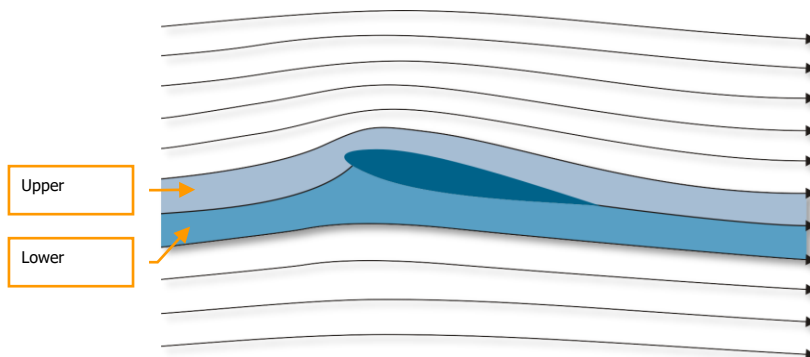

Figure 377. Lifting Surface in Airstream

- **Drag.** Otherwise known as air resistance, drag is the resistance that a body moving through a fluid medium experiences and that counteracts thrust. Drag can be purposely used on aircraft in order to change flight characteristics, and this most often takes the form of surfaces that are introduced into the airstream around the aircraft such as speed brakes, landing gear, and flaps.
- **Gravity.** Gravity is actually a force of acceleration on an object. The Earth exerts this natural force on all objects. Being a constant force, it always acts in the same direction: downward. Thrust creates lift to counteract gravity. In order for an aircraft to take off, enough lift must be created to overcome the force of gravity pushing down on the aircraft.

Air Speeds

The various systems and gauges of the A-10C use a variety of ways to express airspeed. These include:

- **True Airspeed (TAS)** is the actual speed of the aircraft through the air. Under zero wind conditions this is equal to the speed over the ground (Ground Speed). However, when there is wind, an estimation of the wind (wind data as entered in CDU) is used to make an adjusted calculation that computes an estimated ground speed from the True Airspeed. True Airspeed is typically shortened to "TAS". E.g., KTAS = knots true airspeed.
- **Ground Speed (GS)** is the speed of the aircraft relative to the ground. In other words, you can think of it as the speed that the aircraft's shadow passes over the ground beneath you.

- **Indicated Airspeed (IAS)** is an instrumented reading obtained from an airspeed indicator (the pitot tube on the right wing) and is uncorrected for altitude, temperature, atmospheric density, or instrument error. As your altitude increases and air density decreases, IAS will decrease in relation to GS.
- **Calibrated Airspeed (CAS)** is the speed indicated by the pitot tube airspeed indicator after correction for instrument error. At high speeds and altitudes, the calibrated airspeed is further corrected for compressibility errors and becomes Equivalent Airspeed. When flying at sea level, calibrated airspeed is the same as equivalent airspeed and True Airspeed (TAS). If there is no wind, it is also the same as Ground Speed.

Total Velocity Vector (TVV)

The total velocity vector indicator is a common feature on western HUDs; it is also called the Flight Path Marker (FPM). The velocity vector indicates the actual flight direction of the aircraft, which may not correspond with where the nose of the jet is actually pointed. If you place the velocity vector on a point on the ground, eventually, the aircraft will fly directly into that point.

This indicator is an important tool for pilots and can be used for everything from combat maneuvering to landing approaches. Modern, highly maneuverable aircraft like the A-10C can fly at high angle-of-attack (AoA) - when the aircraft flies in one direction, but the longitudinal axis is directed in another.

Angle of Attack (AoA)

As described above, the velocity vector may not coincide with the longitudinal axis of the aircraft. The angle between the velocity vector projection and the aircraft's longitudinal axis is termed angle-of-attack. When the pilot pulls the control stick back, he generally increases the aircraft angle-of-attack. If during a straight and level flight the pilot reduces the engine thrust, the aircraft will start to lose altitude. To continue level flight, one needs to pull back on the stick and thereby increase AoA.

AoA and IAS are connected with an aircraft's lift characteristics. When aircraft AoA is increased up to critical value, aerodynamic lifting force also increases. Increasing indicated airspeed at a constant AoA can also contribute to lifting forces. However, induced airframe drag also increases when AoA and airspeed increase. One has to keep this in mind, or the aircraft could depart controlled flight. For example, the aircraft may depart if the pilot exceeds AoA limits. Limitations are always indicated on the aircraft's AoA indicator gauge.

When aircraft AoA is increased up to a critical value, the airflow becomes disrupted over the wing and the wing ceases to generate lift. Asymmetrical air-mass separation from the left and right wings can induce side movement (yaw) and stall the aircraft. The stall may happen when the pilot exceeds the allowed AoA. It is especially dangerous to get into stalls when in air combat; in a spin and out of control, you're an easy target for the enemy.

When in a spin, the aircraft rotates about its vertical axis and constantly loses altitude. Some types of aircraft may also oscillate in pitch and roll. When in a spin, the pilot has to concentrate all his attention on recovering the aircraft. There are many methods to recover various aircraft types from a spin. As a general rule, one should reduce thrust, deflect rudder pedals in the opposite direction of the spin, and keep the flight stick pushed forward. The control devices should be kept in this position until the aircraft stops spinning and enters a controllable, nose-down pitch angle. After recovering, place the aircraft back into level flight, but be careful not to re-enter a spin. Altitude loss during a spin can reach several hundred meters.

Turn Rate and Radius of Turn

The aerodynamic lift force vector is oblique to the aircraft's velocity vector. As long as the force of gravity is balanced by the lifting force, the aircraft maintains level flight. When the aircraft's bank angle increases, the lift force decreases in the vertical plane.

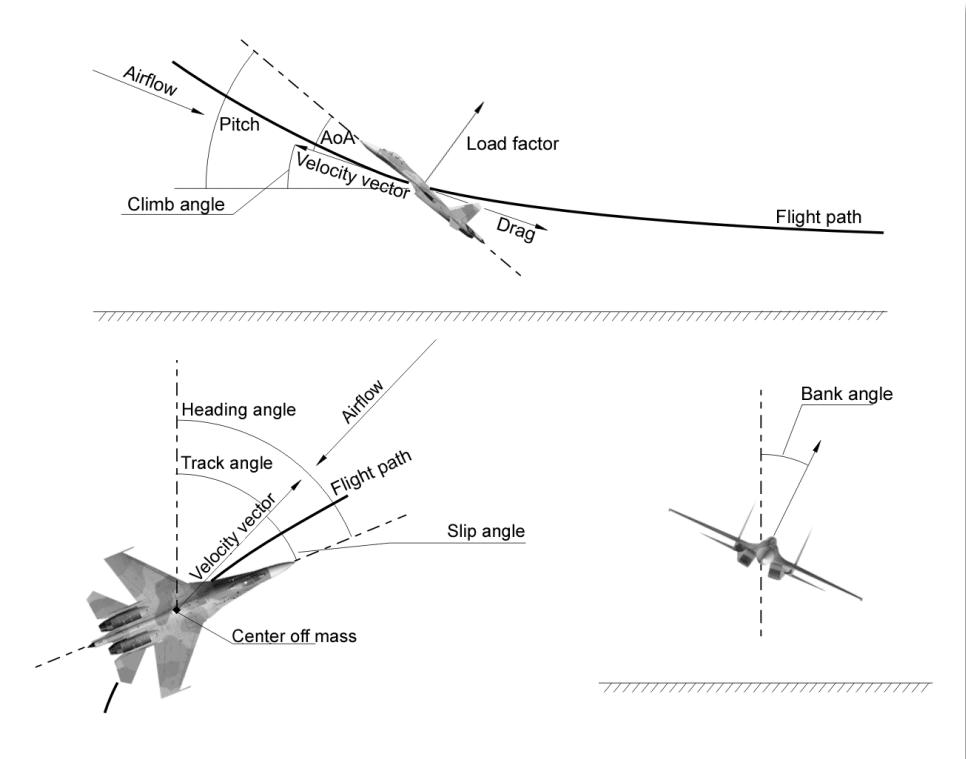

Figure 378: Aircraft aerodynamic forces

The amount of available lift influences the aircraft's maneuvering characteristics. Important indicators of maneuvering capability are maximum turn rate in the horizontal plane and radius of turn. These values depend on the aircraft's indicated air speed, altitude, and its lifting characteristics. Turn rate is measured in degrees per second. The higher the turn rate, the quicker the aircraft can change its flight direction. To max-perform your aircraft, you must distinguish between sustained corner velocity

(no speed loss) and instantaneous corner velocity (with speed loss) turn rates. According to these values, the best aircraft should be characterized by a small turn radius and a high turn-rate over a broad range of altitudes and speeds.

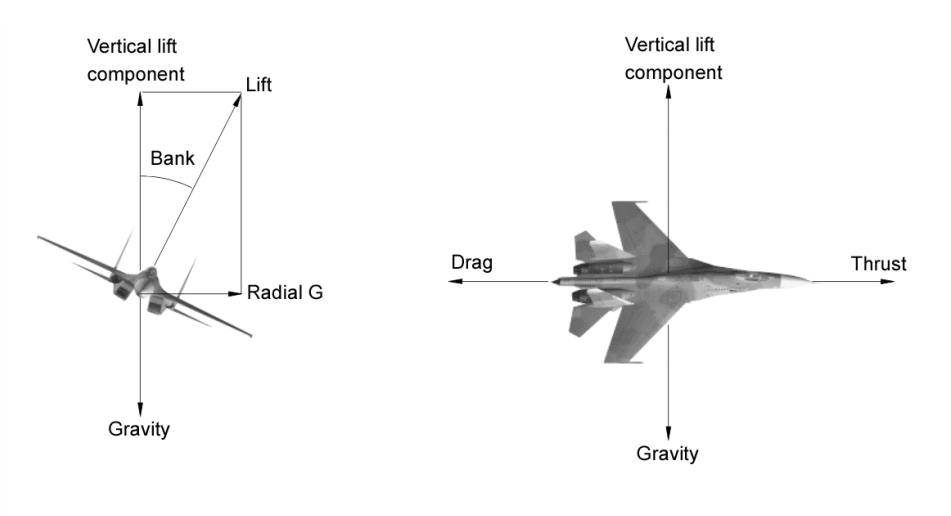

Figure 379: The forces acting on the aircraft

Turn Rate

When G-load increases, turn rate increases and radius of turn decreases. There is an optimal balance at which maximum possible turn rate is achieved with the smallest possible turn radius.

The diagram below illustrates a turn rate vs. KIAS (knots indicated airspeed) performance chart of a modern fighter at afterburner thrust. Airspeed is displayed along the X axis and degrees-per-second is displayed along the Y axis. The "doghouse" looking plot is the aircraft's turn performance along this scale. The other lines represent G-loads and radius of turn. Such a diagram is often called an Energy and Maneuvering (EM) diagram. Though the maximum turn rate occurs at 950 km/h and has a maximum turn rate (18.2 degrees per second), the speed to achieve a smaller turn radius is around 850-900 km/h. For other aircraft, this speed will vary. For typical fighters, corner speeds are in the 600-1000 km/h range.

For example: performing a sustained turn at 900 km/h, the pilot, if necessary, can pull maximum G to increase turn rate to 20° per second for a short time period. This simultaneously decreases turn radius. Doing this, the aircraft will slow down due the high-G excursion. By then entering a sustained G-loading turn, the turn rate will increase up to 22 degrees per second with noticeably decreasing of turn radius. By keeping the aircraft AoA close to maximum you can hold this turn radius and maintain a sustained turn with a constant airspeed of 600 km/h. Using such a maneuver will help either achieve a positional advantage or to break a bandit off your six.

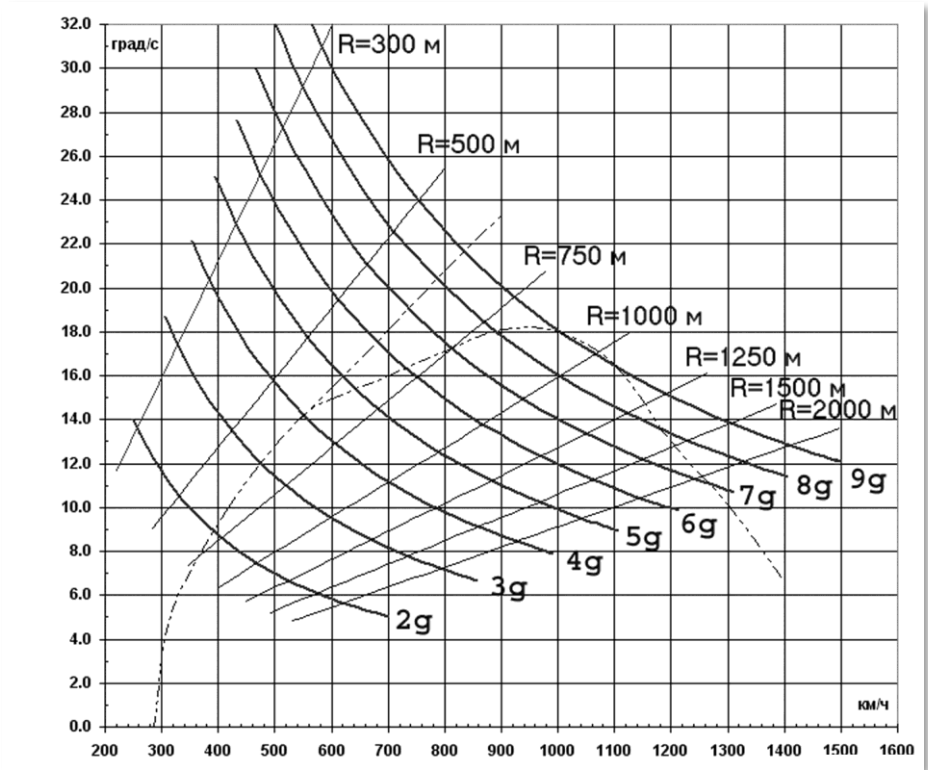

Figure 380: Turn Rate of Modern Fighter

Sustained and Instantaneous Turns

An instantaneous turn is characterized by high turn rates and airspeed loss during maneuvering. The airspeed loss is due to the significant drag generated by the high G and AoA levels. AoA and G loading factors can often reach their maximum, allowable values in a "max-performance", instantaneous turn. Although it will slow your aircraft down, it is the fastest way to get your nose on a target. You may be in an energy-hole after doing so though.

When performing a sustained turn, drag and gravity are balanced by engine thrust. The sustained turn rate is lower than the instantaneous turn rate but is achieved without airspeed loss. In theory, the aircraft can perform a steady turn until it runs out of fuel.

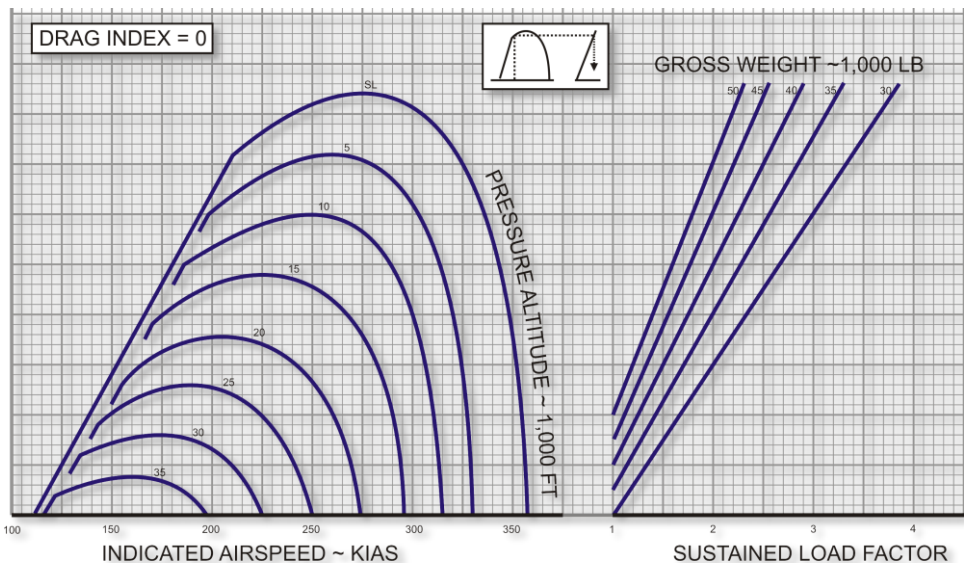

Figure 381: A-10 Sustained Turn Performance, Standard Day, Maximum Thrust

Energy Management

In air combat, the pilot must control the aircraft's energy state. The total energy of an aircraft can be represented as a sum of potential energy and kinetic energy. Potential energy is determined by the

aircraft's altitude; kinetic energy is determined by airspeed. Because thrust developed by the engines is limited, flying at a high AoA will cancel out the thrust. The aircraft will lose energy. To prevent this during combat, the pilot should keep his flight envelope such that he is maneuvering at the aircraft's maximum sustained turn rate and minimizing turn radius simultaneously.

Suppose that energy is equivalent to "money" used to "buy" maneuvers. Suppose there is a constant replenishment (while the aircraft's engines are running). Optimal control requires rational "money" consumption for necessary maneuver purchases. Performing high-G turns causes the aircraft to lose speed and consequently the energy supply (bank) lowers. In this case you can say that the price for cheap turn rate was too high. You now have little money left in the bank and are an easy target for an enemy with a fist full of cash.

Therefore, without a critical need, you should avoid high-G maneuvers that result in speed loss. You should also try to maintain high altitude and not lose it without good reason (this is money in your energy bank). In close combat, try to fly the aircraft at speeds that maximize your sustained turn rate while minimizing your turn radius. If your airspeed reduces significantly, you have to reduce AoA by pushing the stick forward and "unloading" the aircraft. This will allow you to gain speed quickly.

FLIGHT SCHOOL



FLIGHT SCHOOL

General Requirements

The following Flight School chapter is here to provide you with the requirements and our recommendations for flying the A-10C after you have completed the Startup and have a good grasp of navigation and the principles of flight. Flight School will cover each phase of a sortie, from taxi prep to engine shut down, and it assumes that all aircraft systems are working properly (no failures).

It is recommended that the aircraft always be flown with the Stability Augmentation System (SAS) engaged; this provides much greater stability in all flight regimes. Nevertheless, flights can be performed without SAS in case of systems failure or training purposes. The A-10C is still quite controllable without SAS assists.

The primary way to fly the A-10C is by using instrument flying with reference to the attitude direction indicator (ADI) and the head-up display (HUD) indication.

Taxi Preparation and Taxi

Check the instruments for any indications that engines, hydraulics and electrical systems or components are not working properly. Make sure that there are no emergency indications on the caution light panel. All warning systems should indicate normal operations.

1. Check core RPM. Move throttles from IDLE to MAX and back to IDLE within 2 seconds. RPM should not exceed 70%.
2. Stabilize throttles at IDLE for at least 10 seconds.
3. Engage nosewheel steering.
4. Maximum taxi weight is 46,000 lbs.
5. Check engine instruments for nominal indications from Engine Monitoring Instruments Panel.
6. Set Flaps for takeoff (MVR 7 degrees).
7. Ensure speedbrakes are closed.
8. Takeoff trim check. Press T/O TRIM button on the SAS Panel.

9. Verify that both EGI and TCN lights on Navigation Mode Select Panel are lit.
10. Enable oxygen flow to NORMAL on Environment System Panel.
11. Set exterior lights from Lighting Panel:
 - 11.1. **Taxi:** Strobe is OFF, and Nav Lights set to Dim Flash
 - 11.2. **Flight:** Strobe is ON and Navigation Lights set to STEADY
 - 11.3. **Night Taxi:** Strobe is OFF, Navigation Lights set to FLASH, and Taxi Light ON as required
12. Move throttles forward slowly as required to start forward movement.
13. Use the rudder pedals to steer the aircraft left and right; do not use differential braking to steer.
14. Taxi speed should be between 15 and 25 knots.
15. While taxiing, the canopy should never be opened or closed while turning.
16. Use the toe brakes to slow and stop the aircraft.

Runway Lineup Checks

Once lined up for takeoff on the directed runway, you will need to perform the final checks:

1. Final check of flight instruments for any abnormalities.
2. Ensure anti-skid switch is set to ANTI-SKID on the Landing Gear and Flap Control Panel.
3. Enable Pitot Heat from the Environment System Panel.
4. Hold down the brakes and increase throttles to 90% core RPM to run up engines.
5. Check engine instruments for proper indications on the Engine Monitoring Instruments Panel.
6. Make sure all warning and caution lights are off on the Caution Light Panel.

Normal Takeoff

1. If an aircraft is taking off ahead of you, wait 10 seconds after the aircraft starts its takeoff roll before you start yours. If the aircraft is loaded with live ordnance, wait 20 seconds.
2. Release the brakes and advance throttles to MAX (full forward).
3. Monitor engine instruments on the Engine Monitoring Instruments Panel.

4. During takeoff roll, maintain directional control using nosewheel steering until flight controls become effective. Disengage nosewheel steering at 70 KIAS.
5. At approximately 10 knots prior to takeoff speed, pull back on the control stick and establish a pitch angle of 10 degrees. Rotation is generally around 135 knots with a combat load.
6. With pitch established at 10 degrees, let the aircraft fly itself off the runway. Do not yank back on the stick to get the aircraft airborne!

Crosswind Takeoff

When taking off in a crosswind, the aircraft will want to weather-vane into the wind (turn into the wind). This will have the result of raising the upwind wing. To counteract, you want to use a slight amount of aileron into the wind direction. This will help keeping the wing level. You will also want to use a little rudder input to keep a straight takeoff roll down the center of the runway.

When reaching 70 knots, nosewheel steering should be disengaged if the crosswind is greater than 20 knots. After nosewheel steering is disengaged, use the rudders to maintain takeoff roll direction.

During rotation, be careful to smoothly blend rudder input to establish a proper crab angle into the wind. With a proper crab angle, the Total Velocity Vector (TVV) should be aligned down the runway when becoming airborne.

Climb Out

After becoming airborne at a positive rate, maintain takeoff pitch of 10 degrees during acceleration to climb speed. Once established in the climb:

1. Retract the landing gear from the Landing Gear and Flap Control Panel.
2. Retract flaps to the UP 0 degrees position.
3. Adjust pitch and engine power to maintain climb to specified speed and altitude.
4. Check oxygen regulator is on when passing over 13,000 feet from the Environment System Panel.

Basic Maneuvers

When flying the A-10C, you will need to understand the basics of flying the aircraft from one point to the next. This comes down to four basic aspects of flying the aircraft:

1. Adjust your airspeed to reach your destination and not stall the aircraft
2. Changing the altitude of the aircraft from takeoff, to cruise, to landing
3. Changing the heading (flight direction) of the aircraft to reach your destination
4. Trimming the aircraft

Using a combination of these four basic points allows you to perform much more complex maneuvers.

Note: When maneuvering the aircraft with the control stick (pitch and roll), it is important to remember to not over-control the aircraft. Although there will be exceptions when you need to, most often just gentle movements of the stick (not rapidly to its limits) are required to maneuver the aircraft. Large, rapid stick movements can lead to rapid high angle of attack onset, high G-loading on the aircraft, and rapid loss of speed. Use a light touch and do not over-control!

If you start to hear the steady or chopped angle of attack tone, decrease the pitch input until the tone is silenced.

Changing Airspeed

After takeoff, your airspeed will be in the area of 135 knots. While this is sufficient for flight with full flaps, you will not reach your destination very quickly and you will not be very maneuverable. As such, you will want to increase your speed. To increase and decrease your airspeed, you have several methods available to you:

- **Aircraft engine power.** The more you advance your throttles, the more thrust the engines will produce. Generally, you will monitor engine power as a function of fan speed and Core RPM on the Engine Monitoring Instruments Panel. Normal maximum power is 98% for Core RPM, 82% for Fan RPM at takeoff.
- **Aircraft pitch angle and pitch rate.** Generally, when pointing the nose up in positive pitch, the aircraft will slow down. When pointing the nose down in negative pitch, the aircraft will speed up. The more rapid you make a pitch change can also affect speed. Whether it is a pitch change in the horizontal plane or in the vertical plane, the more rapid and greater the pitch change, the greater the G-loading on the aircraft. The greater the G-loading, the greater the negative effect on your speed.
- **Speedbrakes.** By opening the speedbrakes you can slow down the aircraft due to drag.

- **Landing Gear.** The landing gear can also slow you down due to increased drag, but they should only be lowered when below 250 knots. Landing gear is controlled from the Landing Gear and Flap Control Panel.
- **Flaps.** Lowering the flaps causes drag and this too will slow you down. The more they are extended, the greater the induced drag and more it will reduce your airspeed. You can monitor flap position from the Landing Gear and Flap Control Panel. Note that at higher speeds, the flaps will automatically retract.

To view airspeed, monitor the airspeed numeric on the HUD or the airspeed gauge on the front dash.



Figure 382. Front Dash

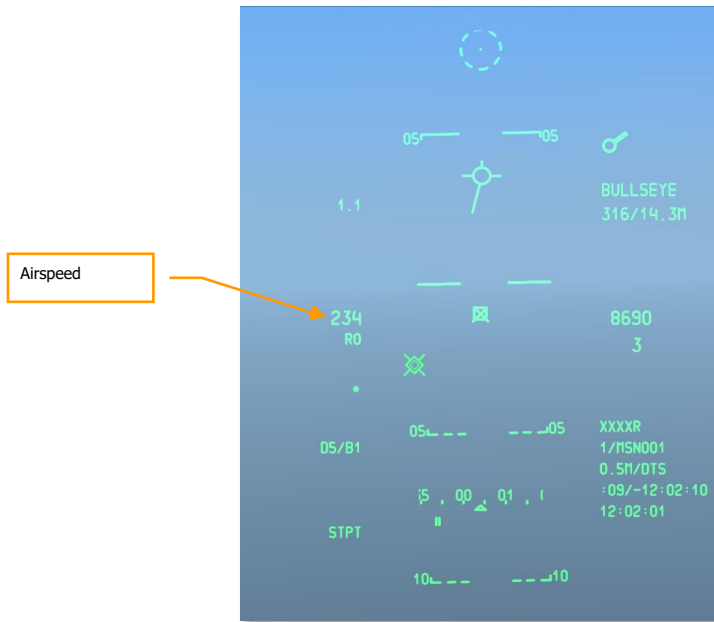

Figure 383. Navigation HUD

Changing Altitude

To increase or decrease your altitude, you will do so by changing the pitch of the aircraft.

To increase altitude, pull back on the stick to raise the nose of the aircraft. As you increase pitch though, you will start to lose airspeed. If the aircraft starts to stall, you will need to lower the nose or increase power.

To decrease altitude, push the stick forward and lower the nose of the aircraft below the horizon. As you pitch down though, you will increase your airspeed. To maintain current airspeed, you can reduce throttles or open the speedbrakes.

To monitor altitude, view the barometric and radar altimeters on the HUD and the altimeter gauge on the front dash.

You can also view your positive or negative vertical velocity with the Vertical Velocity Indicator on the front dash.

To maintain constant altitude, maneuver the aircraft in pitch to keep the Total Velocity Vector (TVV) on the Horizon line. In such a situation, the VVI will indicate zero. When the TVV is above the Horizon line and you have sufficient speed, you will increase altitude. When the TVV is below the Horizon line, you will always decrease altitude.

Note that if you do not have sufficient airspeed, your aircraft will lose altitude regardless of pitch. In such a stall situation, you risk departing the aircraft from controlled flight.

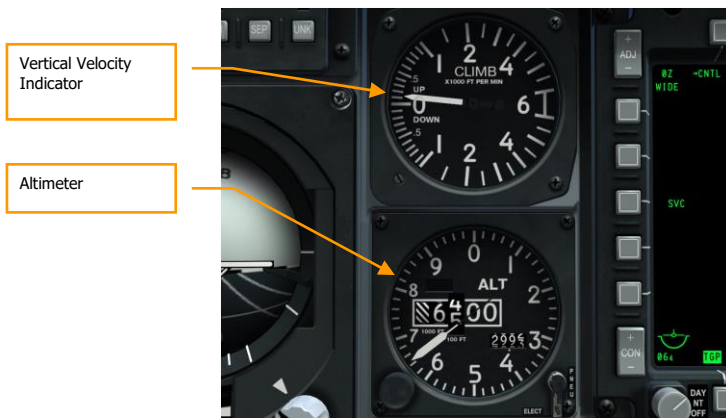

Figure 384: VVI and Altimeter

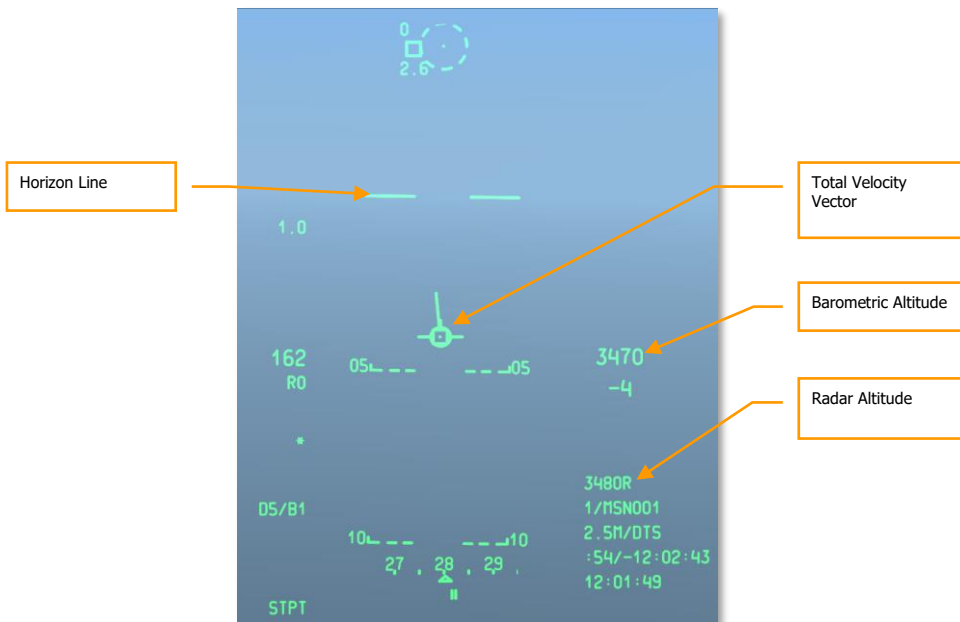

Figure 385. Navigation HUD

Changing Heading

To turn the aircraft in the horizontal plane to a new heading, you need to move the stick to the right or left and gently pull back. By rolling the aircraft in the direction you wish to point the aircraft and then pulling back on the stick, the aircraft will pull its nose in that direction (you can think of it as a horizontal loop). When you have reached the new, desired heading, center the stick and roll the aircraft back in the opposite direction to level the wings.

Note the following:

- The greater the roll angle will equate to the greater amount you must pull back on the stick to keep from losing altitude (TVV on the HUD horizon line).

- The more you pull back on the stick to make a turn will generate a higher G-loading on the aircraft and slow you down. If you lose too much speed, the aircraft may become uncontrollable.

To keep from changing altitude during a turn, keep the TVV on the Horizon Line and adjust pitch and roll input on the control stick to do so.

You can view your current heading on the bottom of the HUD. The heading scale shows your current magnetic heading indicated by the central caret. The desired magnetic heading indicator shows the heading to your steerpoint. If you turn the aircraft to align the heading caret with the desired magnetic heading indicator, you will be flying to your steerpoint.

You can also view your current heading on the Horizontal Situation Indicator (HSI). The indicated heading at the top of instrument that is aligned with the top of the lubber line indicates your current heading.



Figure 386: Horizontal Situation Indicator

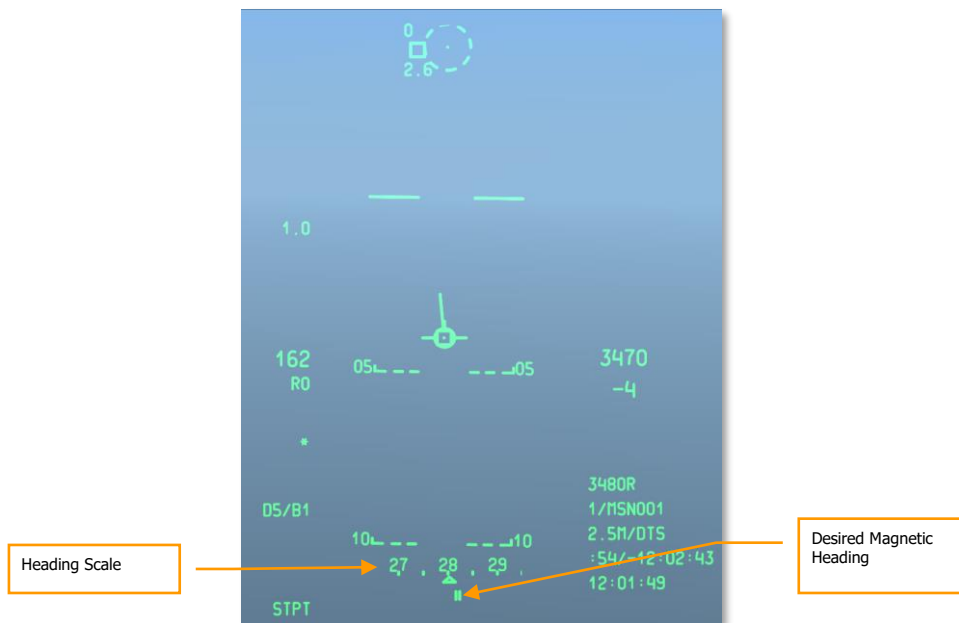

Figure 387. Navigation HUD

Trimming the Aircraft

Unlike some modern aircraft that offer automatic trimming capability, the A-10 series relies on manual trimming. The trim switch is used to move the control stick to a new "neutral" position. For example: if the nose wants to raise, you can input some nose down trim that will move the stick forward to a new neutral position. This relieves you from maintaining continuous pressure forward on the stick to maintain level flight when out of trim.

When out of trim, you will notice the aircraft wanting to pitch, bank or yaw (pitch being the most common). The most common need for trim is when changing airspeeds. As the aircraft changes speed, the nose will want to raise and fall. You will be trimming-to-speed during different flight phases such as takeoff, cruise, and landing.

The trim tabs on the control surfaces are electronically powered. In fact, with dual-hydraulic system loss, you will fly the aircraft in roll using the aileron trim tabs as a function of the Manual Reversion System.

Setting trim, with practice, will soon feel like second nature!

Aerial Refueling (Quick Flow)

For combat missions in particular, you may have an aerial refueling requirement. Although the A-10 can carry up to three TK600 external fuel tanks, these tanks are not combat-survivable and are never used on combat missions.

The A-10C is equipped with a nose-mounted refueling receptacle that is fed from a boom-equipped tanker.

Preparation

When nearing the tanker location, you will want to place the flight in Echelon formation.

1. Radio contact tanker and inform of intent for refueling.
2. At least one engine must be operating at 85% RPM.
3. Safe the aircraft from AHCP:
4. Master Arm switch to SAFE
5. GUN/PAC switch to SAFE
6. LASER switch to SAFE
7. Safe aircraft from DSMS:
8. Set Maverick EO power to OFF
9. Set up your Fuel System panel:
10. If you have a leak in any of the four internal fuel tanks, you should pull out the Fill Disable button for that tank. This will prevent the damaged fuel tank from being filled.
11. Tank Gate switch to the closed position.
12. Open the refueling receptacle slipway. Upon doing so, the READY light will illuminate.
13. Fly the formation to the pre-contact position:
 - Wingman 2 takes observational position off flight lead wing (On Deck position).
 - Second element takes observational position right of the On Deck position.
 - Refueling order is FL → 2 → 3 → 4

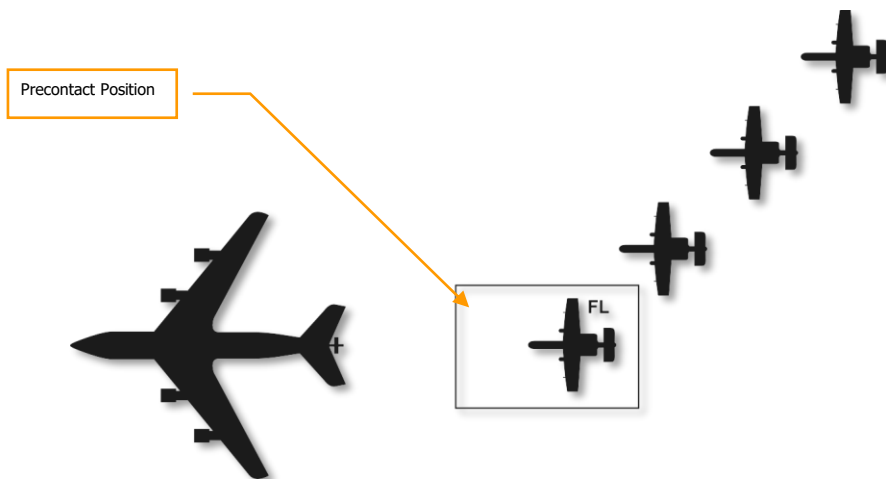

Figure 388. Aerial Refueling, Start

Pre-Contact

Upon reaching the pre-contact position 1 nm behind the tanker in trail, you need to stabilize your position and establish a zero rate of closure on the tanker.

1. Check you have sufficient fuel to complete process.
2. Set IFF to Standby (STBY)
3. Set CMSP to Standby (STBY)
4. If at night or foul weather, enable the exterior lights from the Exterior Lighting Dial.
5. If you cannot establish pre-contact, you must break away or risk an overrun.
6. Request contact from tanker.

If given permission, move forward and follow directions of the boom operator. Close to the tanker at 2-3 knots until reaching the contact position. Align the boom with the center longitudinal axis of the aircraft. Make constant reference between the boom and the tanker fuselage and avoid "chasing" the boom.

Contact

Once established in the contact position, the boom operator will "fly" the boom into the receptacle.

Once boom contact is made, confirm the LATCHED light on the canopy bow is illuminated. The READY light should extinguish.

Once both you and the tanker acknowledge contact, the refueling will start.

For successive contacts, you must cycle the aerial refuel system by pressing the refuel/reset button (Nosewheel Steering button) or closing and opening the slipway door.

Disconnect

When the tanks are full, line pressure will automatically disconnect refueling. When this happens, the DISCONNECT light will illuminate. To manually disconnect, you can also press the nosewheel steering button on the control stick.

1. Close the receptacle slipway door.
2. Decrease power and drop back and down behind the tanker.
3. Once you have pulled out of the contact position, you will establish yourself off the left wing of the tanker.

Following your departure from the contact position, number 2 will move into the contact position and number 3 will move into the On Deck position. This pattern will continue until all aircraft are refueled. As each aircraft is refueled, they will reform with you off the tanker's left wing.

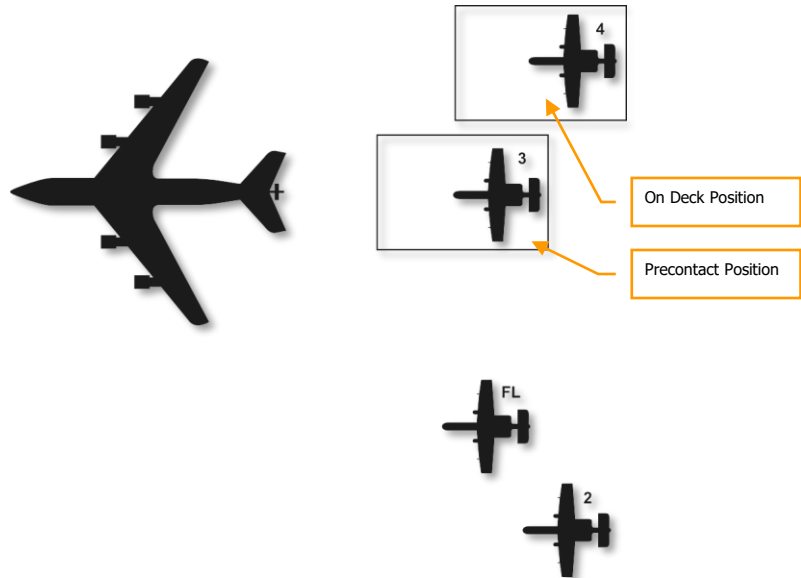

Figure 389. Aerial Refueling, Mid

Landing Preparation

Prior to landing the aircraft, you should set up the aircraft in preparation:

1. Check that altimeter data is accurate
2. Set Anti-skid switch to ANTI-SKID
3. Turn on landing lights
4. Check fuel quantity to confirm you have enough for planned approach
5. Set HUD to Indicated Air Speed (IAS)
6. Remove NVGs if you are already wearing them

Landing Traffic Pattern

After completing a sortie, perhaps the most challenging part may still await you... the landing. Depending on the time of day, weather conditions, and the amount of air traffic in the area, there are one of three landing methods you may need to use.

- **TACAN Approach.** This approach is based on navigating to the selected Tactical Air Navigation (TACAN) station located on or near the airfield prior to landing.
- **ILS Approach.** This approach is based on flight direction from the Instrument Landing System (ILS).
- **GCA Approach.** A radar approach is based on directions provided by the Air Traffic Control (ATC) center.

TACAN Approach

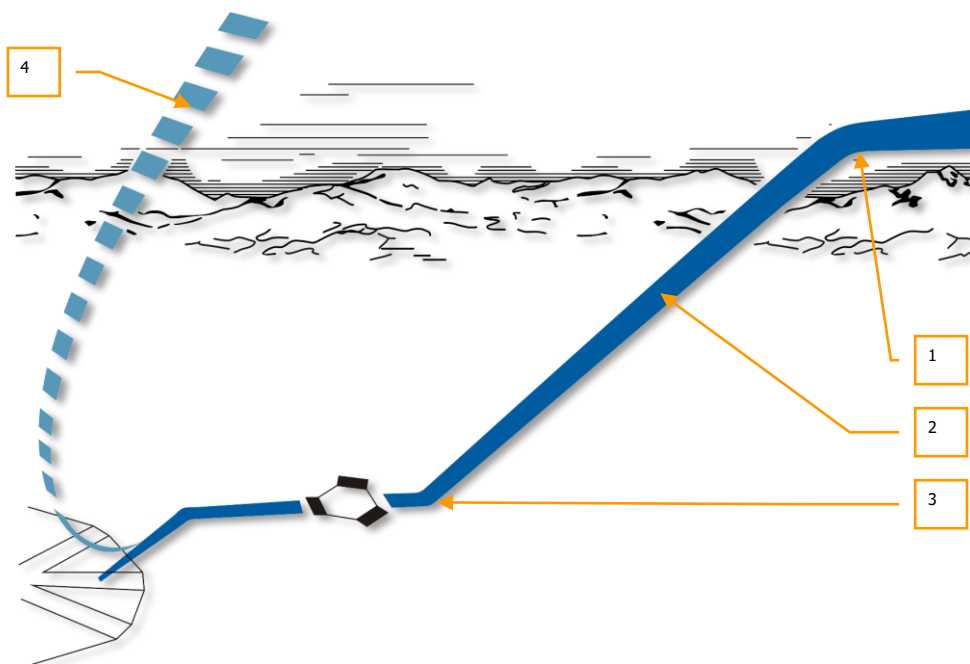

Figure 390. TACAN Landing Pattern

1. **Holding Pattern.** You may be instructed by ATC to maintain a holding orbit at an assigned location and at the assigned altitude to de-conflict with other flights. Maintain airspeed between 200 and 350 KIAS. You will maintain this holding pattern until instructed by ATC to initiate your final approach fix.
2. **Penetration Descent.** Once cleared to penetrate to the TACAN station, descend to the TACAN station location at a rate of approximately 1,200 to 1,500 ft/min on the "VVI" indicator -300 feet for every mile traveled and maintain 200 – 250 KIAS. You may need to reduce throttle and use speed brakes to stay on-speed. Note that the TACAN station is most often located on the runway and your TACAN steering, and distance indications will also be in regard to the selected airfield. As you descend to the level-off point, you will need to monitor your descent to make sure it is possible to reach our level-off point of 400 ft in a safe manner and not at a very steep dive angle.
3. **Level Off.** Start to level off at 400 ft and fly a flat approach if you are performing a straight in approach or 600 ft if performing a circling approach. When reaching this point, your airspeed should be reduced to 150 KIAS at a minimum. You now need to put the aircraft into landing configuration (see later in this chapter). Visually spot the runway and land (straight in or circling).
4. **Missed Approach.** If during the final approach it appears you cannot safely land by the time you reach the Missed Approach Point (MAP), you must abort the approach, close the speed brakes, raise the landing gear, set flaps to UP, and increase airspeed to 200 – 220 KIAS.

ILS Approach

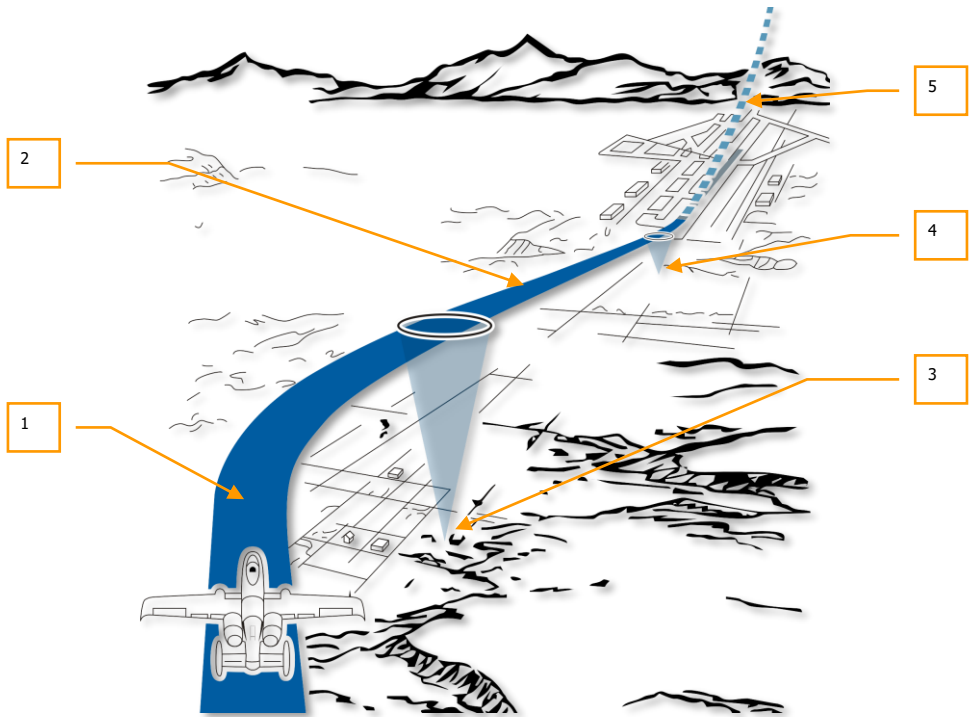

Figure 391. ILS Landing Pattern

1. **ILS Approach.** An ILS approach generally starts at 2,000 ft AGL with flaps UP and airspeed around 150 KIAS. With the ILS panel set to the desired airfield, the ILS needles on the ADI will provide localizer and glide slope steering. Maneuver the aircraft to center the bars and maintain CDI course steering. If on correct glide slope, the angle of attack indexer lights should show the green donut.
2. **Final Approach.** On final approach and over the outer marker beacon (indicated by the Marker light and audio indication), open speed brakes to 40%, extend the landing gear, lower flaps to the down (DN) setting and maintain landing glide slope angle of attack as indicated on ADI and AoA indexer lights.

3. **Outer ILS Marker.** The outer marker beacon, when the ILS panel is set to the desired airfield, will be indicated by the Marker Light and audio marker tone when flown over.
4. **Inner ILS Marker.** Once over the inner marker beacon, the Marker Light will illuminate again and the marker beacon audio tone will sound. The inner beacon is shortly before the runway threshold and a standard landing should then be performed.
5. **Missed Approach.** If during the final approach it appears you cannot safely land by the time you reach the Missed Approach Point (MAP), you must abort the approach, close the speed brakes, raise the landing gear, set flaps to UP, and increase airspeed to 200 – 220 KIAS.

Ground Control Approach (GCA)

Prior to approach, contact ATC and request approach and the ATC will provide you with heading, altitude and airspeed data at which to reach the pattern entry point. From there you will fly the following legs in communication with ATC. This could either be a straight in or circling approach to landing.

Circling Landing Approach

Depending on runway availability and wind direction, there are two general circular landing approach patterns:

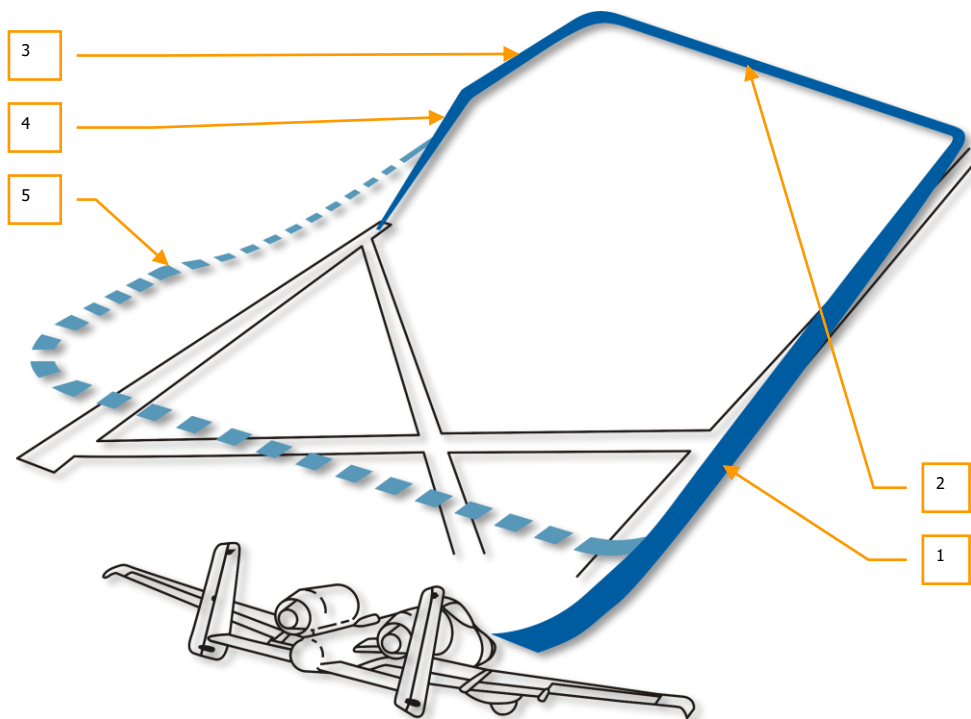

Figure 392. Circling 180° Landing Approach

1. **Downwind Leg.** After reaching the pattern entry point according to ATC instruction, you fly the downwind leg of the pattern starting at 2,000 feet (offset from landing runway) with the gear up and flaps up and at 250 KIAS. You will gradually descend at a rate of -300 feet for every mile traveled. When the end of the runway is 45° behind you, you will initiate a 90° heading change with a 60° bank angle in the direction of the runway. This will place you on the Base Leg at an altitude of 1,500 feet. If there are other aircraft in the flight, each aircraft will initiate the break into the base leg at 5 second intervals.
2. **Base Leg.** Starting from 1,500 feet, descend at a rate of -300 feet for every mile traveled and reduce speed to 150 KIAS. When the runway threshold is nearly off the wing and you are at the Perch Point, perform a 90° heading change towards the runway at a 60° bank angle to enter final approach at around 300 feet. After rolling in on final, you should be at 300 ft and one mile from the runway.

3. **Before Glide Path Final Approach.** Maintain descent rate towards the runway at angle of attack on speed (AoA indexer light showing a green donut), extend brakes to 40%, lower the landing gear, and lower the flaps to DN. Maintain on-speed angle of attack.
4. **On Glide Path Final Approach.** Maintain glide slope at -500 FPM on the VVI and a green donut on the AoA indexer lights.
5. **Missed Approach.** If the approach must be aborted, close the speed brakes, raise the landing gear, set flaps to UP, and increase airspeed to 200 – 220 KIAS.

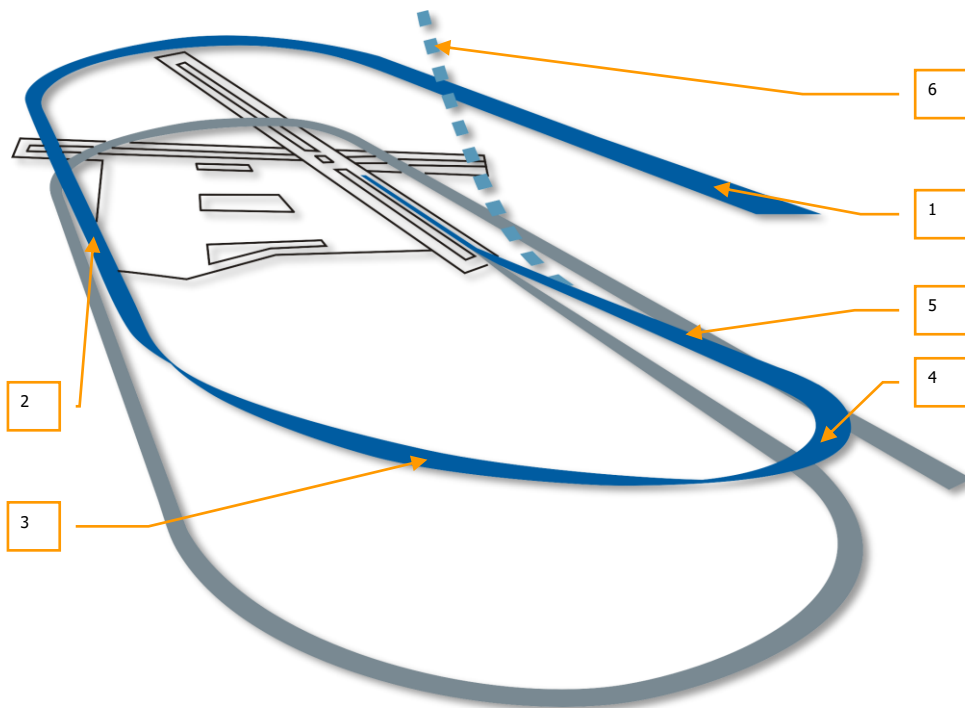

Figure 393. Circling 360° Landing Approach

1. **Initial Approach.** Enter and maintain the pattern at 2,000 feet between 250 and 300 KIAS.
2. **Downwind Leg.** After reaching the pattern entry point according to ATC instruction, you fly the downwind leg of the pattern starting at 2,000 feet (over the landing runway) with the gear up and flaps up and at a speed between 200 and 250 KIAS. You will gradually descend at a rate of

-300 feet for every mile traveled. When the end of the runway is 45° behind you, you will initiate a 90° heading change with a 60° bank angle in the direction of the runway. This will place you on the Base Leg at an altitude of 1,500 feet.

3. **Base Leg.** Starting from 1,500 feet, descend at a rate of -300 feet for every mile traveled and reduce speed to 150 KIAS. When the runway threshold is nearly off the wing, perform a 90° heading change towards the runway at a 60° bank angle to enter final approach at around 300 feet.
4. **Before Glide Path Final Approach.** Maintain descent rate towards the runway at angle of attack on speed, extend brakes to 40%, lower the landing gear, and lower the flaps to DN. Maintain on-speed angle of attack.
5. **On Glide Path Final Approach.** Maintain glide slope at -500 FPM on the VVI.
6. **Missed Approach.** If the approach must be aborted, close the speed brakes, raise the landing gear, set flaps to UP, and increase airspeed to 200 – 220 KIAS.

Straight-In Landing Approach

From the landing approach point as directed by GCA, TACAN or ILS, begin an on-glide slope descent directly to the runway to arrive one mile from the runway threshold at 300 ft AGL.

Landing

1. After you have entered final approach from either a straight in approach or circling approach, you need to land the aircraft. It is important that you maintain on-speed angle of attack (indicated by AoA indexer), landing gear is down, speedbrakes open to 40%, and flaps are set to the DN position.

You can also use the Total Velocity Vector (TVV) symbol on the HUD to best estimate your touchdown position.

2. Keep the airbrakes at 40% open. This will allow you a way to access power quickly by retracting them.
3. Keep the angle of attack index on the canopy frame centered on the blue "donut". This will keep you on the correct angle of attack approach.
4. Shortly before main wheel touchdown, gently pitch back on the stick to flare the aircraft nose up and allow the main gear wheels to touch down gently first.

5. If the aircraft center of gravity is forward of center, note that more aft stick may be required to maintain proper attitude and the stick will be less responsive in pitch.
6. Once the main tires have touched down, retard the throttles to IDLE and use the rudder pedals to keep you aligned down the runway during roll out.
7. Allow the nose wheel to drop down gently and then use nose wheel steering to maintain alignment down the runway.

Crosswind Landing

When landing in a crosswind, you should crab the aircraft into the wind and lower the wing in that direction. Carefully combine these to keep the flight path of the aircraft aligned down the runway. Use gentle rudder input to maintain the crab angle.

Shortly before flaring the aircraft to land, use the rudders to yaw the aircraft to align with the runway and increase bank angle into the wind to maintain flight path.

When touching down, a slight crab angle is acceptable as long as you quickly correct with rudder to maintain alignment down the runway. Do not exceed 10° of crab angle at touchdown or it could lead to landing gear damage.

After touchdown, the aircraft will want to weathervane into the wind, so you must compensate with rudder use. Once your speed falls below 70 KIAS, use nose wheel steering.

Aircraft Shut Down

After clearing the runway and parking the aircraft, you can then shut down the aircraft doing the following:

1. Close the speed brakes
2. Set wheel brakes
3. Set Anti-Skid switch to OFF
4. Open canopy as desired
5. Turn TACAN panel OFF
6. Turn ILS panel OFF
7. Set IFFCC switch on AHCP to OFF
8. Set CICU switch on AHCP to OFF
9. Turn off left and right MFCDs
10. Turn off Landing Gear / Taxi lights

11. Set CMSP panel Mode dial to OFF
12. Set Pitot Tube heating switch to OFF
13. Set Position lights to Bright/Flash
14. Turn off Anti-collision lights
15. Retract flaps to UP
16. Set EGI switch on AAP to OFF
17. Set CDU switch on AAP to OFF
18. Turn TISL panel OFF if needed
19. After 5 minutes at IDLE, set left throttle to OFF and confirm core RPM reaches 5% and ITT is below 200c
20. After 5 minutes at IDLE, set right throttle to OFF and confirm core RPM reaches 5% and ITT is below 200c
21. Set Inverter switch to OFF
22. Set Battery switch of OFF
23. Turn off all radios

COMBAT EMPLOYMENT



COMBAT EMPLOYMENT

Target Area Ingress Preparations

Prior to reaching the target area and conducting your attack, you will want to configure several aircraft systems ahead of time so that you can most efficiently communicate and set up your attack. When at a minimum of 40 nm from the target, you will want to take the following steps:

Set Up Countermeasures

Assuming enemy units will be shooting at you, it's best to set up your countermeasure system ahead of time. This will allow you to quickly select the needed countermeasure program and focus on the attack and less on setting up your defenses.



Figure 394. CMSP Panel

From the Countermeasure Signal Processor (CMSP) panel:

1. Select the Mode of choice from the Mode Select Dial. Depending on the level of control and consent you wish to have, you can select between the three options of:
 - **MAN.** Manual mode requires you to manually select the Dispense program, activate it, and select and initiate the ECM program.

- **SEMI.** Semiautomatic mode will select the best Dispense program, but it will be up to you to start and stop the program. In the same manner, SEMI mode will select the best ECM program according to the detected threat, but it will be up to you to activate and deactivate it.
- **AUTO.** Automatic mode will automatically select the best Dispense and ECM programs and activate them.

Dispense Programs. When creating dispense programs, you probably want to have at least six general types:

- Mix of chaff and flares released in a fast interval to defend against an incoming missile of unknown type (infrared or radar guided).
 - Mix of chaff and flares released at a low interval over a long period of time. When entering a target area, you may wish to activate such a program to act as a preventative measure against both infrared and radar guided air defense systems.
 - Chaff-only released at a fast interval. Use this program to defend against an incoming radar guided air defense system.
 - Chaff-only released at a low interval over a long period. When entering a target area, you may wish to activate such a program to act as a preventative measure against radar guided air defense systems.
 - Flares-only released at a fast interval. Use this program to defend against an incoming infrared guided missile system.
 - Flares-only released at a low interval over a long period. When entering a target area, you may wish to activate such a program to act as a preventative measure against infrared guided missile systems.
2. Enable countermeasure systems by moving the DISP, RWR, JMR, and MWS System Select Switches to the ON position.

When in MAN or SEMI Modes, you can cycle DISP programs and start / stop the programs with the following HOTAS commands:

- **CMS Forward Short.** Start selected program.
- **CMS Aft Short.** Cease active program.
- **CMS Left Short.** Select previous DISP program.
- **CMS Right Short.** Select next DISP program.

Turn Off Exterior Lights

The hostile artificial intelligence has a better chance of visually sighting you if you have external lights on, so you will want to extinguish them when you ingress into the target area.

The fastest way to do this is to set the Master Exterior light switch to the center position. This will turn off the position lights, formation lights, nose floodlights, nacelle floodlights, and anti-collision lights.

Armament HUD Control Panel (AHCP) Set Up

From the AHCP, you will want to enable the combat systems with enough time to spot any problem areas before rolling in on your target.



Figure 395. Armament HUD Control Panel

1. Set the Master Arm switch to the ARM position.

- Set the GUN/PAC switch to either the ARM or GUNARM positions. If ARM is selected, the Precision Attitude Correction (PAC) system will be used when employing the gun. If GUNARM is selected, PAC will be disabled.
- If a Targeting Pod is loaded, move the Laser switch to the ARM position.

Note: Prior to target area ingress, both the Targeting Pod (TGP) and Datalink (JTRS) switches should have been set to the ON position.

Review Digital Stores Management System (DSMS) Pages

- Display the DSMS page on either MFC D to check for any red failure indications, review release profiles, and enable power to the Mavericks if loaded.



Figure 396. DSMS Status Page

- Review DSMS Status page. With the Master Arm switch set to ARM, all 11 stations should show green (empty or solid). A blue or red station requires the following actions:
 - BLUE station.** If a station is colored blue, you must reset the Master Arm switch from TRAIN to ARM.
 - RED station.** A red station generally indicates a profile and inventory conflict. This will happen if a loaded weapon profile includes a weapon that is not loaded on the aircraft. This can be remedied by using DSMS Inventory to set the correct store or clear the station showing the error.

- Review weapon profiles and confirm correct weapon release settings. We will review release settings for different weapon types later in this chapter. To view profile settings:
- Select PROF (Profiles) from the DSMS Status page and this will display the Profile Main Page.

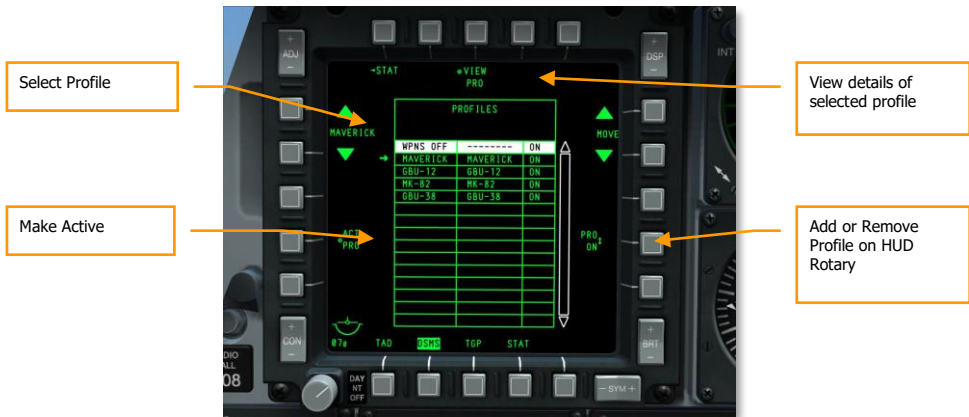

Figure 397. DSMS Main Profile Page

- Select a profile using OSB 19 and OSB 20 and the selected profile will have an arrow to the left. To make the selected profile the active one, press OSB 17 (ACT PRO).
- Add or remove a profile from the HUD Rotary by setting it to ON or OFF from OSB 9.

To view details of the selected profile, press OSB 3, VIEW PRO. This will display the Profile Control page.

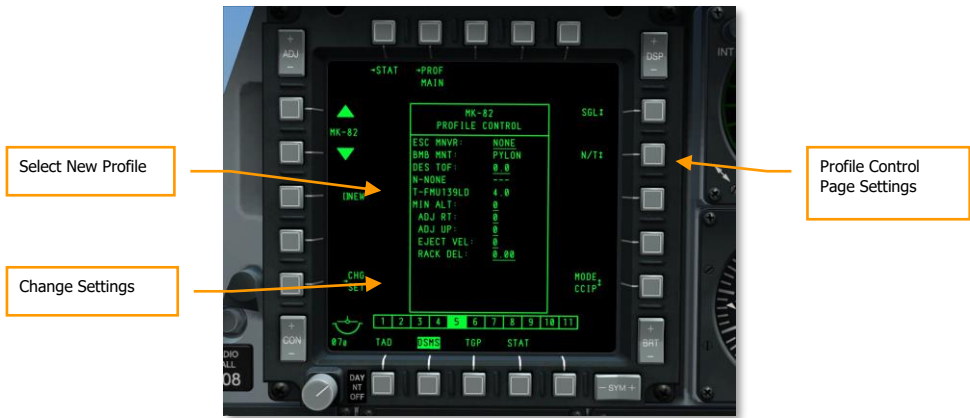

Figure 398. DSMS Profile Control Page

On the Profile Control Page, release settings are displayed on the right side of the page.

On the left side of the page is the Change Settings (CHG SET) OSB that will direct you to the Profile Settings Page where you can set additional release settings of the weapon assigned to the profile.

You can also use OSB 19 and 20 to cycle through Profiles.



Figure 399. DSMS Profile Settings Page

As mentioned before, we will discuss specific control and settings options later in this chapter for each general weapon type.

Hook Tactical Awareness Display (TAD) Objects

Prior to initiating the attack, you may wish to set up the TAD to better support your attack and provide yourself greater situational awareness. This can be done with a combination of joining the Situational Awareness Link (SA Link) network and using the Hook function of the TAD to track navigation points and units with the Hookship symbol on the HUD.

Hooking TAD Objects

One of the more useful aspects of the hook function is to hook a TAD symbol and then have the Hookship box appear on the HUD.

On the TAD, you can also generate useful range and bearing data between the Hooked symbol and either you, bullseye, or the TAD cursor.



Figure 400. TAD Hooking Functions

This can be particularly useful when having the Hookship symbol appear on the HUD and provide you a better cue of where the object is located out in the world. To hook a symbol, place the TAD cursor over it and then press **TMS Forward Short** to active hook it, or just keep the cursor over it to passive hook it. Common and useful objects to hook when preparing for an attack include:

- Your wingmen
- Egress waypoint
- Known enemy threat
- Offset waypoint
- Mission target assignment

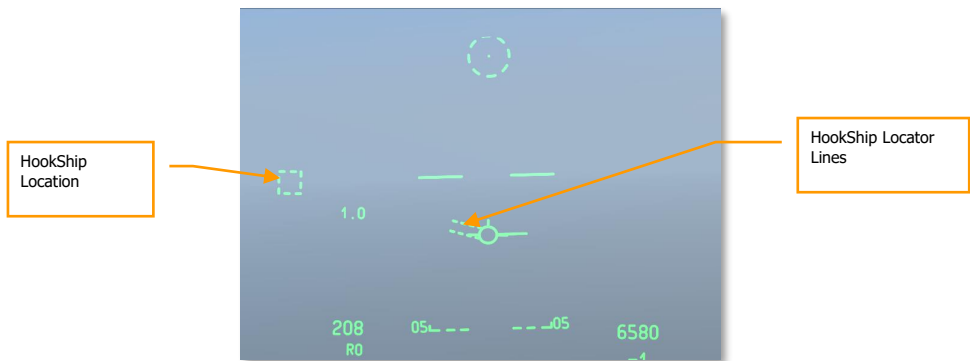

Figure 401. Navigation HUD with Hookship

Targeting Pod (TGP) Set Up

Prior to the attack, the TGP is a valuable tool to visually inspect the area from long range and to mark a SPI. You will want to do this from the TGP A-G page. To bring up the TGP A-G page, you will need to do the following:

1. Select TGP from one of the MFCD
2. When the TGP page is first activated, it will be in Standby (STBY). Press OSB 2 to select A-G



Figure 402. TGP Standby Page

Search Target Area

With the TGP A-G page selected, you can use the infrared and CCD cameras to search the target area for targets and threats. To start with though, you may wish to slave the TGP line of sight to the target area. If there is a waypoint at this area or some other type of TAD object, you can set it as your SPI and then do a TGP slave to SPI command (**China Hat Forward Long**). Here is how you would do that:

1. On the TAD, slew the cursor over the TAD symbol nearest the intended target area.
2. When the cursor is over the symbol, press and hold TMS Forward Long. This sets the location as your SPI.
3. The “wedding cake” SPI symbol will now be shown over the TAD symbol.
4. With the SPI now at the location you want the TGP to look, hold the China Hat on the throttle **China Hat Forward Long**.

The TGP will now be pointed at the SPI location.

Once the TGP is oriented to this location, you can use the following commands to move and adjust the sensor:

- Change Field of View between Narrow and Wide (**China Hat Forward Short**)
- Change camera type between infrared and CCD (**Boat Switch center for CCD**)
- If using infrared camera, change polarity between Black Hot and White Hot (**Boat Switch Forward and Boat Switch Aft**)

- Adjust zoom level (**DMS Forward** and **Aft**)
- Slew camera in horizontal and vertical (Slew Control)

Once you have found a target of interest, you may wish to stabilize the TGP on that location in either an AREA or POINT track. If the target is moving, a POINT track would be your best choice. To toggle between AREA and POINT track press **TMS Forward Short**. If you wish to return to an INR track, press **TMS Aft Short**.

Set SPI with TGP

After you have found a target/location of interest using the TGP, you may wish to set it as the SPI. To do so, press **TMS Forward Long**. This will place the SPI symbol on the TAD at the target location and the diamond TGP symbol on the HUD will now have the SPI line extending from it to the TVV when the symbol is in the HUD field of view. In the case of the diagram below, the TGP point is the SPI but is outside the HUD field of view.



Figure 403. TAD with Hooked SPI

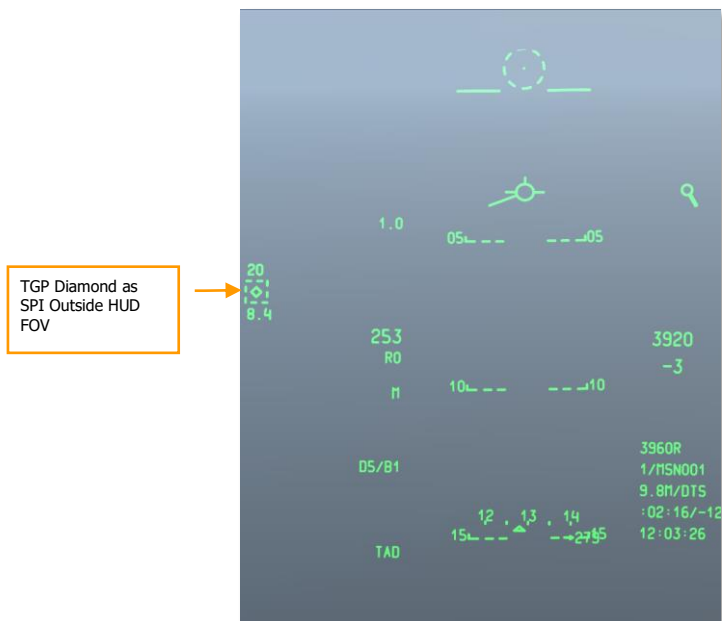

Figure 404. Navigation HUD with TGP as SPI

Once you have set the SPI using the TGP, you can slave other systems like Maverick and the HUD TDC to the SPI by using the "Slave All to SPI" command by pressing **China Hat Forward Long**.

Set Up Laser and LSS

When approaching the target area, you may also either laser a target with your TGP to designate for a flight member or use the TGP to search for and lock on to the laser designation from a flight member or JTAC. Both of these functions can be performed from the TGP A-G page. After displaying the A-G page, you will need to do the following:

Laser Designate Target

Using the laser of the TGP, you can track a target (stationary or moving) using the TGP and then mark it with the encoded laser. A friendly unit using a laser spot tracker can then detect that laser energy and track it assuming both your laser and the laser tracker are set to the same laser code. This can be a useful tool when handing off a target to a wingman or other unit or laser designating a target for a laser-guided bomb attack.

The first thing you need to do is set the laser to a pre-briefing code that both you and the entity to search for the laser spot will use. To do so, go to the A-G Control (CNTL) page.

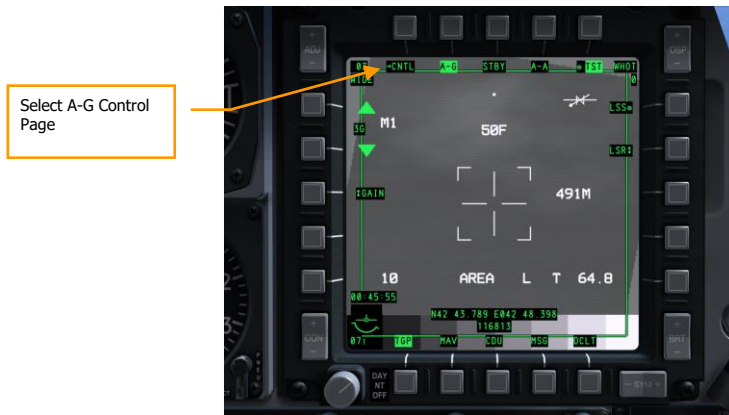

Figure 405. TGP A-G Page

From the A-G Control page, there are two primary settings you will want to make:

1. **Set the laser code.** The default code is 1688, but you can change this by entering the new four-digit code in the scratchpad and then pressing OSB 18 (L).
2. **Set laser illumination to Latch ON or OFF.** With the Latch set to OFF, the laser will fire only as long as you hold down the laser illumination button (Nosewheel Steering Button). With the Latch set to ON, the laser can be toggled On and Off with the nosewheel steering button and does not require you to hold the button down.

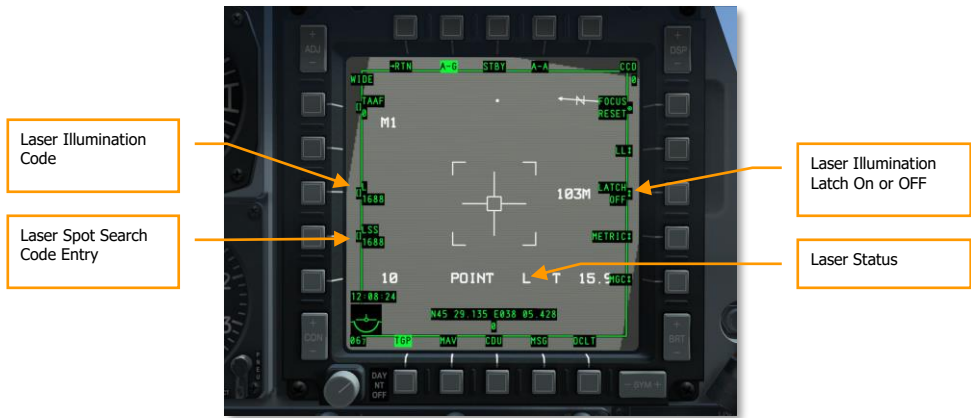

Figure 406. TGP A-G Control Page

After you are tracking the desired target with the TGP and are laser illuminating it, an "L" will appear on the Laser Search Status field on the TGP A-G page. Additionally, a flashing "L" will also appear on the HUD.

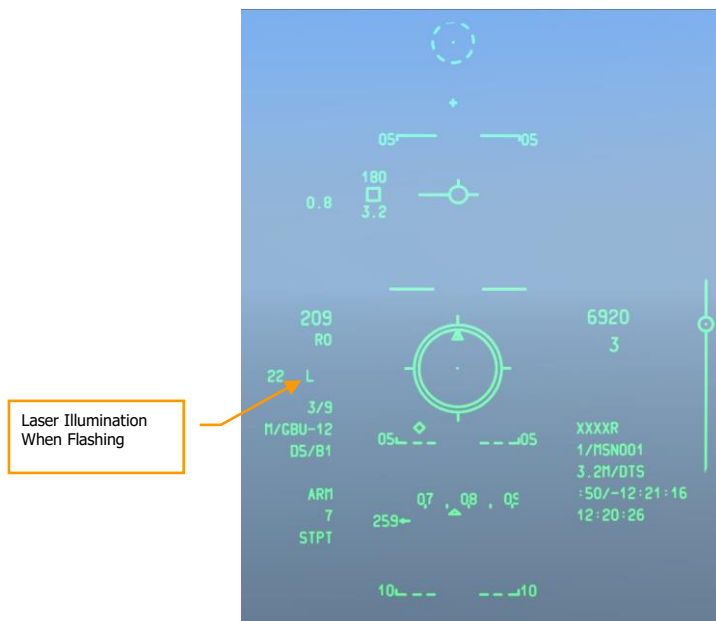

Figure 407. CCRP HUD

Search and Lock Laser Designation

As you have learned to laser designate a target for another aircraft or friendly entity, there may be times when another aircraft or entity may laser designate a target for you. To do so, you will use the Laser Spot Search (LSS) and Laser Spot Track (LST) modes of the TGP. Once you are tracking a laser designated target, you can then easily switch to an AREA or POINT track of that target and engage it.

As with setting up your laser, the first thing you will need to do is go to the A-G Control (CNTL) page and enter the LSS code. As with the Laser code, this defaults to 1688 but any four-digit code may be entered by first typing it into the scratchpad and then pressing OSB 17 (LSS).

After you have set the LSS code for the laser code you want the TGP to search for, return to the main A-G page and either slew or slave the TGP line of sight to the general area you want the TGP to search for the designation laser. With TGP as SOI and the TGP pointed to the target area, initiate LSS mode by pressing OSB 6 (labeled LSS) or **DMS Right Long**. Upon doing so, the TGP video image will freeze, and you will see the Situational Awareness Cue sweep back and forth as the TGP raster scans for the designation.

When a designation has been detected in the searched area at the correct code, a DETECT message will appear on the TGP.

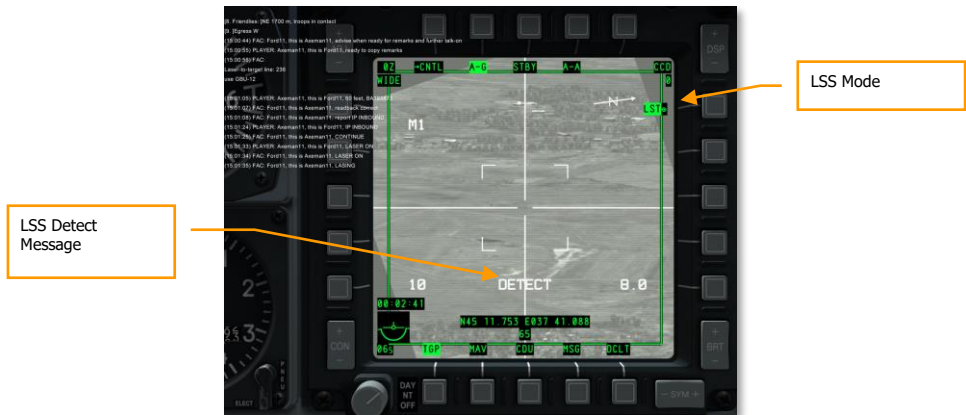

Figure 408. TGP A-G Page

With the laser designation detected, the TGP will then attempt to track the spot and go into Laser Spot Track (LST) mode. This is indicated by LST being displayed next to OSB 6 and the crosshairs will have a point track box in the center. A circle may also appear on the display that indicates where the TGP first detected the laser designation, if the designation point is mobile (like tracking a vehicle).

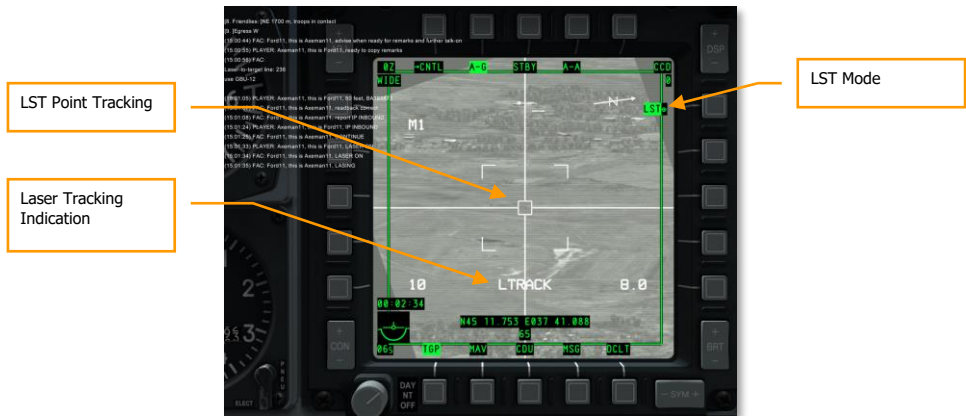

Figure 409. TGP in LST

Now that the designation is being tracked in LST mode, you can switch the track to an AREA or POINT track with **TMS Forward Short**, or an INR track with **TMS Aft Short**.

Gun Employment

Set Up IFFCC 30 MM Menu

From the AHCP, place the IFFCC switch in the TEST position.



Figure 410. Armament HUD Control Panel

From the IFFCC Test Mode displayed on the HUD, use the Select Rocker switch on the UFC to select 30 MM and then press the ENTER button on the UFC.

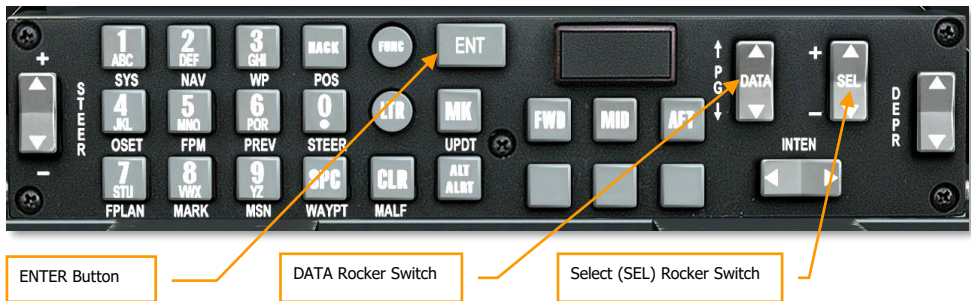

Figure 411. Up Front Control Panel

With the 30 MM menu selected, you have three options to cycle between using the Select Rocker switch on the UFC. When each is selected, you can cycle the options for each by pressing the DATA rocker switch.

AMMO TYPE. Set the ammunition type loaded on the aircraft. The three options include:

- **TP** (Training Practice). Inert warhead rounds used for training.
- **HEI** (High Explosive Incendiary) that only uses high explosive incendiary rounds. Best used for unarmored or lightly armored targets.
- **CM** (Combat Mix) that includes both armor piercing and high explosive incendiary rounds. Best used for armored targets.

Note: You will want to make sure this matches what was loaded on the aircraft in the mission editor and will generally be specified in the mission briefing.

AMMO MFG. Set the ammunition manufacturer. The three options include:

- OLIN
- ALLT
- AVE

Regardless of choice, all rounds have the same properties.

MIN ALT. This value can be set in increments of 100 feet, and it determines the elevation in reference the Gun Minimum Range Cue (MRC) on the HUD.

When you have completed the IFFCC 30 MM settings, place the IFFCC switch to the ON position to show HUD flight symbology.

DSMS Status Page GUNS Indications

In the center of the DSMS Status page is the selected profile and above that is the current Master Mode setting. You can cycle the Master Mode setting between NAV → GUNS → CCIP → CCRP using the **Master Mode Control Button** on the stick. Cycle the Master Mode to GUNS. GUNS will then appear on the DSMS Status page above the Profile name. It will also be briefly displayed in the HUD.

At the bottom of the DSMS Status page is the Gun Status line. This indicates the number of gun rounds remaining and the type of gun rounds loaded (as set on the IFFCC 30 MM menu).

You will next want to ARM and enable the GUN from the AHCP.

1. Set the Master Arm switch to ARM or TRAIN
 - If you set to **ARM**, weapons can be launched from the aircraft and active weapon stations and status are indicated in green.
 - If you set to **TRAIN**, you can practice expending weapons and DSMS and HUD will act accordingly. However, no actual weapons will be released. You may use the DSMS Inventory to assign new station loading or replenish depleted stores. Active weapon stations and status are indicated in blue.
2. Set the GUN/PAC switch to either ARM or GUNARM
 - If you set to **ARM**, the first stage of the trigger will activate the Precision Attitude Control (PAC) system and will attempt to keep the gun piper over the target as long as the trigger is held down. The second stage of the trigger will fire the gun.
 - If you set to **GUNARM**, PAC is disabled, and a second stage trigger pull will fire the gun.

Depending on the settings of the Master and GUN/PAC switches on the AHCP, the data on the DSMS Status page will change accordingly.

Master Arm switch setting. The reverse video color of the selected profile (center of DSMS Status) will indicate the Master Arm switch setting:

- White. SAFE
- Green. ARM
- Blue. TRAIN

The gun rounds remaining counter at the bottom of the DSMS Status page being in video or reverse video, indicates the setting of the GUN/PAC switch.

- Video. SAFE

- Reverse Video. ARM or GUNARM

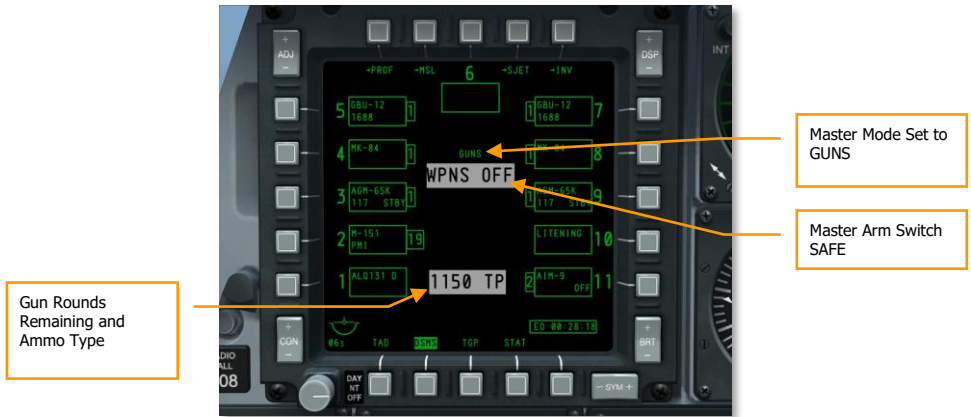

Figure 412. Master and Gun SAFE

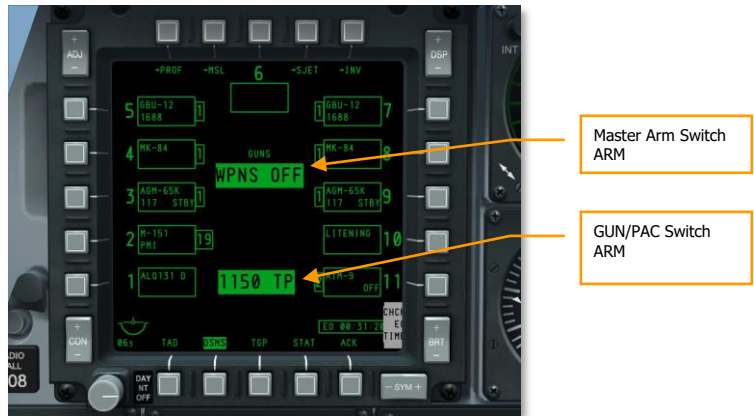

Figure 413. Master and Gun ARMED

Gunsights

With GUNS Master Mode selected and AHCP switches set up correctly, you will now have one of four types of gunsights on the HUD (CCIP Gun Reticle by default). Each of these gunsights provides unique aiming and the choice of them often depends on personal preference or if there is a system failure.

To cycle between the different gunsights, set HUD to SOI and then press the **DMS Left Short**.

CCIP Gun Reticle

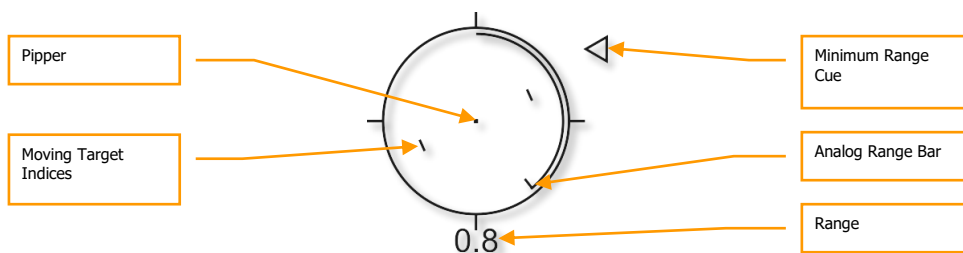

Figure 414. CCIP Gun Reticle

The CCIP Gun Reticle is the default gunsight and provides the most aiming information of the four gunsights. The center of the reticle is the aiming pipper and represents where the gun rounds will go assuming the target is within range. Using the pipper, it is simply a case of “putting the thing on the thing” and pulling the trigger.

When CM ammunition load is selected, there will be two pippers in the center of the reticle. The center most one indicates predicted impact point on Armor Piercing (AP) rounds and the one to the lower right is for High Explosive Incendiary (HEI) rounds. The image above shows the reticle with HEI or TP loading.

If a MIN ALT other than 0 has been entered in the IFFCC 30 MM menu, the Minimum Range Cue indicator will appear to the right of the reticle. The MIN ALT setting is calibrated to when the cue is at the 3 o'clock position of the reticle.

Line of Sight range is indicated by the digital range numeric below the reticle and the analog range bar that winds or unwinds within the reticle.

The reticle contains Moving Target Indices that consist of vertical lines on either side of the pipper. The position represents the lead required for a target moving at 20 knots perpendicular to the LOS.

The Moving Target Indices are roll stabilized such that an imaginary line between the vertical lines passing through the pipper remains parallel to the horizon.

When the reticle does not display true, accurate data, an "X" is drawn in the center.

CCIP Gun Cross

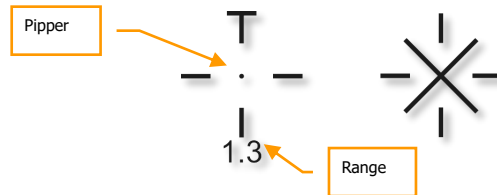

Figure 415. CCIP Gun Cross

The CCIP Gun Cross acts much as the CCIP Gun Reticle but is more compact and removes the analog range bar and Moving Target Indices.

When the CCIP Cross is not providing accurate aiming information, an "X" is drawn through it.

4/8/12 Gun Reticle

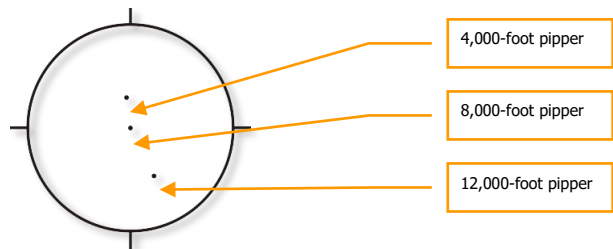

Figure 416. 4/8/12 Gun Reticle

When accurate target elevation is not available, this reticle provides three pippers calibrated to a slant range of 4,000-, 8,000-, and 12,000-feet.

4000-Foot Wind Corrected Gun Cross



Figure 417. 4000-foot Gun Cross

The 4000 ft Gun Cross displays a 4,000-foot, wind-corrected slant range solution. It is primarily used when inaccurate target elevation information prevents an accurate CCIP solution.

Gun Use

When engaging with the gun in a strafing attack, you will want to keep the following points in mind:

To accurately use CCIP gun sights, the aircraft must know the elevation of the aim point. This is most often done by selecting DTS elevation. This is done by first pressing the DATA rocker on the UFC and then the SEL rocker until DTS is displayed on the third line of the HUD data block. If DTS is not selected, the elevation will be based on the steerpoint. If based on steerpoint and the steerpoint is at a higher elevation than where the CCIP gun sight is pointed, you will get a CCIP INVALID error.

Slant range greatly affects gun effectiveness. As the rounds come out of the gun, they will gradually disperse and lose velocity. Increased dispersion and loss of velocity reduce the accuracy and effectiveness of the gun. Effective engagement range generally ranges from .5 to 2 miles slant range. For tanks, .5 miles should be maximum range, and you should attack from behind the target where its armor is weakest using CM.

If the target is moving, you may want to use the moving target indices on the CCIP Gun Reticle. They assume lead for a moving target at a constant speed of 20 knots perpendicular. For example: if a target is moving left to right at an estimated 10 knots, place target halfway between the pipper and left moving target indices before firing.

When lining up a shot, be careful to avoid target fixation. Target fixation can lead to you not noticing an unseen threat or pressing the attack too close. Don't make yourself an easy target for the machine gun on the top of that tank!

Once you have reached the minimum attack range, break off in both the horizontal and vertical to avoid hostile return fire. You may also wish to release flares in case an infrared-SAM near the enemy target has been launched at you, but you did not see it.

Prior to the strafing attack, you may want to track the target using the targeting pod so that you can perform a battle damage assessment while coming off the target. Be careful not to spot your target though!

If the expected target is enemy infantry, it is best to load the aircraft with an HEI gun load.

Gun Strafe Not Using Precision Attitude Control (PAC)

When engaging a target with the gun and the GUN/PAC switch set to GUNARM, the PAC will not be used. As such, you will want to keep the following points in mind for a successful strafing attack:

Armored/fortified targets are best attacked from a High Angle Strafe in order to increase round density on target. The further away you engage, the lower the round density on the target will be. Generally, conduct a strafe between 2 and .5nm. For heavily armored targets like tanks, it is best to fire between .5 and 1 nm.

Area targets or lightly armored targets can be attacked in a Low Angle Strafe due to the increased round dispersion over an elongated area.

Gun Strafe Using PAC

PAC assists by stabilizing the aircraft during strafing and allowing much greater round density on target because the pitch and yaw will be controlled during gunfire to keep the rounds from walking from the initial target point. PAC does this by applying elevator and rudder control through the SAS to stabilize the aircraft's nose during gun fire.

CCIP INVALID HUD Message

If the target is at an elevation higher than the current aircraft altitude (target on a hill higher than your current altitude for instance), the system cannot generate proper target altitude and a "CCIP INVALID" message will appear on the HUD. To attack such a target accurately, you have two options:

- Increase altitude above target altitude
- Switch to 4/8/12 Gun Reticle or 4000-Foot Wind Corrected Gun Cross

Unguided Rocket Employment

DSMS Rocket Pages

On the DSMS Status page, stations loaded with rockets will contain the following information:



Figure 418. Rocket Loaded Station

- Top line indicates the warhead type of the rocket
- Bottom line indicates role of the rocket
- Left or right of box is the number of rockets remaining on the station

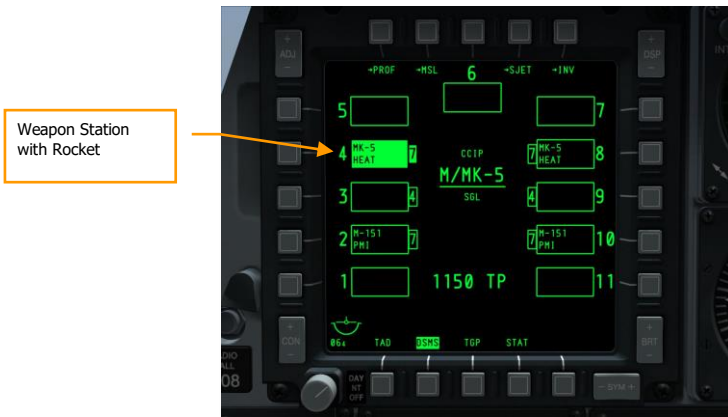

Figure 419. DSMS Status Page, Rocket Profile Selected

DSMS Control Page for Rockets

There are three release settings available for rockets on the Control Page.

- **Release Type** (OSB 6). Cycle this option to choose between four release types:
 - **SGL** (Singles). Each press of the **weapon release button** will launch a single rocket.
 - **PRS** (Pairs). Each press of the **weapon release button** will launch a single rocket from two different pods.
 - **RIP SGL** (Ripple Singles). Each press of the **weapon release button** will launch the number of rockets specified in the RIP QTY (Ripple Quantity) setting.
 - **RIP PRS** (Ripple Pairs). Each press of the **weapon release button** will release the number specified in the RIP PRS setting, in pairs.

Note: When releasing a ripple of rockets, they will land centered around the pipper aimpoint.

- **Ripple Quantity** (OSB 8). If either RIP SGL or RIP PRS are selected as the Release Type, you may use this to set the number of rockets to release in each ripple.
- **Release Mode** (OSB 10). Select to release rocket in CCIP or CCRP release modes. This setting, along with being assigned to the HUD rotary, will determine if the profile is selected in the CCRP or CCIP rotary.

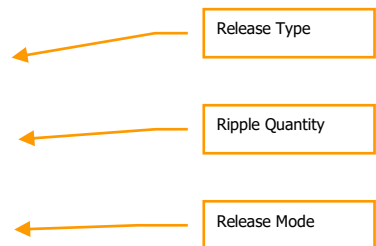

Figure 420. DSMS Profile Control Page, Rocket Profile**DSMS Settings Page for Rockets**

On the Settings page for a rocket profile, you have additional setting options. Note that some settings may not be available for all types of rockets. For instance, explosive warheads and illumination warheads may differ.

Escape Maneuver (OSB 20). Select type of escape maneuver between:

- NONE
- CLM. Climbing maneuver
- TRN. Turning maneuver
- TLT. Turn Level Turn maneuver

Desired Time of Flight (OSB 19). Set desired time of flight of rocket from launch to time of impact.

Minimum Altitude (OSB 18). Used to set Minimum Range Caret (MRC) for illumination flare activation.

Horizontal Offset (OSB 7). Set horizontal offset of weapon between -15 and +15 mils.

Vertical Offset (OSB 8). Set vertical offset of weapon between -15 and +15 mils.

Weapon Eject Velocity (OSB 9). Set ejection velocity of pod between -10 and +30 feet per second.

Bomb Rack Delay (OSB 10). Set bomb rack delay between -0.40 and +0.40.

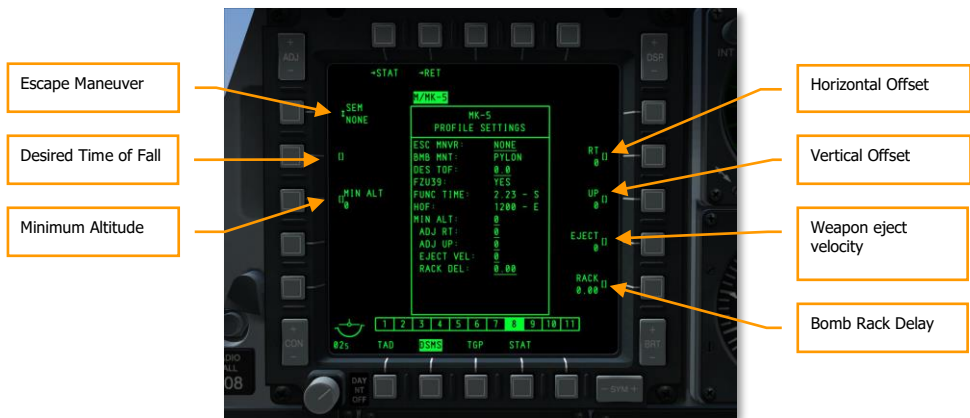

Figure 421. DSMS Profile Settings Page, Rocket Profile

Unguided Rocket CCIP Use

With a rocket profile selected and configured, and the Master Arm switch set to ARM, you can put some rockets down range. You can either deliver rockets in CCIP or CCRP mode. Both have their advantages and disadvantages.

To most easily select rockets in CCIP mode, set the HUD as SOI and:

1. Select CCIP mode by pressing the **Master Mode Control Button** until selected. The current mode is displayed in the center of the HUD.
2. Press the **DMS Left or Right Short** until you select a rocket profile. The profile name is both listed on the DSMS Status page and in the bottom left corner of the HUD.

Much like the CCIP Gun Reticle, you will place the CCIP Rocket Reticle over the target by maneuvering the aircraft. When greater than 2 nm slant range, the range to target will be displayed below the reticle as a numeric. On the left side of the HUD, the projected flight time of the rocket if fired now is displayed.

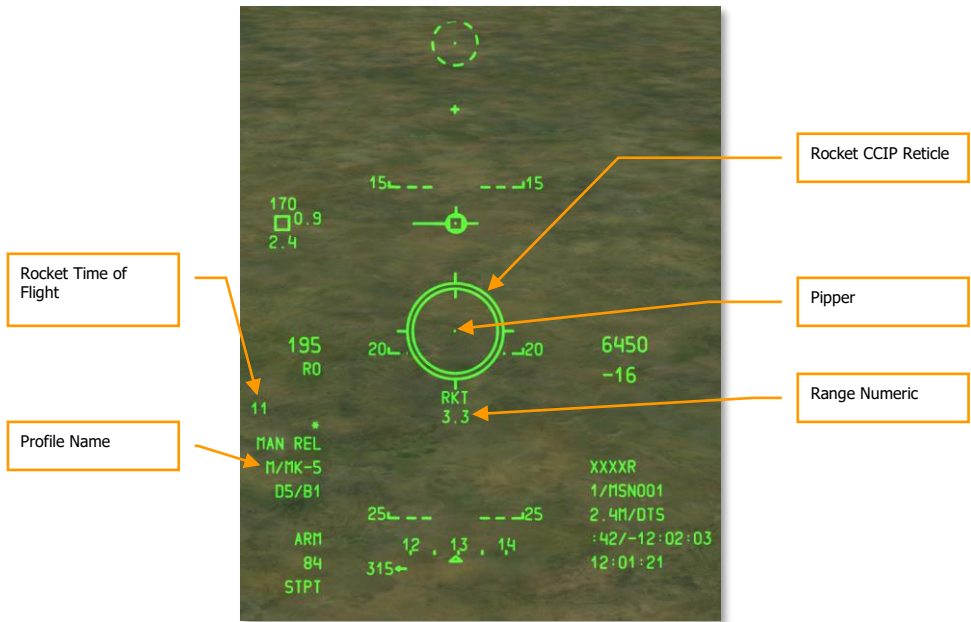

Figure 422. CCIP Rocket HUD, Out of Range

When the slant range to target is less than 2 nm, the range numeric under the CCIP reticle is removed and the analog range bar within the reticle starts to unwind.

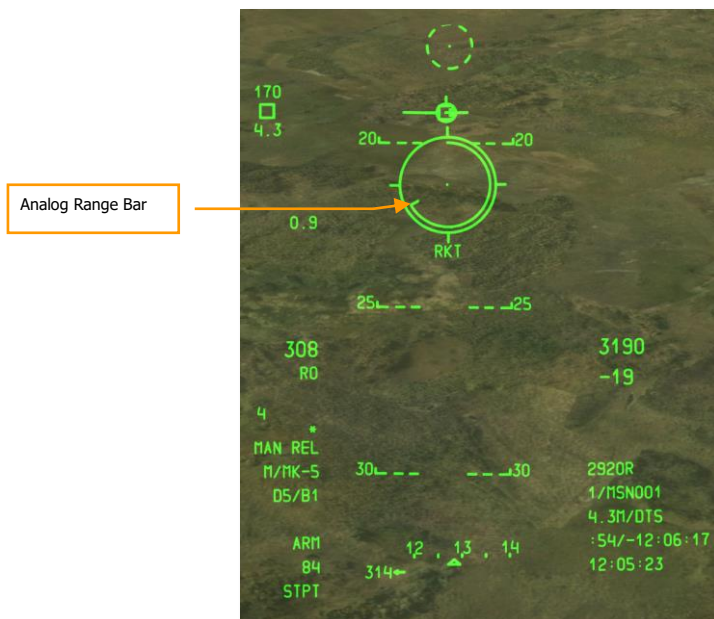

Figure 423. CCIP Rocket HUD, In Range

At around 1 nm, hold down the **weapon release button** to launch rockets.

The main advantage to using CCIP mode to deliver rockets is that it is more accurate than CCRP mode. The disadvantage is that it generally requires you to get closer to the target and keep your nose on it.

To accurately use the CCIP rocket sight, the aircraft must know the elevation of the aim point. This is most often done by selecting DTS elevation. This is done by first pressing the DATA rocker on the UFC and then the SEL rocker until DTS is displayed on the third line of the HUD data block. If DTS is not selected, the elevation will be based on the steerpoint. If based on steerpoint and the steerpoint is at a higher elevation than where the CCIP sight is pointed, you will get a CCIP INVALID error.

Unguided Rocket CCRP Use

CCRP rocket delivery mode allows you to launch rockets in reference to the SPI and can be done from level flight or even a lofting delivery. Before using this mode, you will first need to designate the intended target as the SPI. This could be done with the TDC, TAD, Maverick, Gun piper or TGP.

Once the target is set as SPI, select a rocket profile and set the master mode to CCRP.

Upon doing so, a vertical Azimuth Steering Line (ASL) will be drawn on the HUD along the heading to the SPI. A short distance from the top of the ASL is a small circle with a dot inside called the Solution Cue.

Also on the HUD will be the rocket reticle, but unlike CCIP mode, there will be no range numeric or analog bar.

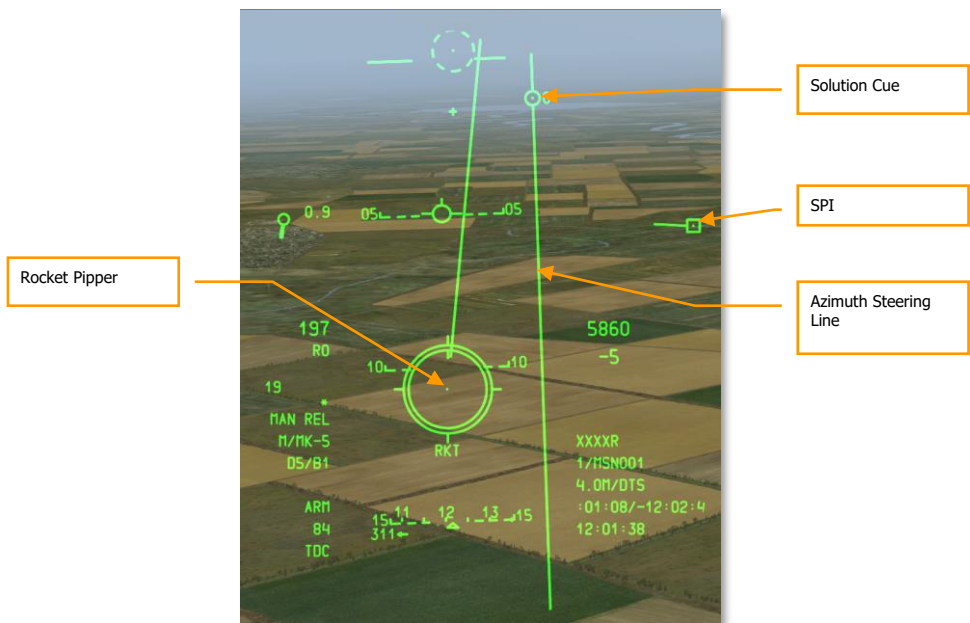

Figure 424. CCRP Rocket HUD

To aim and fire rockets, you must fly the aircraft to place the rocket reticle pipper inside the small Solution Cue. In doing so, you align the aircraft along the proper heading and attitude to launch rockets for impact at the SPI location.

Note that this can happen quickly, and you may need to launch several rockets in a short time before you can no longer keep the pipper in the Solution Cue.

The advantage of rocket CCRP delivery is that you can engage from further way while in level flight or even pitched-up to loft rockets. The disadvantage is that it can be much less accurate than CCIP delivery. You would generally use CCRP mode against a heavily defended target in order to suppress it.

Advanced Precision Kill Weapon System (APKWS)

In addition to a large selection of unguided 2.75-inch rockets, the APKWS laser-guided rocket system is also available. The APKWS, also displayed as the AGR-20A, combines a standard 2.75-inch high-explosive rocket with a laser guidance kit and control fins.

There are two warhead options:

- M-151 with a high-explosive
- M-282 with a penetrator warhead

From the DSMS Inventory (INV) page for ROCKETS, the laser PRF can be set. It will default to 1688, can be edited to match the targeting pod illumination PRF frequency.



Figure 425. APKWS DSMS Options

There is no unique rocket HUD symbology for the ARG-20A other than the weapon name. The system is optimized for CCIP use, and once the designation-laser is illuminating the target on the same PRF as the APKWS, the rocket is launched as it would be for an unguided rocket. With the added laser-guidance, accuracy is significantly improved.

Maximum range is between 5.0 and 6.0 nm based on launch altitude.

Given the rather small size of the warhead, this weapon is best used against unarmored or lightly armored units. It should not be used against tanks and other heavily armed vehicles.

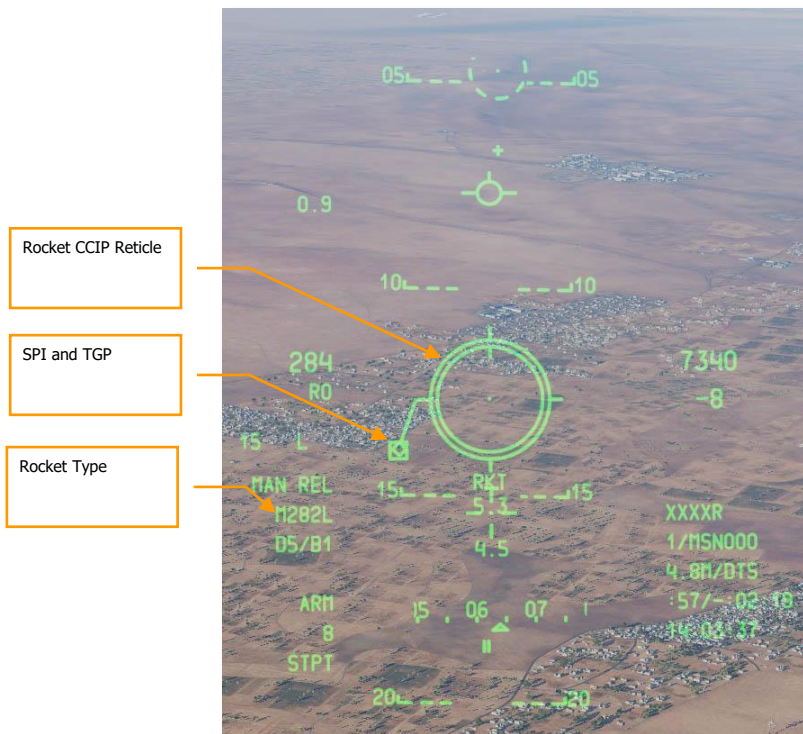

Figure 426. APKWS HUD Symbology

Unguided Bomb Employment

Set Up IFFCC Menu

If you wish to deliver an unguided bomb in CCIP mode, you have the option to do so in Manual Release (MAN REL), 3/9 Consent to Release, and 5 Mil Consent to Release (CR) modes. While Manual Release is used as the default, you can select 3/9 or 5 MIL CR from the IFFCC Test menu. To do so:

1. Place the IFFCC switch on the AHCP in the TEST position
2. With the CCIP CONSENT OPT line selected, press the DATA rocker on the UFC to cycle between the three options
3. When complete, move the IFFCC switch to the ON position

DSMS Unguided Bomb Pages

When an unguided bomb has been loaded on one of the 11 weapon stations and it has a corresponding weapon profile, its data will be shown in the appropriate weapon station box.

You can directly select the weapon by pressing the OSB next to the weapon station box and creating a Manual profile of the selected weapon type (M/weapon name).

The selected weapon type (by Profile or Manual) will have its weapon station boxes shown in reverse video.

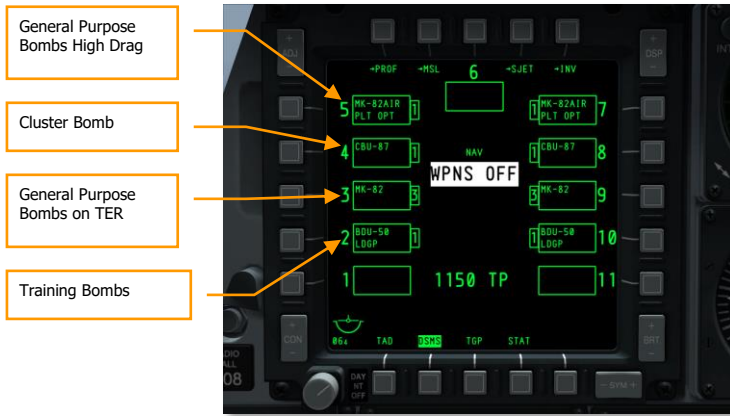

Figure 427. DSMS Status Page

DSMS Status Page Weapon Station Boxes

According to the type of unguided bomb, the information in the weapon box on the Status page varies:

- Top line indicates the weapon type (e.g., MK-82)
- Bottom will either be blank, show the Pilot Release Option, or indicate TER
- Left or right of box is the number of bombs remaining on the station



Figure 428. MK-82 Station Box

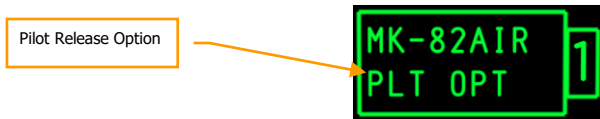

Figure 429. MK-82AIR Station Box

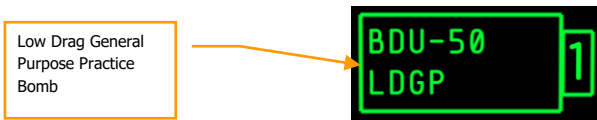

Figure 430. BDU-50 Low Drag General Purpose Practice Bomb

Unguided Bomb DSMS Pages

The following setup sections will show configuration options to deliver the three general types of unguided bombs.

DSMS Control Page for General Purpose (Low Drag) and Cluster Bomb

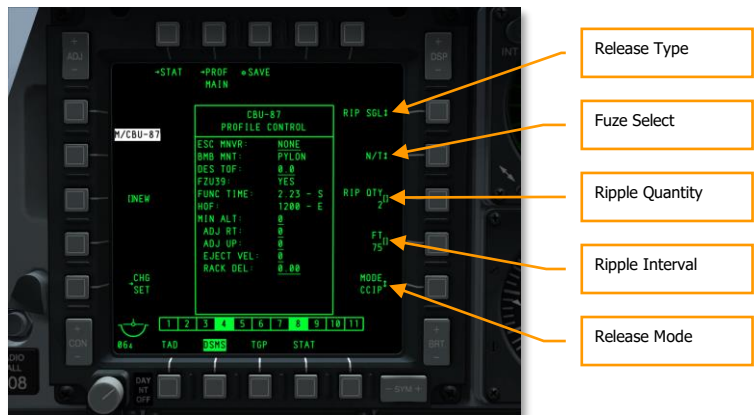

Figure 431. DSMS Profile Control Page, Unguided Bombs

There are four possible release settings available for general purpose bombs on the Control Page.

Release Type (OSB 6). Cycle this option to choose between four release types:

- **SGL** (Singles). Each press of the **weapon release button** will release a bomb.
- **PRS** (Pairs). Each press of the **weapon release button** will release two bombs from opposed wing stations.
- **RIP SGL** (Ripple Singles). Each press of the **weapon release button** will release the set number of bombs set from the RIP QTY (Ripple Quantity) setting.

- **RIP PRS** (Ripple Pairs). Each press of the **weapon release button** will release the number of bombs specified in the RIP PRS setting, in pairs.

Note: When releasing a ripple of bombs, they will land centered around the piper aimpoint.

Fuze Select (OSB 7). Cycle this option between NOSE, TAIL, and N/T (Nose and Tail).

Ripple Quantity (OSB 8). If either RIP SGL or RIP PRS are selected as the Release Type, you may use this to set the number of bombs to release in each ripple.

Release Mode (OSB 10). Select to release bomb(s) in CCIP or CCRP release modes. This setting, along with being assigned to the HUD rotary, will determine if the profile is selected in the CCRP or CCIP rotary.

DSMS Settings Page for General Purpose and Cluster Bomb



Figure 432. DSMS Profile Settings Page, Unguided Bombs

On the Settings page for a general-purpose bomb profile, you have additional settings options.

Escape Maneuver (OSB 20). Select type of escape maneuver between:

- NONE
- CLM. Climbing maneuver
- TRN. Turning maneuver
- TLT. Turn Level Turn maneuver

Desired Time of Fall (OSB 19). Set desired time of fall in seconds of the bomb from release to time of impact. The time set will determine the Desired Release Cue (DRC) location on the Projected Bomb Impact Line (PBIL). If you wish to have the bomb drop according to the set TOF, keep the DRC on the target when bombing piper is over the target. When the DRC and the bombing piper coincide, release the bomb and it will have the inputted TOF.

Minimum Altitude (OSB 18). Used to set the minimum weapon release altitude cues on the HUD. This setting will determine the placement of the Minimum Range Staple (MRS) on the PBIL and the Minimum Range Caret (MRC) within the CCIP HUD reticle.

Horizontal Offset (OSB 7). Set horizontal offset of weapon between -15 and +15 mils.

Vertical Offset (OSB 8). Set vertical offset of weapon between -15 and +15 mils.

Weapon Eject Velocity (OSB 9). Set ejection velocity of pod between -10 and +30 feet per second.

Bomb Rack Delay (OSB 10). Set bomb rack delay between -0.40 and +0.40.

DSMS Control Page for General Purpose Bomb, High Drag

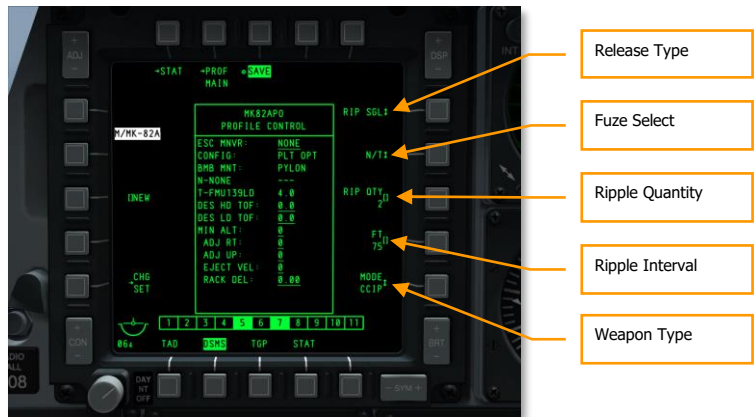

Figure 433. DSMS Profile Control Page, High Drag Unguided Bombs

There are four possible release settings available for general purpose high drag bombs on the Control Page.

Release Type (OSB 6). Cycle this option to choose between four release types:

- **SGL** (Singles). Each press of the **weapon release button** will release a bomb.
- **PRS** (Pairs). Each press of the **weapon release button** will release two bombs from opposed wing stations.
- **RIP SGL** (Ripple Singles). Each press of the **weapon release button** will release the number of bombs specified in the RIP QTY (Ripple Quantity) setting.
- **RIP PRS** (Ripple Pairs). Each press of the **weapon release button** will release the number of bombs specified in the RIP PRS setting, in pairs.

Note: When releasing a ripple of bombs, they will land centered around the pipper aimpoint.

Fuze Select (OSB 7). Cycle this option between NOSE, TAIL, and N/T (Nose and Tail). If a MK82AIR is selected, setting the fuze to NOSE will have the bomb drop without the ballute deploying (low drag). If, however, you select N/T or TAIL, the bomb will be dropped as a high drag bomb with the ballute deploying.

Ripple Quantity (OSB 8). If either RIP SGL or RIP PRS are selected as the Release Type, you may use this to set the number of bombs to release in each ripple.

Release Mode (OSB 10). Select to release bombs in CCIP or CCRP release modes. This setting, along with being assigned to the HUD rotary, will determine if the profile is selected in the CCRP or CCIP rotary.

DSMS Settings Page for General Purpose Bomb, High Drag

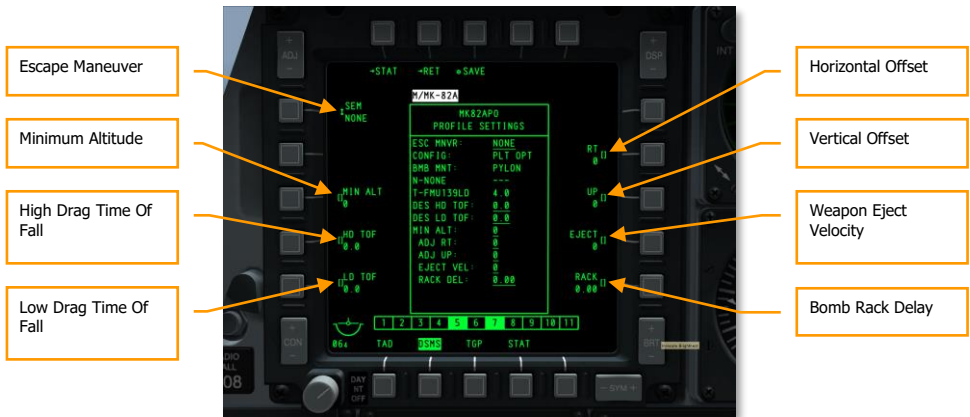

Figure 434. DSMS Profile Settings Page, High Drag Unguided Bombs

On the Settings page for a general-purpose bomb high drag profile, you have additional setting options.

Escape Maneuver (OSB 20). Select type of escape maneuver between:

- NONE
- CLM. Climbing maneuver
- TRN. Turning maneuver
- TLT. Turn Level Turn maneuver

Minimum Altitude (OSB 18). Used to set the minimum weapon release altitude cues on the HUD. This setting will determine the placement of the Minimum Range Staple (MRS) on the PBIL and the Minimum Range Caret (MRC) within the CCIP HUD reticle.

High Drag Time of Fall (OSB 17). Set desired time of fall in seconds of the bomb from release to time of impact when it is set to high drag pilot option release mode. The time set will determine the Desired Release Cue (DRC) location on the Projected Bomb Impact Line (PBIL). If you wish to have the bomb drop according to the set TOF, keep the DRC on the target when bombing pipper is over the target.

Low Drag Time of Fall (OSB 16). Set desired time of fall in seconds of the bomb from release to time of impact when it is set to low drag pilot option release mode. The time set will determine the Desired Release Cue (DRC) location on the Projected Bomb Impact Line (PBIL). If you wish to have the bomb drop according to the set TOF, keep the DRC on the target when bombing pipper is over the target.

Horizontal Offset (OSB 7). Set horizontal offset of weapon between -15 and +15 mils.

Vertical Offset (OSB 8). Set vertical offset of weapon between -15 and +15 mils.

Weapon Eject Velocity (OSB 9). Set ejection velocity of pod between -10 and +30 feet per second.

Bomb Rack Delay (OSB 10). Set bomb rack delay between -0.40 and +0.40.

CCIP Bombing Use

Having configured your profile and possible inventory settings for an unguided bomb delivery, we will now discuss delivery HUD symbology and steps when using the Continuously Computed Impact Point (CCIP) weapon delivery method. We can do so in either manual release (MAN REL) mode or one of two Consent to Release (CR) modes.

Manual Release (MAN REL)

Manual release is the default release mode in CCIP and requires no change to IFFCC TEST settings. Much like rocket and gun CCIP delivery, it is a case of placing the reticle pipper over the target and then releasing the weapon. Quite simple! To deliver an unguided bomb using CCIP manual release:

1. Set the Master Arm switch on the AHCP to ARM.
2. Press the **DMS Left or Right Short** until the desired weapon profile is selected.
3. Press the **Master Mode Control Button** until CCIP is selected (as displayed in the center of the HUD).

If wings level, a dashed Projected Bomb Impact Line (PBIL) will appear. You want to keep the wings as level as possible and avoid banking left and right. Doing so will cause the PBIL to swing left and right and cause a windshield wiper effect.

Start a shallow dive between 10 and 45 degrees towards the intended target.

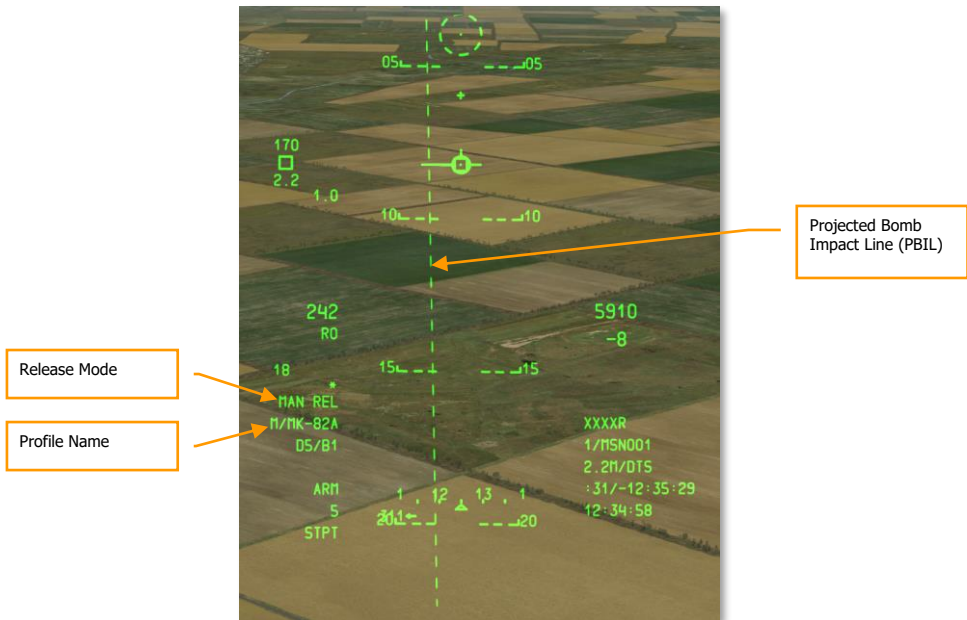

Figure 435. CCIP Bombing HUD, Out of Solution

Depending on range and altitude to target, the CCIP Bombing Reticle will come into view from the bottom of the HUD and the PBIL will turn from dashed to solid. The reticle and the pipper in the center represent where the bomb(s) will drop if the **weapon release button** is pressed.

Maneuver the aircraft to place the pipper over the target and then hold down (do not just tap) the **weapon release button**. If dropping multiple bombs in a ripple mode, you must hold down the **weapon release button** as long as it takes for all the bombs to be released.

In the lower left side of the HUD is a countdown numeric that indicates the time until the first bomb will impact.

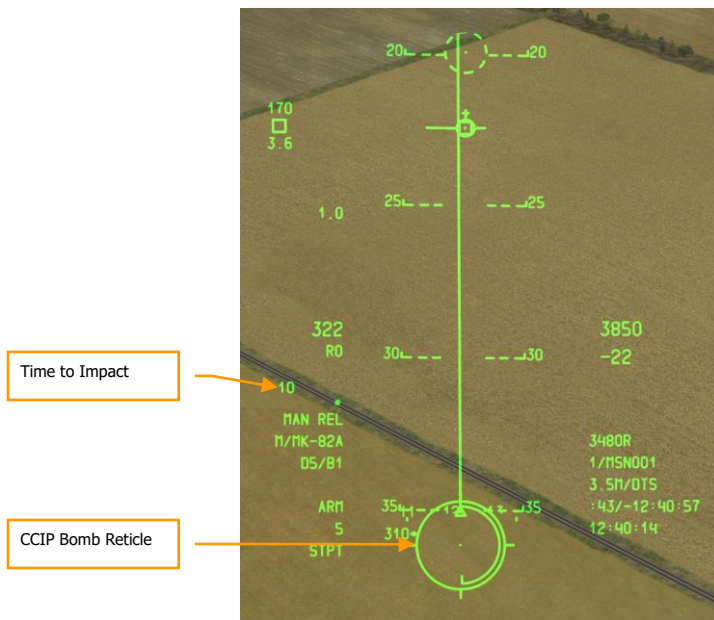

Figure 436. CCIP Bombing HUD, In Solution

Consent to Release (CR) (3/9 or 5 MIL)

The two CR modes allow you to designate a target much as you would attack it with a CCIP Manual Release attack, and then pull up out of the attack with the target well below the HUD lower field of view. This can be a useful delivery when you want to reduce the time you are in an attack dive and it allows you to start your escape maneuver earlier.

To use a CR mode, you will need to do the following:

From IFFCC Test menu, select the CCIP CONSENT OPT, press the DATA rocker on the UFC to select either 3/9 or 5MIL. By default, this will be set to OFF which provides Manual Release. When complete, place the IFFCC switch in the ON position.

When you are pitched down more than 3 degrees, a dashed PBIL and reticle will appear on the HUD. The reticle with central pipper will stay clamped to the bottom of the HUD. Maneuver the aircraft to place the pipper over the intended target and then press and **HOLD** the **weapon release button**.

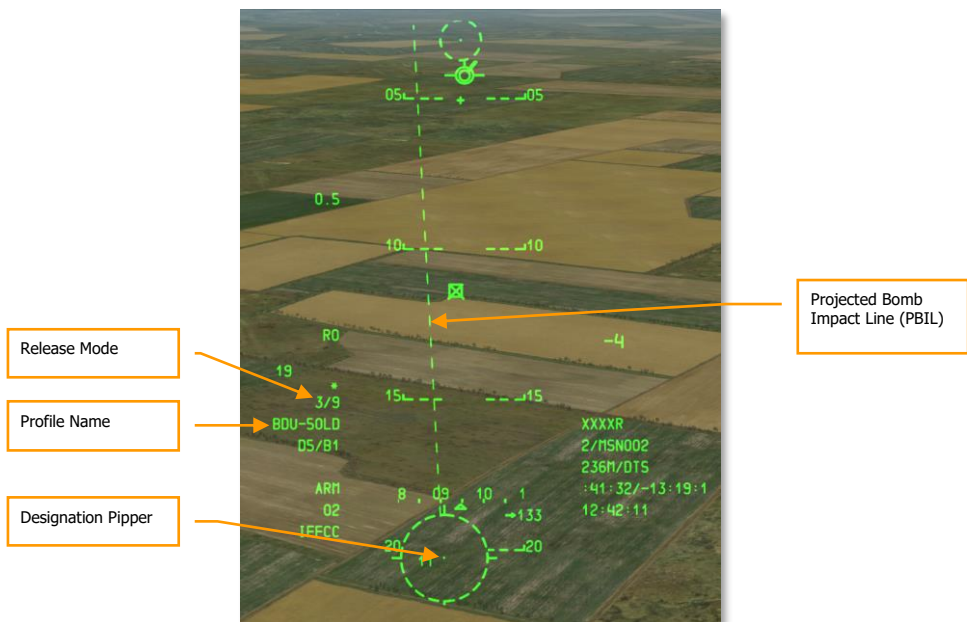

Figure 437. CCIP CR Bombing HUD, Out of Solution

With the **weapon release button** held down, the PBIL will turn solid, and an Azimuth Steering Line (ASL) will appear along the heading to the designated target. On the ASL a small circle will appear called the Solution Cue and next to the cue is the Time to Release Numeric (TTRN).

As you fly to the target along the ASL, the Solution Cue and ASL will start to drop down on the HUD. You must maneuver the aircraft such that the solution cue passes through the pipper of the reticle if

5 MIL is selected. If 3/9 is selected, the Solution Cue simply needs to pass left or right of the reticle. The TTRN indicates the time in seconds until the weapon should be released.

With the **weapon release button** still held down and the Solution Cue passing past the pipper / reticle, the bomb(s) will automatically be released.

After the bomb(s) have been released, you can release the **weapon release button**.

In the lower left side of the HUD is a countdown numeric that indicates the time until the first bomb will impact.

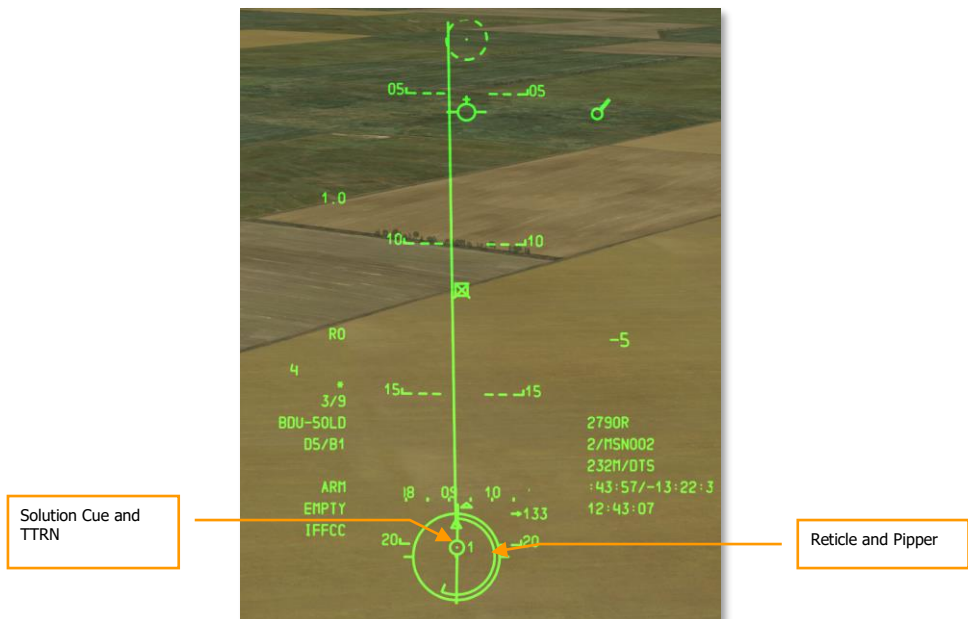

Figure 438. CCIP CR Bombing HUD, In Solution, Pre-release

If the aircraft computes that the current flight conditions will not allow the solution cue to fall through the 5 MIL (if 5 MIL selected), an X will appear through the Solution Cue.

Note: To accurately use CCIP bombing, the aircraft must know the elevation of the aim point. This is most often done by selecting DTS elevation. This is done by first pressing the DATA rocker on the UFC and then the SEL rocker until DTS is displayed on the third line of the HUD data block. If DTS is not selected, the elevation will be based on the steerpoint. If based on steerpoint and the steerpoint is at a higher elevation than where the CCIP pipper is pointed, you will get a CCIP INVALID error.

CCRP Bombing Use

Continuously Computed Release Point (CCRP) mode allows you to attack a designated ground point based on SPI location. Like CCIP, this could be done from a dive, but also from wings-level or a nose-high attitude.

To use a CCRP mode, you will need to do the following:

1. Set the Master Arm switch on the AHCP to ARM.
2. Press the **DMS Left or Right Short** until the desired weapon profile is selected.
3. Press the **Master Mode Control Button** until CCRP is selected (as displayed in the center of the HUD).
4. Set desired target as SPI. There are several ways you can set the target as SPI, which includes:
5. Move TDC over target and press **TMS Forward Long** to set as SPI
6. Move TGP cursor over target and press **TMS Forward Long** to set as SPI
7. Lock target with Maverick and press **TMS Forward Long** to set as SPI
8. Set any TAD object as SPI

When the SPI has been set, the Azimuth Steering Line (ASL) on the HUD will indicate heading to SPI (target).

The designated target SPI will also have a SPI locator line extending from it to the TVV, or the TVV will have a SPI locator line extending to the target; depending on if the SPI target is within the HUD field of view.

9. Maneuver the aircraft to align the CCRP Projected Bomb Release Line (PBRL) with the ASL. The CCRP pipper should lay along the ASL.

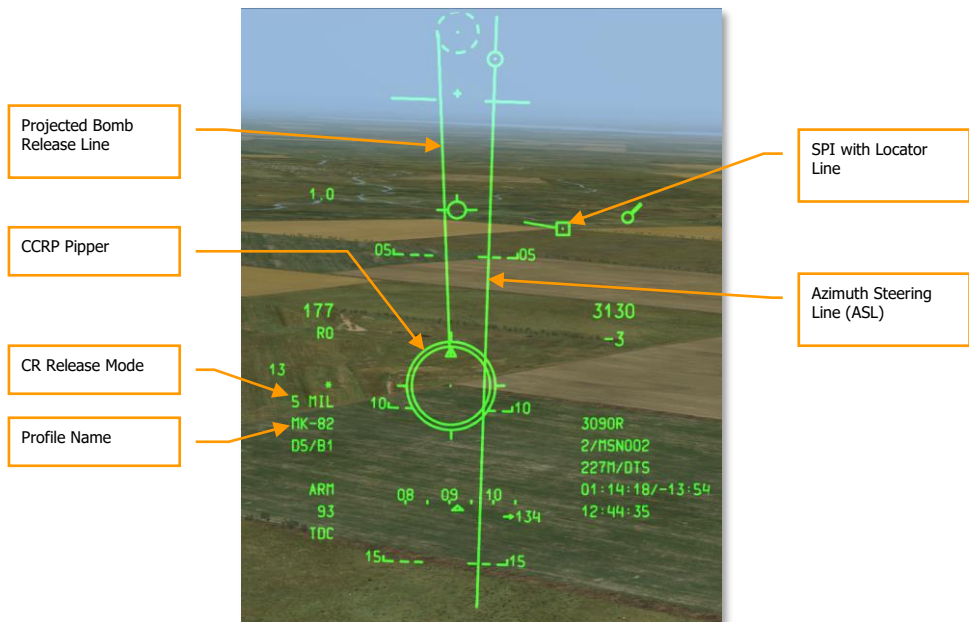

Figure 439. CCRP Bombing HUD, Pre-release

As you near the SPI target, the Time to Release Numeric (TTRN) next to the Solution Cue on the ASL will indicate the time in seconds until the weapon should be released.

10. At about 6 seconds on the TTRN, the Solution Cue will start to fall down the ASL. Hold down the **weapon release button** and maneuver the aircraft so that the Solution Cue falls through the CCRP piper. CCRP mode only uses 5 MIL mode; MAN REL and 3/9 are not options.
11. After the bomb(s) have been released, you can release the **weapon release button**.

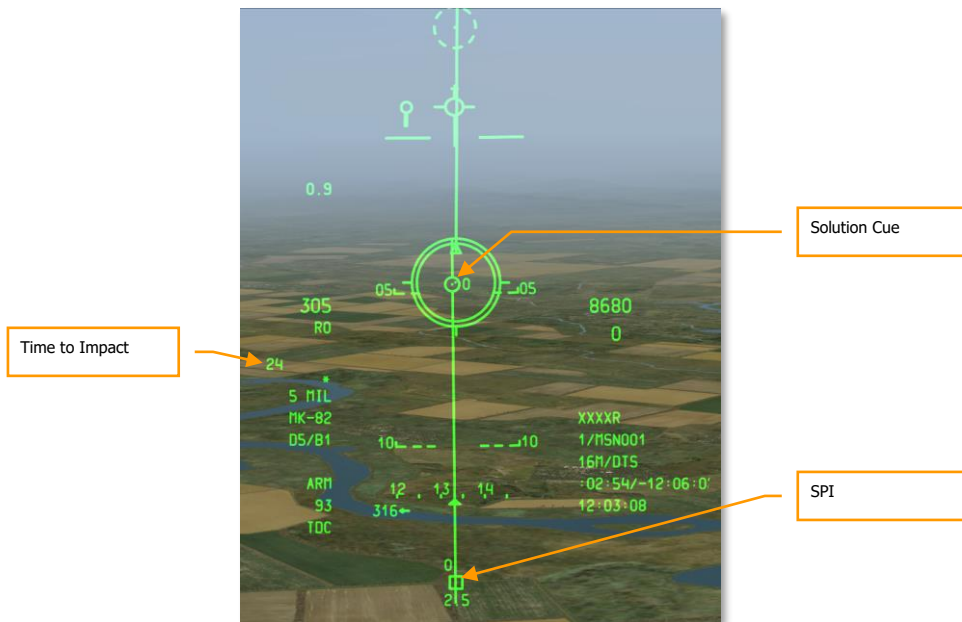

Figure 440. CCRP Bombing HUD. In Solution at Release

If the aircraft computes that the current flight conditions will not allow the solution cue to fall through the 5 MIL (if 5 MIL selected), an X will appear through the Solution Cue.

Illumination Flare Employment

DSMS Illumination Flare Pages

Regardless of how many stations are loaded with the same type of illumination flare, only one station can be selected at a time when selected as a profile. To cycle between stations loaded with the same illumination flare type, cycle through the HUD rotary using **DMS Left** or **Right Short** when HUD is SOI.

On the DSMS Status page, each station loaded with an LUU series will have the following information in its station box:

- Top line lists the name of the flare type
- Bottom line lists the name of the container pod (always SUU25)

To the right or left of the station box is the number of flares remaining on that station

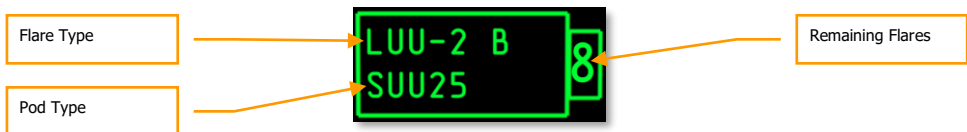

Figure 441. Illumination Flare Station Box

DSMS Status page for Illumination Flare

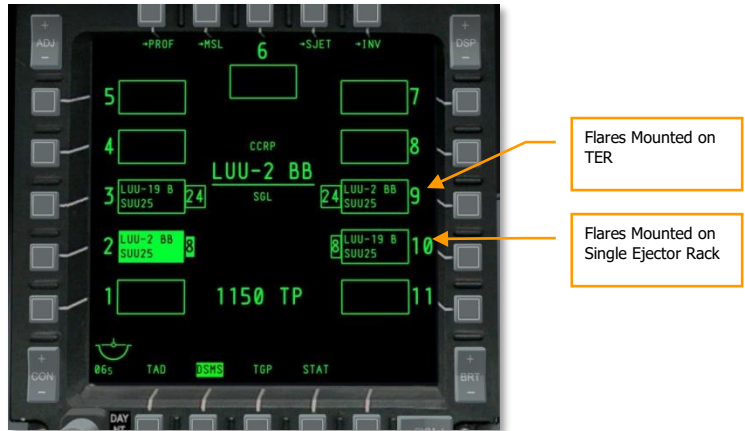

Figure 442. DSMS Status Page

DSMS Control Page for Illumination Flare

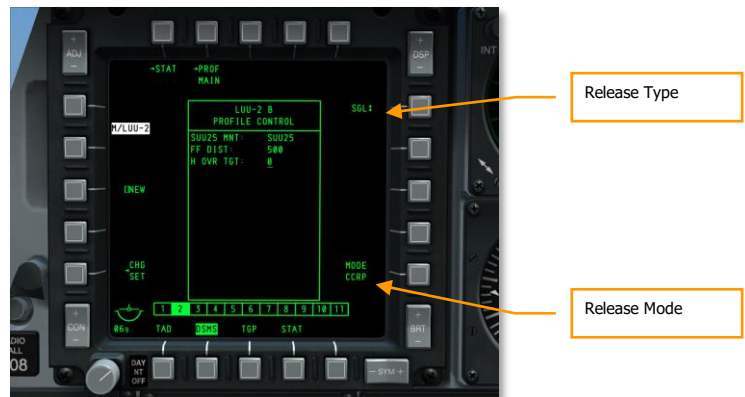

Figure 443. DSMS Profile Control Page, Illumination Flares

Release Type (OSB 6). Cycle this option to choose between two release types:

- **SGL** (Singles). Each press of the **weapon release button** will release a flare.

- **PRS** (Pairs). Each press of the **weapon release button** will release two flares.

Note: Rippled release is not an option for illumination flares.

Release Mode (OSB 10). CCRP is the only release mode available.

DSMS Settings page for Illumination

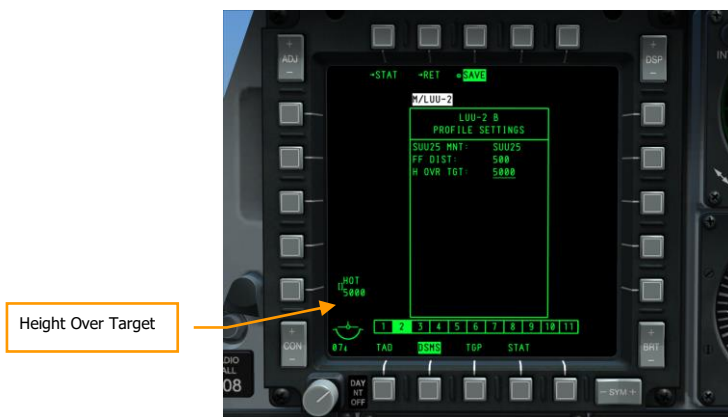

Figure 444. DSMS Profile Settings Page, Illumination Flares

- **Height Over Target (HOT).** This setting allows you to enter the altitude in feet that the flare will be at when at its mid-burn point.

Illumination Flare Use

Delivering an illumination flare is very much like delivering an unguided bomb using CCRP mode as we described earlier. However, the difference being that only Manual Release mode is used.

To release an illumination flare, you will need to do the following:

1. Set the Master Arm switch on the AHCP to ARM.
2. Press the **DMS Left or Right Short** until the desired weapon profile is selected.
3. Press the **Master Mode Control Button** until CCRP is selected (as displayed in the center of the HUD). If you select CCIP, a message on the HUD will instruct you USE CCRP.

4. Set desired target as SPI. There are several ways you can set the target as SPI, which includes:
 - 4.1. Move TDC over target and press **TMS Forward Long** to set as SPI
 - 4.2. Move TGP cursor over target and press **TMS Forward Long** to set as SPI
 - 4.3. Lock target with Maverick and press **TMS Forward Long** to set as SPI
 - 4.4. Set any TAD object as SPI

When the SPI has been set, the Azimuth Steering Line (ASL) on the HUD will indicate heading to SPI (target)

The designated target SPI will also have a SPI locator line extending from it to the TVV, or the TVV will have a SPI locator line extending to the target, depending on if the SPI target is within the HUD field of view.

5. Maneuver the aircraft to align the CCRP Projected Bomb Release Line (PBRL) with the ASL. The CCRP pipper should lay along the ASL.
6. As you near the SPI target, the Time to Release Numeric (TTRN) next to the Solution Cue will indicate the time in seconds until the flare should be released.
7. At about 6 seconds on the TTRN, the Solution Cue will start to fall down the ASL. Maneuver the aircraft so that the Solution Cue falls through the CCRP pipper. When it does, press the weapons release button. Unlike bombing CCRP, you must manually press the **weapon release button** and not simply hold it down for automatic release when solution is achieved.

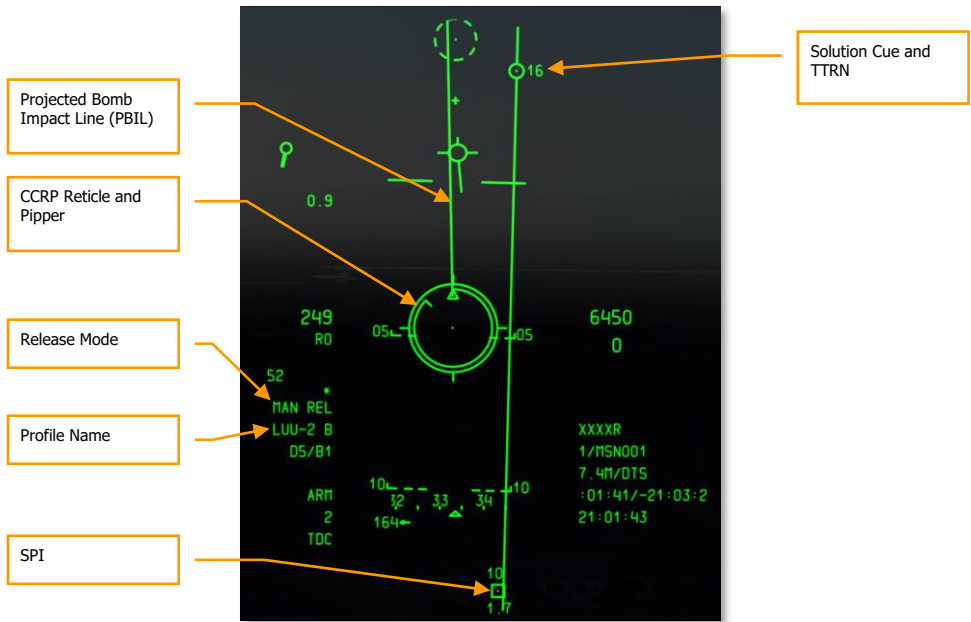

Figure 445. CCRP Illumination Flare HUD

Laser-Guided Bomb Employment

The development of laser guided weapons has dramatically improved the accuracy of weapon guidance and delivery. With the assistance of build-up guidance kits, general GP bombs are turned into laser-guided bombs (LGBs). The kits consist of a computer- control group (CCG), guidance canards attached to the front of the warhead to provide steering commands, and a wing assembly attached to the aft end to provide lift. LGBs are maneuverable, free-fall weapons requiring no electronic interconnect to the aircraft. They have an internal semi-active guidance system that detects laser energy and guides the weapon to a target illuminated by an external laser source. The designator can be located in the delivery aircraft, another aircraft, or a ground source.

All LGB weapons have a CCG, a warhead (bomb body with fuze), and an airfoil group. The computer section transmits directional command signals to the appropriate pair(s) of canards. The guidance canards are attached to each quadrant of the control unit to change the flight path of the weapon. The canard deflections are always full scale (referred to as "bang, bang" guidance).

The LGB flight path is divided into three phases: ballistic, transition, and terminal guidance. During the ballistic phase, the weapon continues on the unguided trajectory established by the flight path of the delivery aircraft at the moment of release. In the ballistic phase, the delivery attitude takes on additional importance, since maneuverability of the UGB is related to the weapon velocity during terminal guidance. Therefore, airspeed lost during the ballistic phase equates to a proportional loss of maneuverability. The transition phase begins at acquisition. During the transition phase, the weapon attempts to align its velocity vector with the line-of-sight vector to the target. During terminal guidance, the UGB attempts to keep its velocity vector aligned with the instantaneous line-of-sight. At the instant alignment occurs, the reflected laser energy centers on the detector and commands the canards to a trail position, which causes the weapon to fly ballistically with gravity biasing towards the target.

AHCP Configuration

Prior to setting up the attack, you will first want to configure your switch settings on the AHCP.



Figure 446. Armament HUD Control Panel

1. Master Arm switch to ARM
2. Laser switch to ARM
3. TGP (Targeting Pod) to ON

Note: You do not need to set a Consent to Release (CR) mode because LGB delivery will default and only use 3/9.

Laser Designate Target

Assuming you will be self-designating the target with your own targeting pod, we will discuss the steps needed to do so:

1. Select the TGP page to be displayed on one of the two MFCD
2. From the default STBY (standby) page, selected the A-G (air-to-ground) page OSB 2

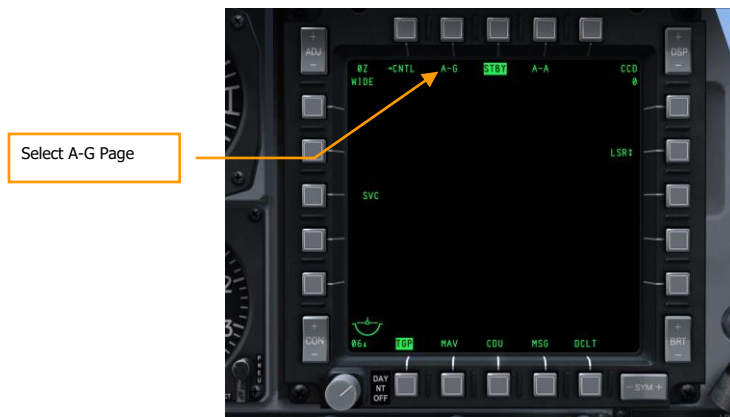

Figure 447. TGP Standby Page

3. From the TGP A-G page, select CNTL by pressing OSB 1

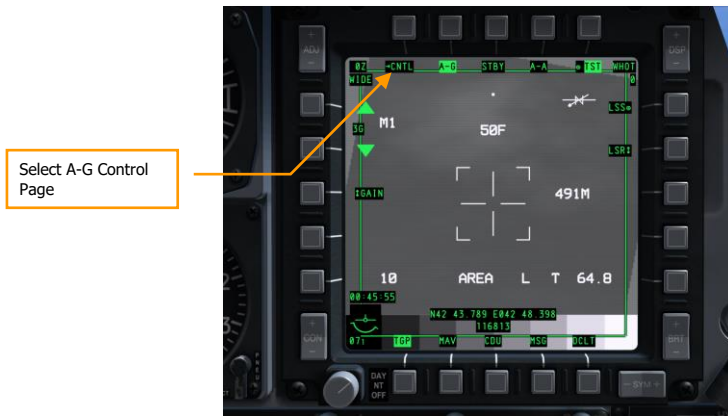

Figure 448. TGP A-G Page

- From the A-G Control (CNTL) page there are three control options you may want to adjust:

Laser Code. Set the laser code that the laser will fire. If self-designating, you will want to make sure this code matches the laser code set for the weapon in the DSMS Inventory Store page. If buddy-lasing for another aircraft, this code will need to match the code the other aircraft is searching for in Laser Spot Search (LSS) mode.

Latch. When the latch option is set to ON, a single press of the laser designate button (nosewheel steering button) will activate the laser and keep it on until you press the button a second time. If Latch is set to OFF, you will need to hold down the nosewheel steering button as long as you want it to fire.

Tip: For best accuracy, start to lase the target 8 seconds before impact.

Yard Stick. This can be cycled between METRIC, USA and OFF. When set to other than OFF, the right-side crosshair arm distance across the ground is displayed as the numeric to the right of the crosshair. It will display meters or feet depending on the selection of Metric or USA.



Figure 449. TGP A-G Control Page

5. After you have adjusted your control settings, press OSB 1 to return (RTN) back to the main A-G page.
6. From the A-G page, slave or slew the crosshairs over the desired target. To slave the TGP to steerpoint, press **China Hat Aft Long**. To slave the TGP to the SPI, press **China Hat Forward Long**. To manually slew TGP line of sight, use the slew control.
7. Once the TGP line of sight is over the target, press **TMS Forward Short** to either stabilize on the location in either AREA or POINT Track Mode. If the target is moving, you will want to use POINT Track Mode.
8. Press TMS Forward Long to set as SPI if not already set as SPI.
9. Confirm Laser Status is set to Laser (L). If not, press **DMS Right Short** until Laser is selected.

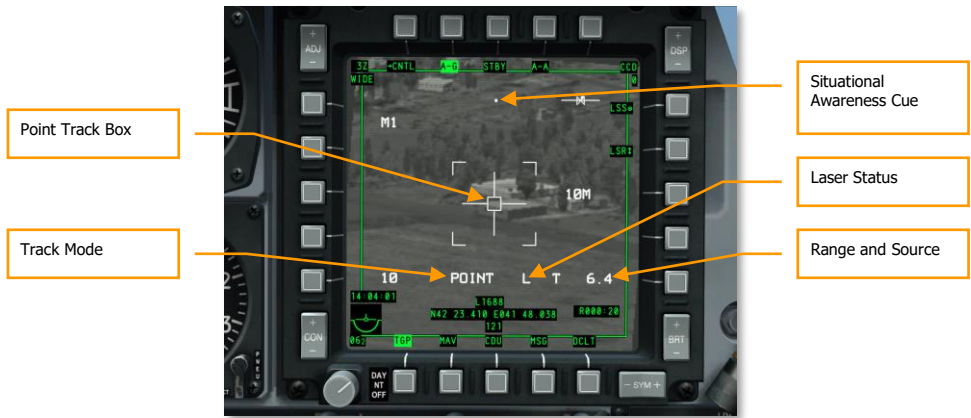

Figure 450. TGP A-G in Point Track

DSMS Laser Guided Bomb Pages

With the target being tracked on the TGP, you will want to check your DSMS settings to make sure all is in order before pressing the attack.

DSMS Status Page for LGB

Stations loaded with either GBU-10 or GBU-12 will contain the following information on the Status page:

- Name of LGB will be listed on the top line
- Laser code will be listed on the bottom line, as set on the DSMS Inventory Page
- To the left or right of the weapon station box is the remaining number of LGB on the station

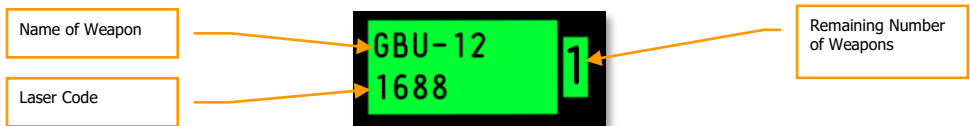

Figure 451. GBU Loaded Station Box

DSMS Status Page for LGB

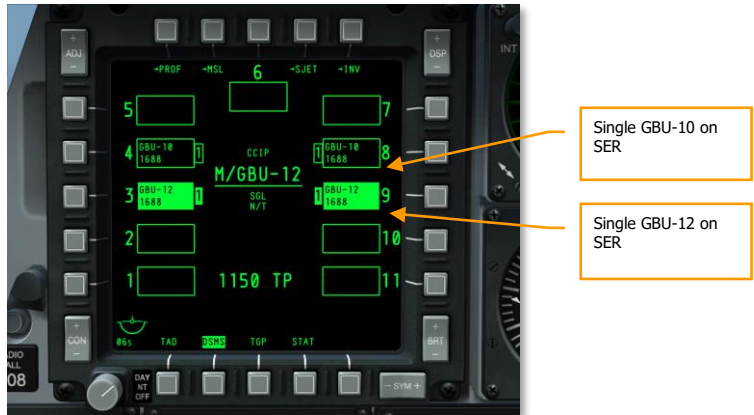

Figure 452. DSMS LGB Status Page

DSMS Control Page for LGB

The DSMS Control page allows you to set the following release options for an LGB:

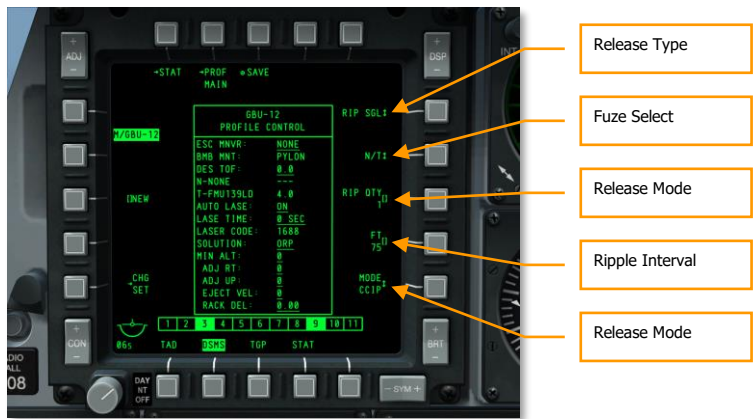

Figure 453. DSMS Profile Control Page, LGB

Release Type (OSB 6). Cycle this option to choose between four release types:

- **SGL** (Singles). Each press of the **weapon release button** will release a bomb.
- **PRS** (Pairs). Each press of the **weapon release button** will release two bombs from opposed wing stations.
- **RIP SGL** (Ripple Singles). Each press of the **weapon release button** will release the number of bombs specified in the RIP QTY (Ripple Quantity) setting.
- **RIP PRS** (Ripple Pairs). Each press of the **weapon release button** will release the number of bombs specified in the RIP PRS setting, in pairs.

Note: When releasing a ripple of bombs, they will land centered around the piper aimpoint.

Fuze Select (OSB 7). Cycle this option between NOSE, TAIL, and N/T (Nose and Tail).

Ripple Quantity (OSB 8). If either RIP SGL or RIP PRS are selected as the Release Type, you may use this to set the number of bombs to release in each ripple.

Release Mode (OSB 10). Select to release bomb in CCIP or CCRP release modes. This setting, along with being assigned to the HUD rotary, will determine if the profile is selected in the CCRP or CCIP rotary. When delivering an LGB, you will set this to CCRP so that it will appear on the CCRP HUD rotary.

DSMS Settings Page for LGB

The DSMS Settings page allows you to configure an LGB delivery as follows:



Figure 454. DSMS Profile Settings Page, LGB

Escape Maneuver (OSB 20). Select type of escape maneuver between:

- NONE
- CLM. Climbing maneuver
- TRN. Turning maneuver
- TLT. Turn Level Turn maneuver

Desired Time of Fall (OSB 19). Set desired time of fall in seconds of the bomb from release to time of impact. The time set will determine the Desired Release Cue (DRC) location on the Projected Bomb Impact Line (PBIL). If you wish to have the bomb drop according to the set TOF, keep the DRC on the target when bombing pipper is over the target.

Minimum Altitude (OSB 18). Used to set the minimum weapon release altitude cues on the HUD. This setting will determine the placement of the Minimum Range Staple (MRS) on the PBIL and the Minimum Range Caret (MRC) within the CCRP HUD reticle.

Lase Time (OSB 17). Set this value in seconds to determine how many seconds before weapon impact that wish the laser to start firing. AUTO LS must be enabled.

Solution (OSB 16). Set desired flight path of bomb between ORP for Optimal Release Point and BAL for Ballistic release point.

Auto Lase (OSB 6). If set to ON, the laser will fire automatically according to the LS TIME (seconds before bomb impact).

Tip: For best accuracy, set this to 8 seconds before impact. If set to 0, the laser will default to firing 4 seconds before impact.

Horizontal Offset (OSB 7). Set horizontal offset of weapon between -15 and +15 mils.

Vertical Offset (OSB 8). Set vertical offset of weapon between -15 and +15 mils.

Weapon Eject Velocity (OSB 9). Set ejection velocity of pod between -10 and +30 feet per second.

Bomb Rack Delay (OSB 10). Set bomb rack delay between -0.40 and +0.40.

Laser Guided Bomb Use

With the AHCP, TGP and DSMS set up correctly, you will follow these steps to attack the TGP-designated target with an LGB.

1. Set HUD to SOI and press the **DMS Left or Right Short** on the control stick left or right to select the desired LGB profile.
2. Press the Master Mode Control Button until CCRP is selected. Master mode name is displayed in the center of the HUD.
3. Both the Azimuth Steering Line (ASL) and the SPI will indicate the proper heading to reach the target.
4. Maneuver the aircraft to align the PBIL on top of the ASL.
5. As range to target decreases, the Time to Release Numeric (TTRN) will appear next to the Solution Cue and display the time in seconds until bomb release.

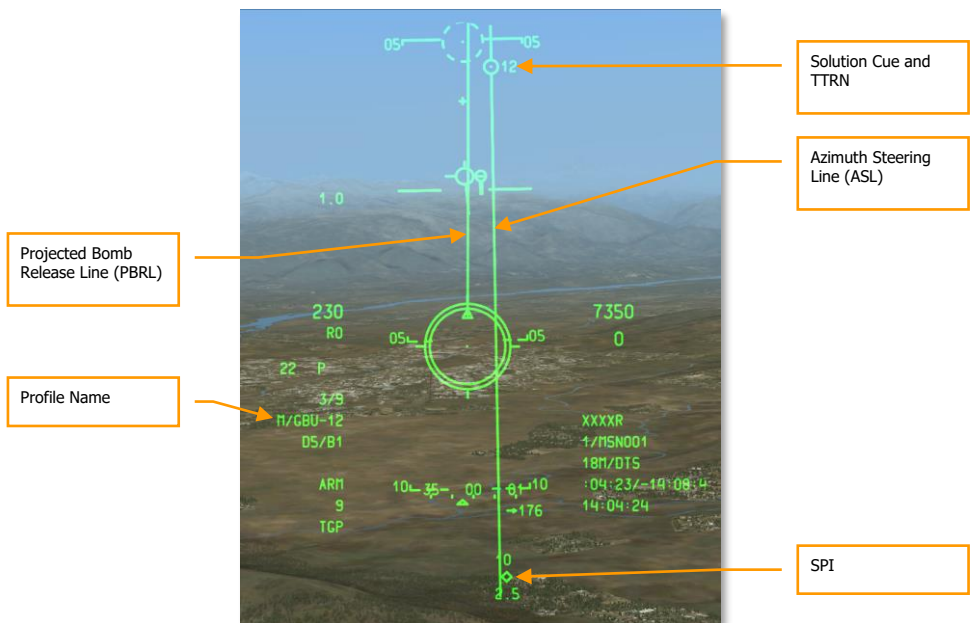

Figure 455. CCRP LGB HUD, Out of Solution

When approximately 6 seconds from release, the Solution Cue and TTRN will drop down the ASL. When this starts, hold down the **weapon release button** until the solution cue passes through the CCRP Bombing Reticle. When it passes through, the bomb(s) will be released.

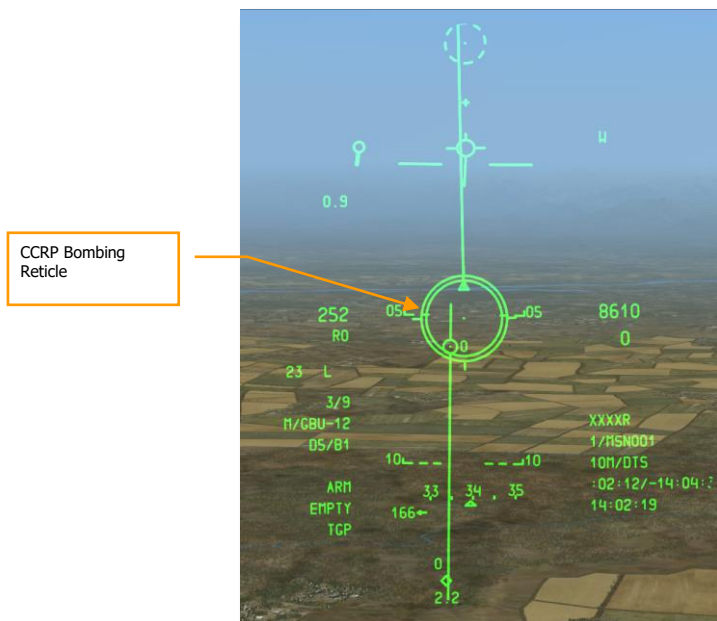

Figure 456. CCRP LGB HUD, In Solution

- With the bomb released, release the **weapon release button** and press the nosewheel steering button to fire the laser if AUTO LASE is not set to ON. If the laser is firing, the "L" laser status on the left side of the HUD will flash.

To the left of the laser status indication is the countdown timer of bomb time to impact.

As the bomb guides to target, ensure that the targeting pod has an unobstructed line of sight to the target. Avoid any masking of the target by the aircraft. If there is masking, the M indication will be visible on the HUD. A high altitude and keeping the targeting pod on the same side as the target will reduced masking probability. Use the situational awareness cue on the TGP display to monitor this.

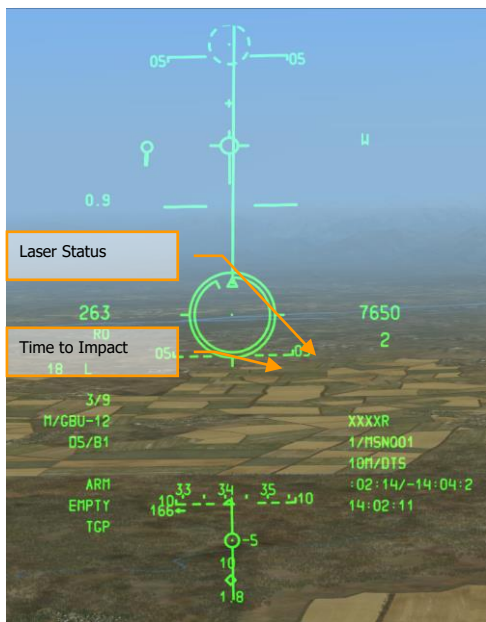

Figure 457. CCRP LGB HUD, Post-Release

Note: To improve accuracy, it's recommended that you deliver these bombs from above 15,000 feet AGL and delay lasing the target until 8 seconds before impact.

IAM Bomb Employment

DSMS IAM Bomb Pages

Due to the nature of the guidance system of these weapons, they directly tie into data exported from the EGI system. Additionally, because they are only mounted on 1760 smart stations, the station itself needs to be under power as determined on the DSMS STAT page.

Each of the six 1760 weapon stations has the following data in the weapon station boxes:

- The top line lists the name of the IAM
- The bottom line lists the status of the IAM
- **RDY**. Weapon is ready to be employed
- **ALN GRDY**. Weapon is aligned but aircraft is on ground
- **OFF**. Weapon station is currently powered off

To the left or right of the box will be the number of IAMs on the station



Figure 458. GBU-38 Station Box Loading, Ready



Figure 459. GBU-38 Station Box Loading, Aircraft on Ground

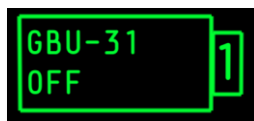

Figure 460. GBU-31 Station Box Loading, Station OFF

DSMS GPS/INS-Bomb Status Page

Below is an example of the DSMS Status page with IAMs loaded on all six 1760 smart stations.



Figure 461. DSMS Status Page

DSMS GPS/INS-Bomb Control Page

The DSMS Control page provides the following options for an IAM.

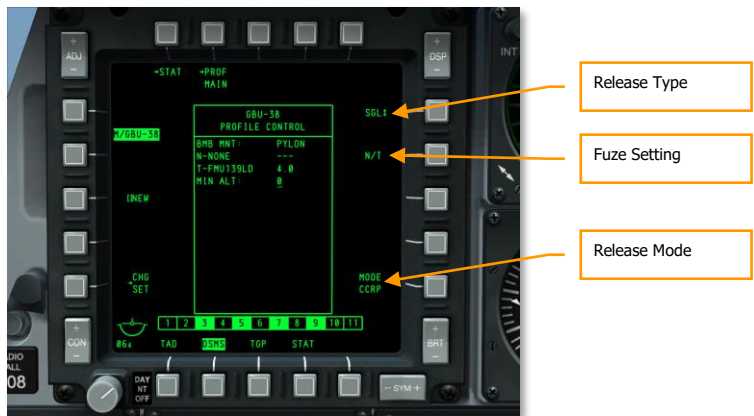

Figure 462. DSMS Profile Control Page, IAM

Release Type (OSB 6). Cycle this option to choose between two release types:

- **SGL** (Singles). Each press of the **weapon release button** will release a bomb.
- **PRS** (Pairs). Each press of the **weapon release button** will release two bombs from opposed wing stations.

Fuze Select (OSB 7). Cycle this option between NOSE, TAIL, and N/T (Nose and Tail).

Release Mode (OSB 10). Select to release an IAM in CCIP or CCRP release modes. This setting, along with being assigned to the HUD rotary, will determine if the profile is selected in the CCRP or CCIP rotary.

DSMS GPS/INS-Weapon Settings Page

The DSMS Settings page provides the following options for an IAM.

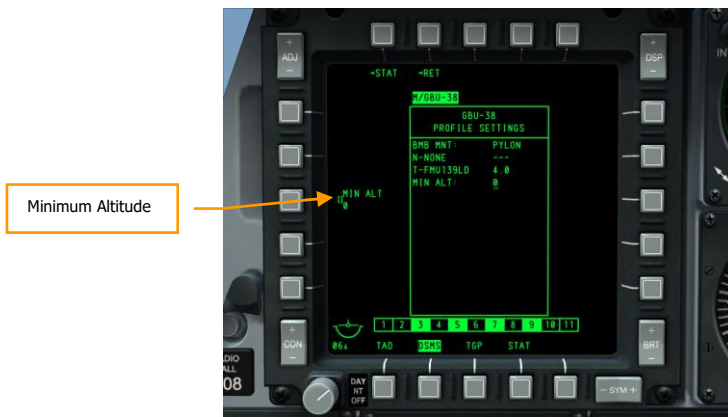

Figure 463. DSMS Profile Settings Page, IAM

Minimum Altitude (OSB 18). Used to set the minimum weapon release altitude cues on the HUD. This setting will determine the placement of the Minimum Range Staple (MRS) on the PBIL.

IAM Bomb Use

Using an IAM bomb is simplicity in itself. To drop an IAM bomb on a SPI designated target, follow these steps:

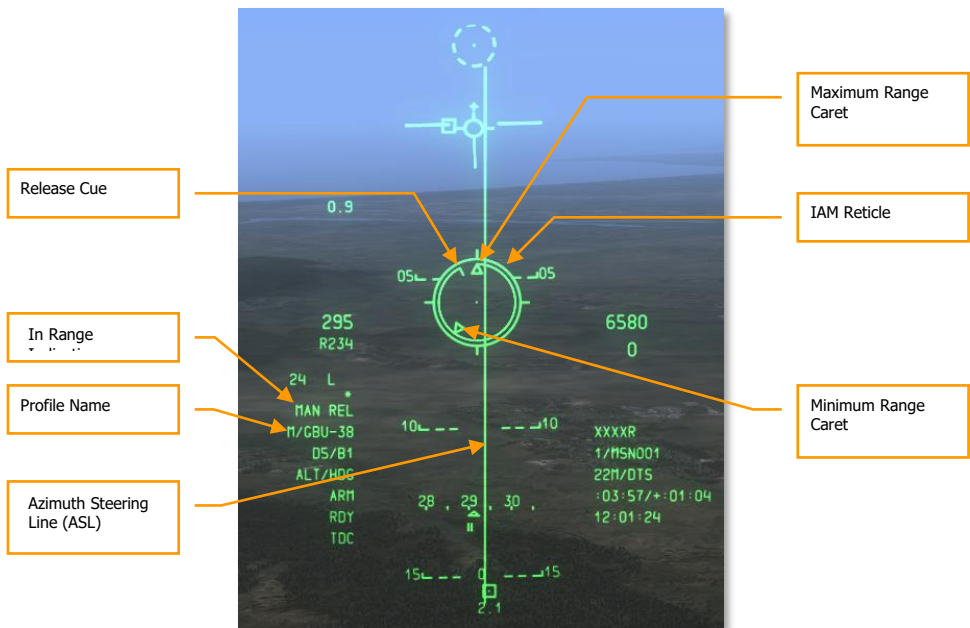

Figure 464. CCRP IAM HUD

1. Set the Master Arm switch on the AHCP to ARM
2. Press the **DMS Left or Right Short** on the control stick until the desired IAM-weapon profile is selected
3. Press the **Master Mode Control Button** until CCRP is selected (as displayed in the center of the HUD).
4. Set desired location/target as SPI. There are several ways you can set the target as SPI, which includes:
5. Move TDC over target and press **TMS Forward Long** to set as SPI

6. Move TGP cursor over target and press **TMS Forward Long** to set as SPI
7. Lock target with Maverick and press **TMS Forward Long** to set as SPI
8. Set any TAD object as SPI
9. When the SPI has been set, the Azimuth Steering Line (ASL) on the HUD will indicate heading to SPI (target).

The designated target SPI will also have a SPI locator line extending from it to the TVV, or the TVV will have a SPI locator line extending to the target, depending on if the SPI target is within the HUD field of view.

10. Maneuver the aircraft to align the IAM Reticle on the ASL.

The Release Cue will move from the 12 o'clock of the IAM Reticle counterclockwise and when the Release Cue is between the Maximum Range Caret and the Minimum Range Caret, MAN REL will appear in the In Range Indication field.

11. When in range, you can HOLD DOWN the **Weapon Release button** to drop the weapon. Do not simply tap the **weapon release button** or this could result in a hung store.

GBU-54A Laser-JDAM (LJDAM)

A hybrid of a GBU-38 JDAM and a GBU-12 laser-guided bomb is the GBU-54/A LJDAM. This weapon can act in both INS/GPS and laser-guidance modes, this allowing it launch-and-leave and engaging through cloud/dust as an INS/GPS weapon, and with the precision and ability to engage moving targets that laser-guidance provides.

The GBU-54/A is a strap-on guidance kit for a standard Mk-82 general purpose bomb. The guidance kit includes both the GPS/INS guidance kit and a laser seeker / target detection guidance kit that allows the bomb to guide on moving targets.

The GBU-54/A can be loaded on any station that a GBU-38 can be loaded on (any 1760 smart station).

DSMS

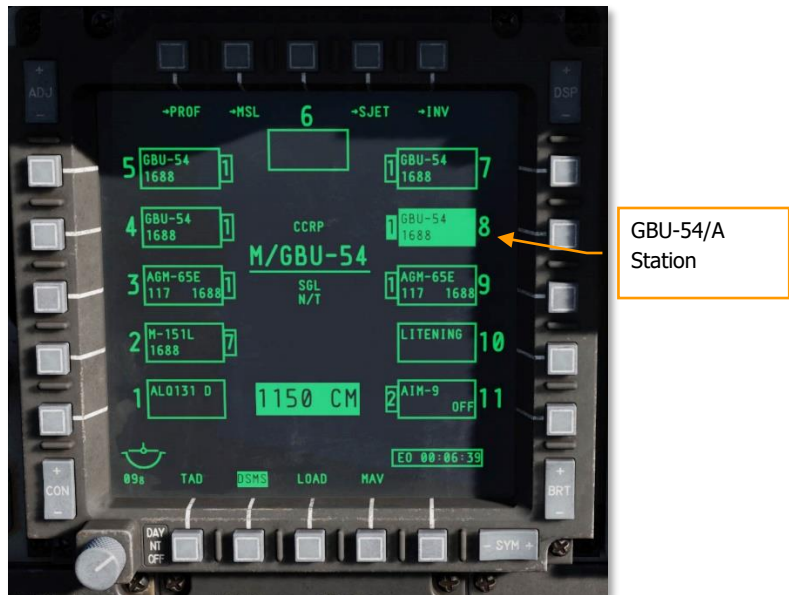

Figure 465. GBU-54/A Status Page

On the DSMS page station boxes, each GBU-54/A station consists of:

- GBU-54 in top left of the box
- Alternating between the INS/GPS alignment status and the selected laser code in the bottom left of box (XXXX)

As with other munitions, the station can be manually selected or selected via its weapon profile. In the example above, the weapon has been selected manually.

Selection of the GBU-54/A Inventory page is accessed through the Inventory → GBU-54/A station → GBU → GBU-54



Figure 466. GBU-54/A INV Page

On the Inventory page, it will be the same as the standard LGB Inventory page but the SERIES selection at OSB 16 is removed. As with other LGBs, the laser code will be entered here at OSB 12.

TAIL fuze options are only:

- FMU152
- FMU139

The NOSE fuze option is only:

- DSU38

If electing to use laser-guidance, the laser code may also be entered from the page. The default laser PRF code is 1688, but by entering a four-digit octal code on the UFC scratch pad and then pressing the LSR CODE OSB, a new code may be entered.

HUD

The HUD for the GBU-54/A is the same HUD for all other IAM weapons:

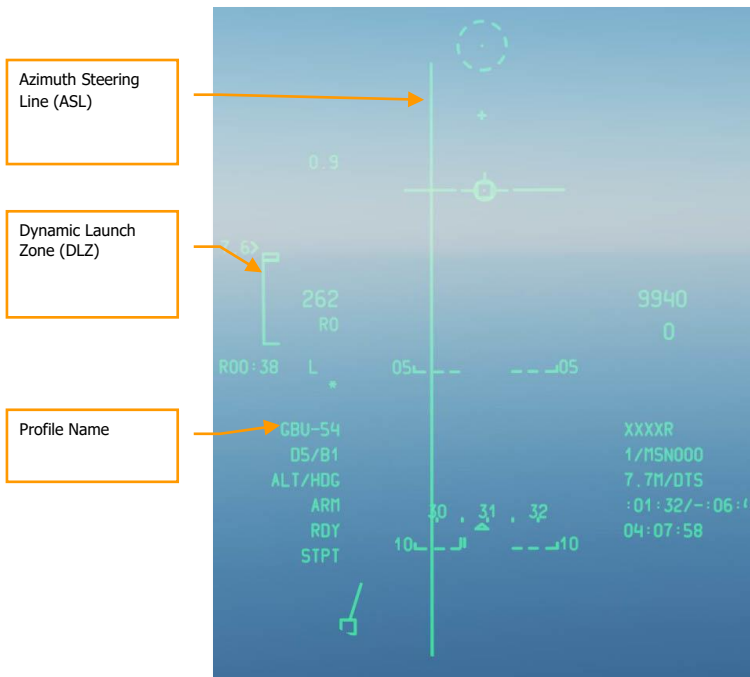

Figure 467. GBU-54/A HUD

Dynamic Launch Zone (DLZ)

- Maximum range
- Optimal range
- Minimum range
- Current range

Between the minimum and optimal range, the staple is closed to form a box. The current range is represented by a caret that moves along the DLZ range indications. Below the DLZ staple is a digital indication of target range.

Profile Name. This can either be either the HOTAS selected profile or the M/ (manual) profile name.

Azimuth Steering Line (ASL). The vertical ASL line corresponds to steering of the SPI.

Engagement

Upon creating the SPI at the target location, the pilot would slave the targeting pod to the SPI and laser-designate the target (static or moving) in point track or area mode. When the bomb is released, it will use GPS/INS guidance to reach the target location and the laser designation will continually update GPS/INS guidance to allow the weapon to change guidance while in flight based on the designated location. If laser-designation is lost, the weapon will continue to guide on the last designated location using INS/GPS-guidance.

AGM-65 E/O Maverick Employment

DSMS and MFCD Maverick Pages

When using the Maverick, you will use both the Maverick (MAV) MFCD page and the DSMS pages. Once the weapon has been configured, you will also use the HUD to assist in aiming. There are no IFFCC Test settings needed for the Maverick.

Maverick Page

All versions of the Maverick use an internal gyro to stabilize the seeker and missile before and during attack. Prior to engaging with a Maverick, you will need to align the gyros of all Mavericks loaded on the aircraft. To do so:

Select the MAV display on either MFCD. The page will initially indicate OFF, but by pressing the EO OSB 6, you will start the gyro alignment process for all Mavericks loaded. The alignment process takes 3 minutes.



Figure 468. MFCD Maverick Page, Power Off

The EO Timer in the bottom right corner of the display shows the time since the Mavericks were turned on.



Figure 469. MFC D Maverick Page, Alignment

DSMS Maverick Status Page

On the DSMS Status page, Mavericks can be loaded only on stations 3 and 9. Mavericks loaded on those stations will have weapon station boxes with this possible information:

Top line lists the name of the Maverick version

The bottom line will list the type of launcher (88 for LAU-88 or 117 for LAU-117) on one side and the Maverick status on the other. Possible Maverick states are:

- **OFF.** Maverick power is set to OFF on the Maverick MFC D page.
- **ALN.** The Maverick is undergoing the 3-minute alignment.
- **RDY.** The Maverick station is currently active.
- **STBY.** The Maverick station is in standby mode but is aligned.
- **FLAPS.** Flaps are down and must be raised.



Figure 470. Maverick Station Box Loading, Power Off



Figure 471. Maverick Station Box Loading, In Alignment



Figure 472. Maverick Station Box Loading, Aligned but not Selected

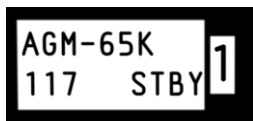

Figure 473. Maverick Station Box Loading, Selected

Note: The active Maverick station is colored white.



Figure 474. DSMS Status Page

Maverick Use

After the Mavericks are aligned, you can display video from the Maverick seeker on an MFCD and engage a target with the following steps:

1. On the AHCP, set the Master Arm switch to ARM
2. From one of the MFCD, select the MAV OSB

Maverick video will now be displayed on the selected MFCD in either Electro-optical or Imaging Infrared

Maverick in Sensor and Weapon Modes



Figure 475. Maverick in Sensor Mode

Without a Maverick profile selected, the Maverick will be in SENSOR mode as indicated on the left side of the display. This indicates that you can use the sensor normally, but you cannot launch a weapon.

To put the Maverick in Weapon mode, select a Maverick profile by setting HUD as SOI and then pressing **DMS Left** or **Right Short** to cycle through HUD rotary profiles.

Maverick in Centroid Tracking Mode



Figure 476. Maverick in Weapon Mode, No Track

With the Maverick in Weapon mode, SENSOR on the left side of the display is replaced with the Dynamic Launch Zone (DLZ). The caret on the right side of the DLZ indicates line of sight range from the aircraft to the ground point under the tracking gate. The top and bottom of the DLZ staple indicate the maximum and minimum range of the Maverick. The number at the bottom of the DLZ indicates the projected flight time of the missile.

Use the slew switch or Slave All to SPI command (**China Hat Forward Long**) to move the tracking gate over the desired target.

You can change your field of view by pressing **China Hat Forward Short** on the throttle.

Slew the tracking gate over the target and release the slew control. When you release, the Maverick will attempt to lock onto the center of mass of a target it detects inside the tracking gate. If it cannot lock on to a target, after a few seconds, the seeker will go into Break Lock mode and the crosshairs will expand out to the edges of the display. To try to lock again, slew the tracking gate back on to the target and release the slew control. Depending on the range to target and the size of the target, this may take a few tries.

If the seeker is slewed from a stabilized position (boresight or slaved to SPI), it will no longer be stabilized once slewed off.

In addition to the slew and release method of locking a target, you may also keep the tracking gate in boresight and fly to place the tracking gate over the target and then press **TMS Forward Short** to initiate a lock. You can also do this when the tracking gate has been moved over a target while in a slave state (such as slaving your Maverick to the SPI).



Figure 477. Maverick in Break Lock Mode

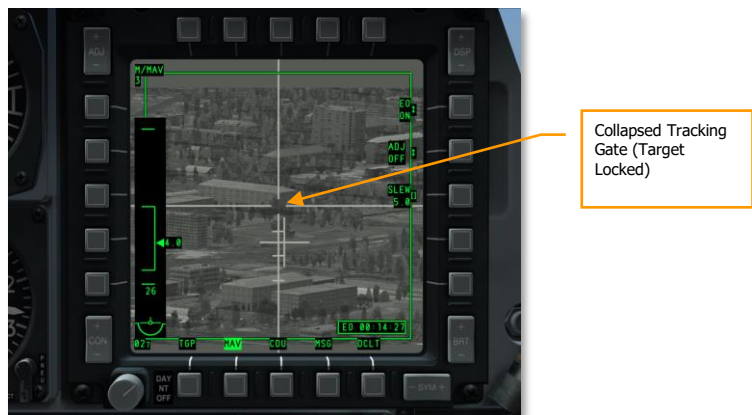

Figure 478. Maverick in Weapon Mode, Tracking

When the Maverick has locked on to a target, the Pointing Cross that represents the pointing angle of the Maverick in relation to the aircraft's longitudinal axis will flash.

At this point you can hold down the **weapon release button** to launch the missile.

If you have fired a Maverick from a LAU-88 launcher, the next Maverick on the launcher will automatically be selected and slewed to the last Maverick lock location. This is termed a "Quick Draw".

If, however, you wish to select a Maverick from another station, you must cycle your profile using the HUD rotary by pressing **DMS Left or Right Short**.

If you wish to re-cage the Maverick seeker to its boresight position or the seeker has reached its gimbal limits, you can re-cage the seeker to boresight by pressing **China Hat Aft Short**.

Using a Maverick in centroid track is best for moving vehicles or small, stationary targets.

Maverick in Force Correlate Tracking Mode

If you need to attack a specific part of a large object (such as a particular window in an office building), you can use force correlate mode with AGM/TGM-65H, AGM/TGM-65G, AGM-65K, and CATM-65K. This mode allows the seeker to create a basic picture of the scene and home in on one specified area of that scene.

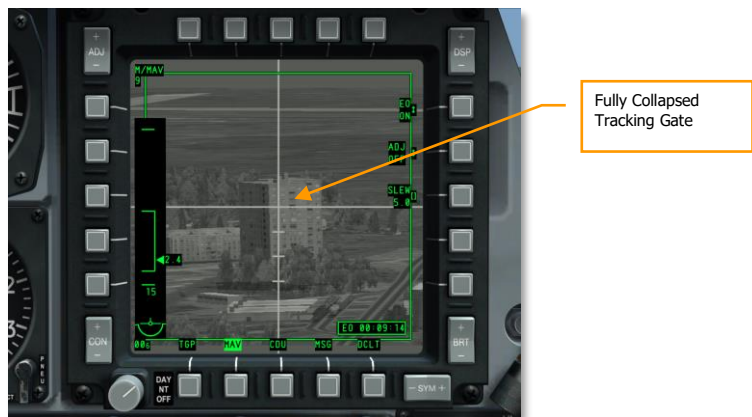

Figure 479. Maverick Force Correlate Track

To use the Maverick in force correlate mode:

1. Place the **Boat Switch** in the center position.
2. Slew the tracking gate near the intended target.
3. Ground stabilize the Maverick by pressing **TMS Aft Short**.
4. Slew the tracking gate over the target and the tracking gate will fully collapse. The Pointing Cross will go steady.
5. You can now launch the Maverick by holding down the **weapon release button**.

Maverick HUD Use

Although you can complete an entire Maverick engagement from just looking at the MFCDs, the HUD provides much of the same information but allows you to keep your eyes out of the cockpit. Important Maverick HUD information includes:

The Maverick wagon wheel symbol displays the line-of-sight point that corresponds to the Maverick tracking gate on the MFCD MAV page. Below the symbol is the range to target. When the Maverick is caged, it will automatically return to its boresight position. You can manually set this position by:

1. Set MAV to SENSOR mode
2. Lock a ground or air target with the Maverick
3. Set the Boat Switch to the center (AUTO) position. When you do so, SEEKER BORESIGHT will display on the MAV page
4. Place the Depressible Pipper over the locked target and press **TMS Forward Short**. When you do so, the SEEKER BORESIGHT message will switch to reverse video.
5. Move the Boat Switch out of the center (AUTO) position.

The information of the Maverick Page DLZ is duplicated on the HUD.

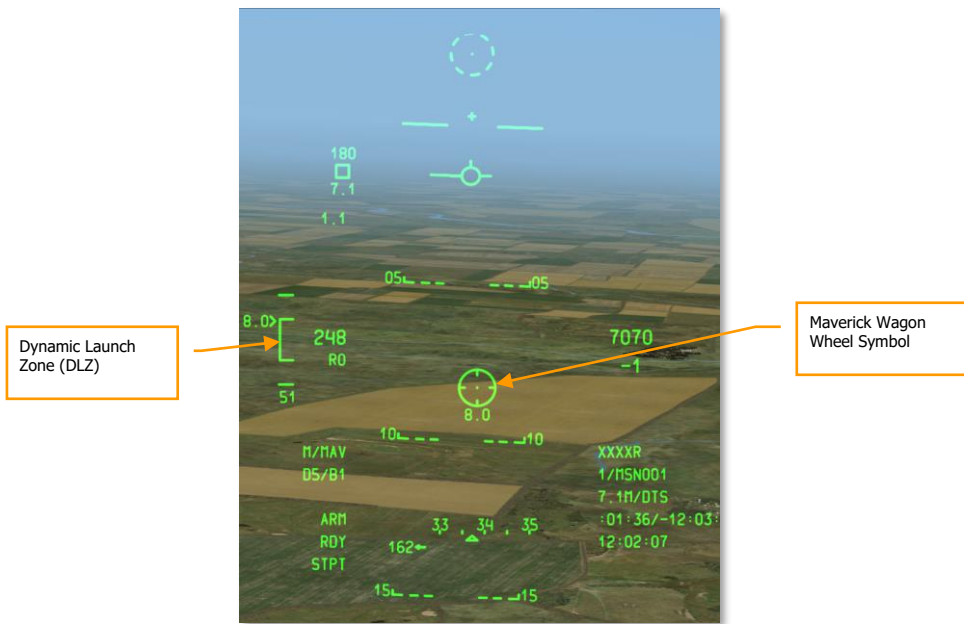

Figure 480. CCIP Maverick Mode HUD

AGM-65L Laser-Guided Maverick

Unlike the other EO and IR versions of the Maverick, the AGM-65L model uses laser energy to guide on target. This laser energy can be either from the aircraft's own LITENING pod or from an external designator like a FAC or other aircraft. However, to detect the designation, the AGM-65L needs to have its laser code set to the same PRF code as the designator.

The L model has the same warhead and motor as a G model. Like an AGM-65G, it can only be mounted on the LAU-117 launcher on stations 3 and 9. It is selected in DSMS as any other Maverick type.

To include the AGM-65E, we will include a new DSMS/INVENTORY/STORE page and a new weapon video page on the selected MFCD.

AGM-65L DSMS Status Page



Figure 481. AGM-65L Status Page

On the DSMS Status page, each AGM-65L station cycles between the alignment status code and its laser code (default 1688).

DSMS INVENTORY Page

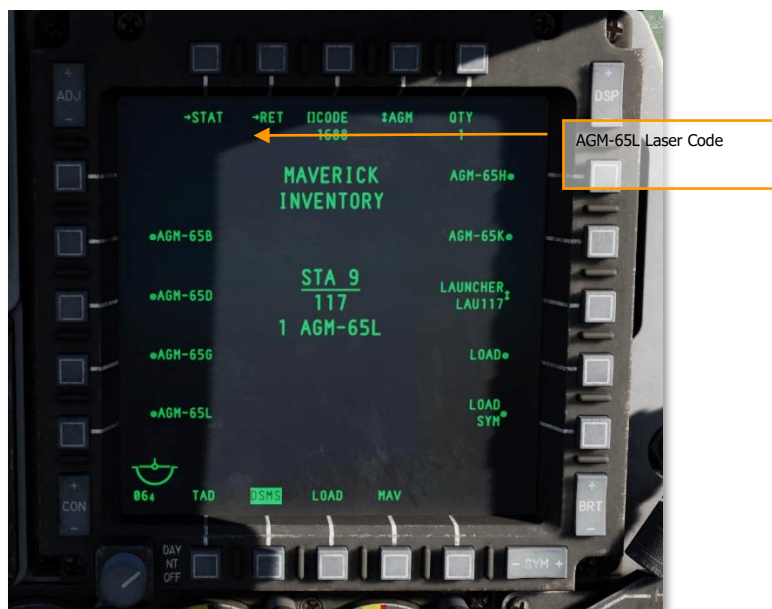

Figure 482. AGM-65L INV Page

From the DSMS/Inventory page, the laser Pulse Repetition Frequency (PRF) of the laser code the AGM-65L is programmed to detected and track can be entered. To set the AGM-65L laser code using the DSMS/Inventory page:

1. Enter the four-digit, octal code on the UFC scratchpad.
2. Press the data entry option select button above the CODE selection.

Laser-Maverick Video

The AGM-65L has a free gyro assembly with a 30° field of view (up, down, left, and right). The tracker has a maximum 10° per second slew rate. The gyro takes three minutes to align, as with the other Maverick versions.

Unlike the EO and IR versions of Maverick, the laser version displays a synthetic view along the longitudinal axis of the missile and only shows indications of receiving or not receiving laser energy.

READY Mode

When the AGM-65L is initially selected and is in "Ready" mode, the active MFCD will appear as follows with the following indications:

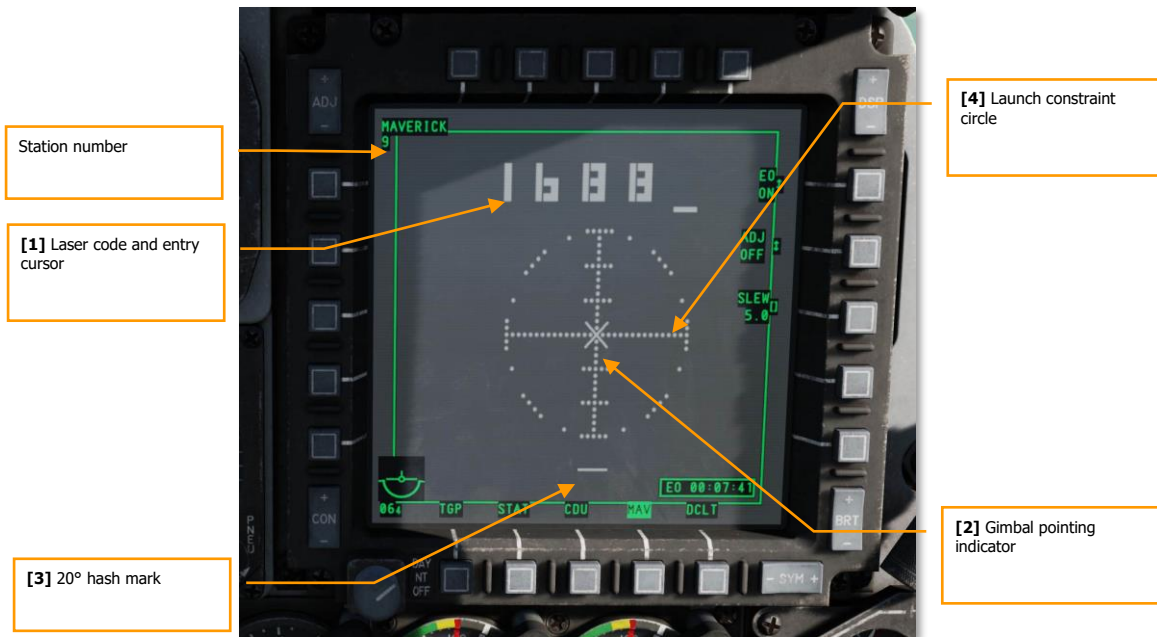

Figure 483. AGM-65L Video Target Laser Search Page

1. **Laser code and cursor.** The laser PRF code consists of four digits and it can be inputted using the Boat switch on the throttle (in addition to DSMS/Inventory). The default PRF code is "1 6 8 8". The flashing horizontal line indicates the current cursor position. To use the Boat switch to enter a PRF code:
 1. Move the switch forward to set the cursor under the first digit (furthest left)
 2. Move the switch aft to cycle digits between 1 and 7
 3. Move the switch to center to stop digit cycle
 4. Move the switch forward again to move the cursor to the next digit
 5. Move the switch aft to cycle digits between 1 and 7
 6. Repeat

Once a PRF code has been set, the cursor will stop flashing.

After inputting the four-digit PRF code, the user may move the cursor to the fifth position (right most) and set countermeasure mode on (when the cursor is in this position, it will not flash). This is done by cycling the Boat switch aft. When active, a "C" will be displayed.

2. **Gimbal Pointing Indicator (GPI).** This "X" mark indicates the pointing center of the scan. Using the slew control, the user may slew the GPI up or down to scan at a depressed angle. Using a China Hat aft command, the user may reset the GPI back to center.
3. **20° hash mark.** This horizontal line at the bottom of the display indicates 20° down from the center point.
4. **Launch constraint circle.** This is a 15° circle that indicates that maximum off boresight launch limit.

ACTIVATE Mode

Once a PRF code has been entered, you can uncage the missile by pressing TMS forward. This is termed the "Activate" mode. Upon doing so, the seeker will begin searching for a laser designation matching that of the entered PRF code along its boresight line of sight (81 mils). If it detects laser energy along this LOS at the set PRF, the GPI will start to flash. If the reflected energy is strong enough, the flashing GPI will automatically become a solid, white square that indicates a valid lock.

SCAN Mode

If a valid PRF return is not detected (non-flashing GPI), you may enter "Slew" mode. This is done by moving and releasing the slew switch. Upon doing so, the GPI will automatically scan left and right from center ± 22 degrees. Using the slew switch, the user can also set the depression angle that the scan will take place from.

When in Slew mode, the GPI will flash if the correct PRF code is detected. If the energy is strong enough, the GPI "X" will turn into a square and the seeker will automatically lock onto the return.

SLAVE Mode

In addition to manually aligning the seeker field of view with the target, you may also Slave the seeker to a SPI or TGP location within 30° of the seeker's boresight. This is done with the slave to SPI or slave to TGP HOTAS command. When commanded, the seeker will perform an auto-track scan of the designated area and attempt to find the coded PRF. If detected (flashing GPI "X"), the user will need to manually designate with a TMS forward short HOTAS command.

When slaved from another sensor, an "S" will be displayed on the right side of the display.



Figure 484. AGM-65L Video Target Laser Track Page

Advanced Precision Kill Weapon System (APKWS)

The Advanced Precision Kill Weapons System (APKWS) II is a laser guidance kit developed for the Hydra 70 unguided aerial rocket. The APKWS II guidance kit consists of two forward-facing laser receivers mounted on steerable canards, turning the rocket into a precision-guided munition (PGM).

APKWS II is about one-third the cost and weight of the GBU-12 500-lb. laser-guided bomb. Like the GBU-12 and other laser-guided weapons, APKWS II can be guided by the launching aircraft's onboard laser designator, or using a laser emitted from another aircraft or ground personnel. APKWS II also takes about a quarter the time of the GBU-12 to load and unload, and its low-yield warhead creates significantly reduced risk of collateral damage.

The contract to develop and manufacture APKWS II was won by a partnership of BAE, Northrop Grumman, and General Dynamics. Initial operational capability (IOC) was achieved in March of 2012, and its first combat use was in early 2012, by US Marines in Afghanistan.

APKWS II is mounted at the rocket mid-body. The two laser receivers work together as a single distributed-aperture semi-active laser seeker (DASALS). Using laser receivers on the APKWS's own canards simplifies installations, which does not require modification of the rocket's nosecone. BAE describes the installation as plug and play and employment as point and shoot. The APKWS does not require any additional onboard equipment or avionics to be installed on the launching aircraft.

APKWS II has an employment range of 0.5 to 2.5 nautical miles, and a guidance range of 7.5 NM. The LAU-68 F/A launch tube was lengthened to accommodate the additional 18.5 inches of length added by the guidance unit. The guidance unit adds nine pounds to the rocket's overall weight.

Along with the Hydra 70, APKWS II can be used on the Belgian Forges de Zeebrugge (FZ) rocket without modification. The first fixed-wing aircraft to load APKWS II was the A-10 in 2013. F-16s and A-10s both employed APKWS II during the Battle of Mosul in 2016.

DSMS

On the DSMS Status page station boxes, each APKWS station consists of:

- Warhead type of M-151L high explosive warhead or M-282L penetrator warhead in top left of the box
- Alternating between APKWS and the selected laser code in the bottom left of box (XXXX)

As with other munitions, the station can be manually selected or selected via its weapon profile. In the example above, the weapon has been selected manually.

Selection of the APKWS Inventory page is accessed through the Inventory → APKWS station → Rockets.

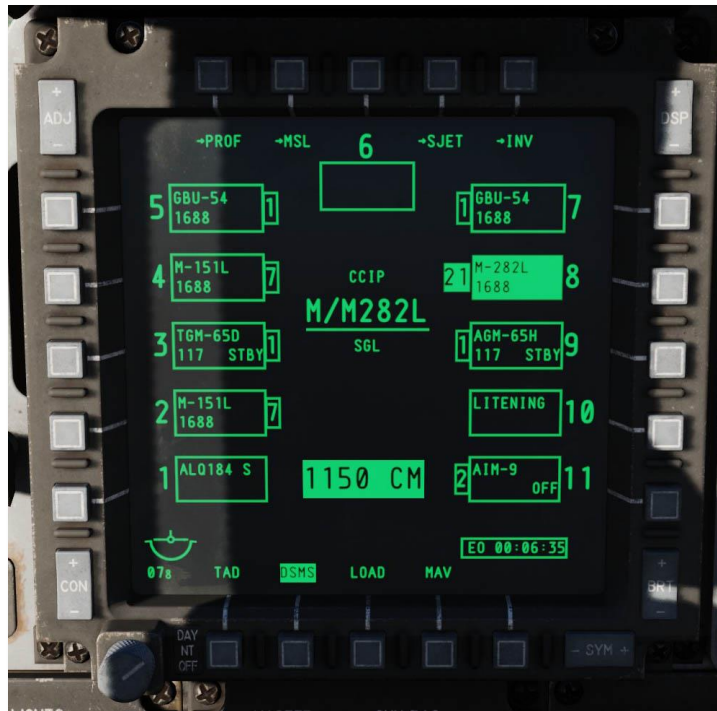

Figure 485. APKWS Status Page

On the Inventory page for the APKWS, the following options are available:

- Rocket pod setting of single or double launch
- Manual laser code entry.
- Mount type of a TER or single pylon.
- Motor type of MK66 or Mk40.

- Launcher type of LAU-131 or LAU-68 (LAU-131 for the APKWS)

If electing to use laser-guidance, the laser code may also be entered from the page. The default laser PRF code is 1688, but by entering a four-digit octal code on the UFC scratch pad and then pressing the LSR CODE OSB, a new code may be entered.



Figure 486. APKWS INV Page

HUD

The HUD for the APKWS is the same as unguided rockets:

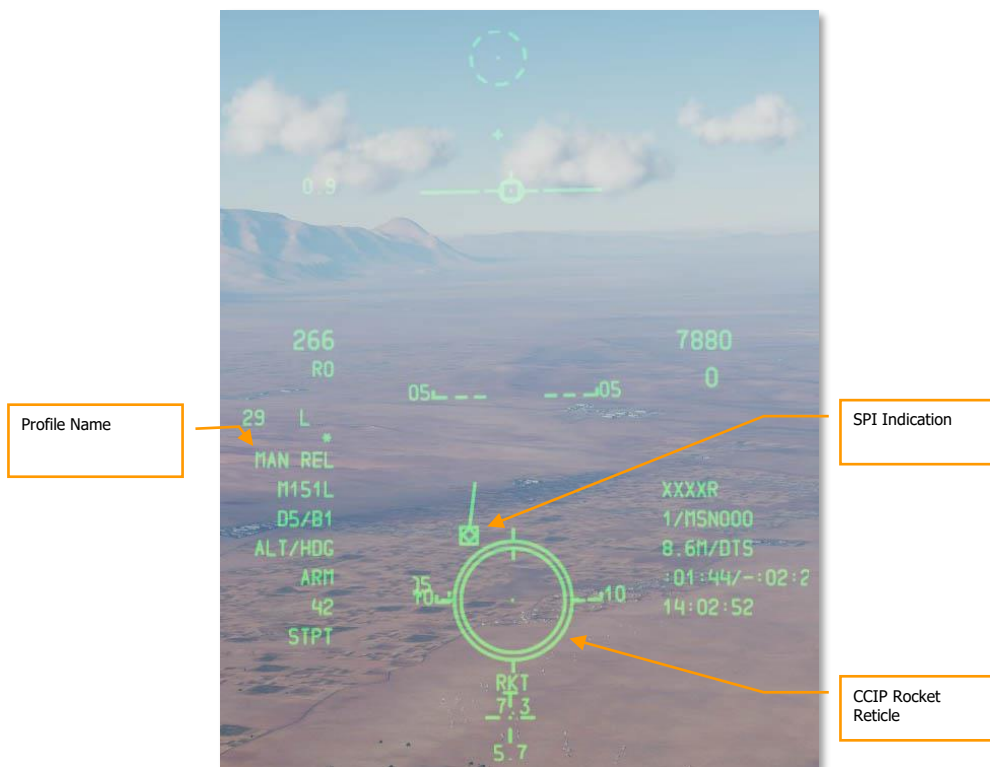

Figure 487. APKWS HUD

CCIP Rocket Reticle. This is the same reticle for unguided rockets with a 12,000-foot reticle.

Profile Name. This can either be either the HOTAS selected profile or the "M/" (manual) profile name.

Senor Point of Interest. If self-designating, a SPI will need to be created at where the laser designation is directed.

Engagement

The APKWS is a laser-guided weapon system that must be supported with a laser designation from your targeting pod or an offboard designation source like a JTAC or other aircraft. Upon selecting AG mode, the APKWS weapon profile, and having the target laser-designated, you must ensure that the APKWS laser-code matches the designation laser code.

At around 6 nm from the target (based on targeting pod range indication), fly to place the CCIP rocket reticle over the target area and activate the laser designation (assuming use of your targeting pod). At 5.0 to 5.5 nm, launch the rocket and maintain laser-designation of the target until the rocket impacts. Be careful to avoid masking of the targeting pod laser to the target.

Air-to-Air Employment

DSMS Air-to-Air Status Page

Stations loaded with AIM-9M or CATM-9M have the following information in the Status page weapon station boxes:

The top line lists the name of the missile. If all missiles have been expended on the station, DRA (Dual Rail Adapter) is displayed.

The bottom line indicates RDY (ready) if Air-to-Air mode is selected, and that station is selected; COOL is displayed when in Air-to-Air mode, but the station is not currently selected.



Figure 488. AIM-9 Station Box Loading

In the lower center of the DSMS Status display is the number of 30 mm cannon rounds remaining and the type of cannon rounds loaded.

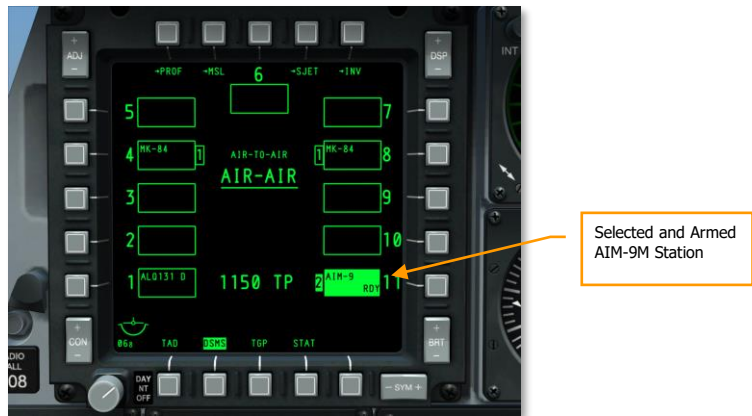

Figure 489. DSMS Status Page

Using the Targeting Pod for Air-to-Air

In addition to using your eyes to spot and track aerial targets, you can also use the targeting pod when in A-A (Air-to-Air Mode). To use the targeting pod to target aerial units, you will need to do the following:

1. Set the TGP switch on the AHCP to the ON position.
2. Select the TGP OSB from one of the MFCs to display the TGP page.
3. Once the TGP has cooled down and is displaying the default STBY (standby) page, press the A-A OSB 4.

With the TGP in A-A mode, you can adjust the Field of View between Narrow and Wide by pressing **China Hat Forward Short** on the throttle. The field of view setting is indicated by the corner makers.

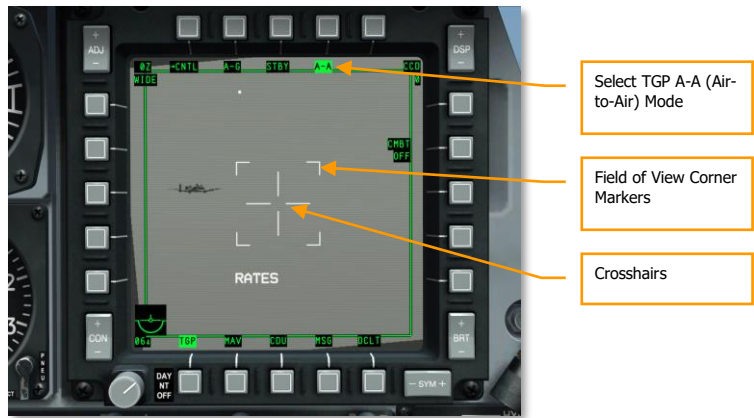

Figure 490. TGP A-A Default

4. Maneuver the aircraft to place the aerial target within the crosshairs.

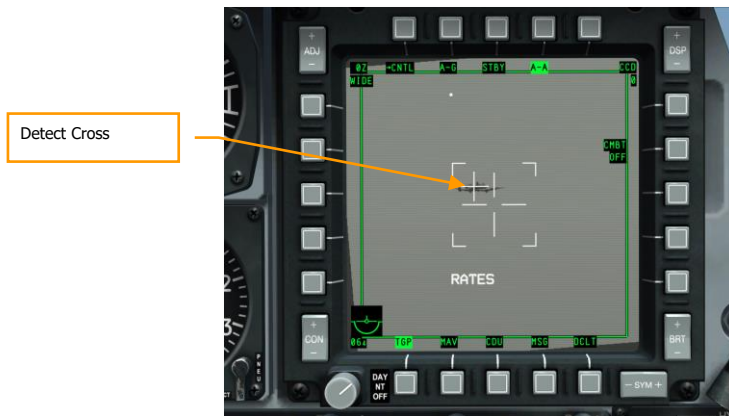

Figure 491. TGP A-A Target Detect

When the target is within the crosshair area, a smaller crosshair will be placed over the target to indicate that the TGP detects it. If the target flies outside the crosshair area, the tracking crosshair will disappear.

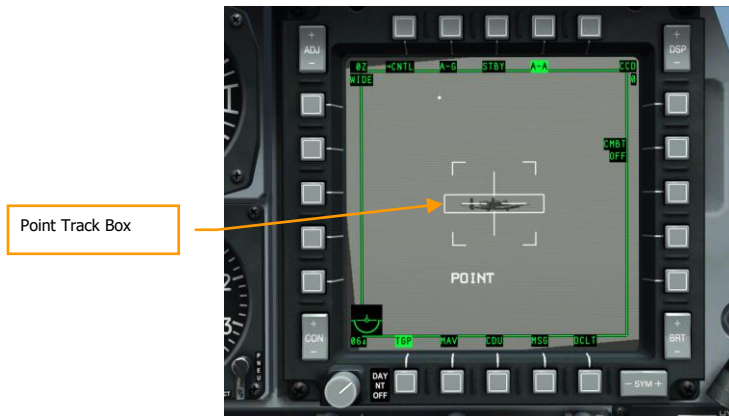

Figure 492. TGP A-A Target Point Track

- To initiate an auto-track of the target, press **TMS Forward Short**. Upon doing so, a tracking gate box will surround the target and the TGP will go into POINT tracking mode.

AIM/CATM-9M and 30 MM Cannon Use

Gun Use

The funnel is your gun aiming reference on the HUD and you will want to place the wing/rotor tips of the aircraft on the sides of the funnel to ensure proper angle and lead. Because the wing/rotor span can vary between aircraft, and this can lead to inaccuracy in the funnel sight, you will want to select the correct Air-to-Air Submenu (AAS) setting. With the HUD as SOI, press **DMS Left or Right Short** to cycle through the AAS aircraft options to match the aircraft you are engaging.

When you have selected the correct AAS setting and have the target within the funnel with just the wing/rotor tips touching the sides of the funnel, hold the gun trigger down. You can also use the AMIL to assist in gun aiming. This is a vertical line which represents the lead angle due to trajectory shift and gravity drop of rounds from close range out to approximately 2 seconds time of flight. The top of the AMIL shows where the bullets will be just after the firing burst and the distance they will fall towards the earth after 2 seconds due to deceleration and gravity drop.

AIM/CATM-9M Use

With an AIM/CATM-9M station selected on the DSMS, the seeker reticle will appear near the top of the HUD and represent where the seeker is currently looking. When keeping the seeker at this boresight position and maneuvering the aircraft to place the reticle over a target, you will likely hear the seeker detection or lock tone.

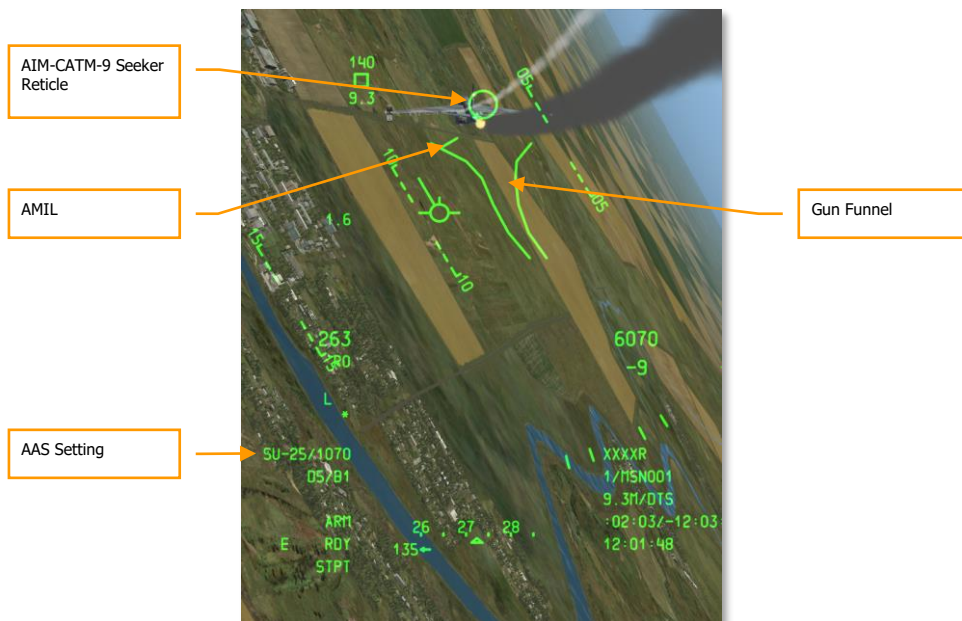

Figure 493. Air-to-Air HUD

To lock the seeker on to a target, you have several options:

- If you have set the target as SPI, you can use the Slave All to SPI command by pressing **China Hat Forward Long** and the seeker will automatically slave to the target.
- You can uncage the seeker by pressing **China Hat Forward Short** and the seeker will randomly drift. If it detects a good infrared target, it will lock on to it.

- Initiate a seeker conical scan by pressing **TMS Forward Short**. The seeker will then perform a circular scan around the boresight and automatically lock on to any good infrared target that enters the scan area.

To ensure a good lock, you can uncage the seeker to make sure it stays on the intended target by pressing **TMS Aft Short**.

With a valid lock, press and hold the **weapon release button** to fire the missile.

EMERGENCY PROCEDURES



EMERGENCY PROCEDURES

This chapter discusses the possible emergency conditions you may encounter and how to best address them. By applying what you learn in this chapter, you should be able to ensure maximum safety for you and the aircraft.

When encountering an emergency, you should always abide by the following three rules:

- Maintain aircraft control
- Analyze the situation
- Take the proper action as defined in this chapter

It is important to quickly recall the following procedures by memory and use sound judgment, common sense, and a full understanding of the applicable systems.

Often in this chapter we will use the terms “land as soon as possible” and “land as soon as practical”. By these terms we mean:

- **Land as soon as possible.** Land at the nearest suitable airfield immediately.
- **Land as soon as practical.** Mission should be terminated but immediate landing is not necessary.

Caution Light Panel Indications

This section discusses the possible caution light indications you may see and the corrective action to take.

AIL, L/R. Either the left or right aileron has jammed.

Corrective Action: Set the aileron emergency disengage switch towards the affected jam indicator light and monitor the AIL DISENG caution light.

AIL DISENG. Either the left or right aileron has been disengaged from the control stick.

Corrective Action: To re-engage either aileron, move the disengage switch back to center and then roll the aircraft back and forth if necessary.

AIL TAB, L/R. This will only happen when in manual reversion mode when the roll servo tab shift actuator has been extended.

Corrective Action: Exit out of manual reversion mode.

ANTI-SKID. This light will illuminate when either the anti-skid switch is set to OFF while the landing gear is down, or when the switch is set to ON but there is a failure in the circuit.

Corrective Action: If switch is set to OFF, set it to ON. If already on, brake carefully and avoid locking the brakes when landing.

APU GEN. The APU is not generating power yet the APU generator switch is set to PWR.

Corrective Action: Reduce the electrical load (shut down some electrical systems) and then cycle the APU generator switch.

BLEED AIR LEAK. A temperature sensor has detected bleed air leak.

Corrective Action:

1. Turn the bleed air switch to OFF
2. Set APU switch to OFF
3. Land as soon as practical

CADC. The Central Air Data Computer (CADC) has failed. Certain failures of the CADC can cause erroneous data to be displayed. The HUD will display the last valid airspeed and altitude data before the failure, and you will see a CADC FAIL and an INS DEGRADED message on the CDU.

Corrective Action: Select STBY or PNEU on the altimeter and monitor pitot-static airspeed indicator.

CICU. The Central Interface Control Unit (CICU) has failed.

Corrective Action: Check status of CDU on CDU Systems (SYS) page.

CONV, L/R. Either the left or right electrical converter has failed.

Corrective Action: Land as soon as possible.

EAC. The LASTE Enhanced Attitude Control (EAC) switch has failed.

Corrective Action: Cycle the EAC button and if that fails, press the MALF button on the UFC by pressing FUNC and then CLR.

ELEV, L/R. Left or right elevator has jammed.

Corrective Action: Set the elevator emergency disengage switch towards the affected jam indicator light and monitor the ELEV DISENG caution light.

ELEV DISENG. Either the left or right elevator has been disengaged from the control stick.

Corrective Action: To re-engage either elevator, move the disengage switch back to center and then pitch the aircraft up and down if necessary.

ENG HOT, L/R. Either Interstage Turbine Temperature (ITT) indication is exceeding 880-c.

Corrective Action: Retard throttles until ITT temperature returns to normal operating range.

ENG OIL PRESS, L/R. Oil pressure in either engine falls below 34 psi.

Corrective Action:

1. Set throttle of affected engine with oil problem to minimum (not IDLE)
2. If oil pressure can be maintained at 30 psi, set the affected engine throttle to IDLE
3. If oil pressure is still below 30 psi, set the affected engine throttle to OFF to avoid engine damage

ENG START CYCLE. An engine is conducting its automatic startup cycle and the air turbine starter solenoid valve is open with the throttle at IDLE but core engine speed below 56%. This light will also illuminate when either engine operate switch is in the MOTOR position.

Corrective Action: Allow engine start cycle to complete or move engine operate switch out of MOTOR position depending on engine start method.

FUEL PRESS, L/R. Indication of fuel pump failure due to either low differential fuel pressure or a clog in the engine feed line.

Corrective Action:

1. Set the Crossfeed switch to CROSSFEED.

2. If this does not extinguish the light(s), set the Crossfeed switch back to OFF and monitor fuel quantity to determine if a leak exists. If it appears a leak does exist, set the affected engine throttle to OFF and pull the fire T-handle of the affected engine.
3. If still the leak continues from the left system, set the left boost pump switches to OFF. If the right system continues to leak, set the right boost pump switches to OFF and set the SAS switches to OFF.

GCAS. The Ground Collision Avoidance System (GCAS) is inoperative.

Corrective Action: Set radar altimeter switch on LASTE panel to NRM and reset master caution light in UFC.

GEN, L/R. Either the generators are set to OFF/RESET or there is a failure. Such a failure will also lead to the failure of the Main and Wing fuel boost pumps and SAS channels.

Corrective Action:

1. If above 10,000 ft AGL, set the Crossfeed switch to CROSSFEED
2. Reset the failed generator switch back to OFF/RESET and then back to PWR
3. If after three attempts the generator does not come back online:
4. Set the failed generator back to OFF/RESET
5. Start APU when below 15,000 ft MSL
6. Set APU generator switch to PWR
7. Land as soon as practical

GUN UNSAFE. A live round remains in the barrel after the gun has been fired.

Corrective Action: Do not attempt to fire the gun and set the GUN/PAC and Master Arm switches on the AHCP to SAFE.

HARS. HARS is offline and not providing usable data.

Corrective Action: If HARS fails and is the active attitude reference source, you can restore yaw dampening and trim by:

- EGI is operating:
 1. Select EGI on the Navigation Mode Select Panel
 2. Reengage the YAW SAS channels
- EGI is not operating:

1. Set the CDU switch on the Auxiliary Avionics Panel to OFF
2. Set the EGI switch on the Auxiliary Avionics Panel to OFF
3. Set the HARS/SAS switch to the OVERRIDE position

HYD PRESS, L/R. This light will illuminate if either hydraulic system falls below 900 psi or manual reversion mode is enabled.

Corrective Action:

- If left system fails:
 1. Set the FLAP EMER RETR switch to EMER RETR on the Emergency Flight Control Panel
 2. If pressure continues to decrease:
 3. Set the SAS/Anti-skid paddle to OFF
 4. Keep Pitch SAS OFF
 5. Land as soon as possible
- If right system fails:
 1. Set the SP BK EMER RETR switch to EMER RETR on the Emergency Flight Control Panel
 2. If pressure continues to decrease:
 3. Set the SAS/Anti-skid paddle to OFF
 4. Keep Pitch SAS OFF
 5. Enable Anti-skid if left hydraulic system is still operable
 6. Land as soon as possible
- If both systems fail:
 1. Maintain 1G flight between 180 and 210 KIAS
 2. Set flaps to full UP (use emergency retract if needed)
 3. Jettison stores to produce symmetrical loading
 4. Enable Manual Reversion Mode

HYD RES, L/R. Volume of hydraulic fluid in the reservoir is low.

Corrective Action:

- If left system fails:
 1. Set the FLAP EMER RETR switch to EMER RETR on the Emergency Flight Control Panel
 2. If pressure continues to decrease:
 3. Set the SAS/Anti-skid paddle to OFF

4. Keep Pitch SAS OFF
 5. Land as soon as possible
- If right system fails:
 1. Set the SP BK EMER RETR switch to EMER RETR on the Emergency Flight Control Panel
 2. If pressure continues to decrease:
 3. Set the SAS/Anti-skid paddle to OFF
 4. Keep Pitch SAS OFF
 5. Enable Anti-skid if left hydraulic system is still operable
 6. Land as soon as possible
 - If both systems fail:
 1. Attain 1G flight between 180 and 210 KIAS
 2. Set flaps to full UP (use emergency retract if needed)
 3. Jettison stores to produce symmetrical loading
 4. Enable Manual Reversion Mode

IFF MODE-4. Mode-4 is inoperative due to IFF panel being zeroized or system failure.

Corrective Action: Set correct mode or exit interrogation environment.

INST INV. Instrument inverter switch is inoperative and indicates no power is being provided to the AC essential busses. This is indicative of the loss of both AC generators. Such a condition will also lead to the L and R ENG HOT caution lights illuminating.

Corrective Action:

1. Engine core speeds should be below 90% when below 25,000 MSL and 85% when above 25,000 MSL
2. Cycle Inverter switch between TEST and STBY and then leave in STBY
3. Start APU when below 15,000 MSL
4. Set the APU generator switch to PWR
5. Land as soon as practical

L-R TKS UNEQUAL. An imbalance of greater than 750 lbs. of fuel between the two main fuselage tanks has been detected.

Corrective Action:

1. Set the Crossfeed switch to CROSSFEED on the Fuel Control panel

2. Set wing boost pumps to OFF
3. If right system has less fuel: set right main boost pump switch to OFF
4. If left system has less fuel: set left main boost pump switch to OFF

LASTE. The Low Altitude Safety and Targeting Enhancement (LASTE) system is inoperative.

Corrective Action: Cycle the IFFCC switch on the AHCP.

MAIN FLOW LOW, L/R. Fuel quantity is below 500 lbs.

Corrective Action: Land as soon as possible.

MAIN PUMP, L/R. Indication of possible fuel boost pump failure due to fuel pressure differential at outlet of indicated main fuel boost pump is low.

Corrective Action: Failure of either main boost pump will illuminate the MAIN PUMP, L or R caution lights. Assuming wing boost pumps are still operating, the engines will still be provided fuel due to that pressure. If both main and wing boost pumps are not working though, suction-feed will supply the engines below 10,000 ft. Above this altitude, engine operation may suffer. In this event, set the Crossfeed switch to CROSSFEED. If this causes rapid fuel transfer between tanks, pull all Fill Disable switches.

NAV. There are multiple reasons this light may illuminate and most of them involve EGI state. Possible reasons for this caution and corrective actions include:

- EGI flight instrument failure
 1. Set the Navigation Mode Select Panel to HARS from EGI
 2. Verify an EGI FLY INST FAIL message on the CDU
 3. From the RESET page of the CDU, select the EGI line select key
- EGI is not ready failure
 1. Verify EGI switch is set to ON on the AAP
 2. Set the EGI switch to OFF for at least 10 seconds
 3. Reset the EGI switch back to ON
- EGI GPS failure
 1. On the CDU, verify a GPS FAIL message
 2. On the Navigation Mode Select Panel, ensure EGI is selected
 3. From the CDU RESET page, press the REINIT INS line select key, if failure persists...
 4. On the Navigation Mode Select Panel, select HARS

5. On the CDU REINIT page, press the REINIT GPS line select key
- EGI INS failure
 1. On the CDU, verify an INS FAIL message
 2. On the Navigation Mode Select Panel, ensure EGI is selected
 3. From the CDU RESET page, press the EGI line select key, if failure persists:
 - 3.1. On the Navigation Mode Select Panel, select HARS
 - 3.2. On the CDU REINIT page, press the REINIT GPS line select key
 - CDU failure
 1. On the AAP, set the CDU switch to OFF for at least 4 seconds
 2. Set the CDU switch back to the ON position. If the problem persists:
 - 2.1. Reload DTS data
 - 2.2. Select desired Navigation Mode Select Panel settings

OXY LOW. 0.5 liter or less of liquid oxygen remains in oxygen converters.

Corrective Action: Descend below 10,000 ft AGL and land as soon as practical.

PITCH SAS. One or both SAS channels have been disengaged.

Corrective Action: Reengage one channel at a time and if both cannot be reengaged, leave both off. Avoid single-channel operation as it can result in undesired loading on the interconnector shear bolts.

SEAT NOT ARMED. Seat ground safety lever in SAFE position.

Corrective Action: N/A

SERVICE AIR HOT. Indication of excessive pre-cooler output air temperature.

Corrective Action:

1. Turn the bleed air switch to OFF
2. Set APU switch to OFF
3. Land as soon as practical

STALL SYS. There has been a failure in the alpha/Mach computer and the stall warning will be inoperative. In such a situation, the slats extend automatically.

Corrective Action: Do not exceed 20 units of AoA.

WINDSHIELD HOT. Windshield anti-icing temperature is in excess of 150-F or aircraft is on battery electrical power only.

Corrective Action: N/A

WING PUMP, L/R. Indication of possible fuel boost pump failure due to fuel pressure differential at outlet of indicated wing fuel boost pump is low.

Corrective Action: If the L or R WING BOOST PUMP caution lights illuminate, it indicates the fuel in the tank of the boost pump will not transfer until the amount is below 600 lb. If left unchecked, this can lead to a weight imbalance. To remedy, select CROSSFEED from the Crossfeed switch on the Fuel panel. This will allow the tanks to equalize and maintain fuel balance. If, however, there is too rapid fuel transfer between tanks, you can pull the All Fill Disable switches.

YAW SAS. One or both YAW SAS channels have been disengaged.

Corrective Action: Reengage one channel at a time and if both cannot be reengaged, leave both off. Avoid single-channel operation as it can result in undesired loading on the interconnector shear bolts. On the Navigation Mode Select Panel, cycle between HARS and EGI to reset the attitude reference system and then attempt to reengage the channels.

Flight and Flight Control Emergencies

Flap Asymmetry

If the flaps fail to extend or retract symmetrically, you should attempt the following remedies in order:

1. Re-select the flap position at which the asymmetry first occurred. If that does not work:
 - 1.1. Set flaps to MVR setting when speed and altitude allow. If that does not work:
 - 1.1.1. On the Emergency Flight Control Panel, enable the FLAP EMER RETR switch by moving the switch up.

Speed Brake Asymmetry or Failure

On the Emergency Flight Control Panel, move the SPD BK EMER RETR switch up to close.

Aileron/Elevator Jam

Indicated by either a AIL, L/R or ELEV, L/R caution panel light, one or more aileron or elevator control surfaces have jammed. Disengage the control and allow normal movement of the controls, move the emergency disengage switch on the Emergency Flight Control Panel in the direction of the jam indicator light.

Hydraulic Failure

The aircraft has both left and right hydraulic systems and the failure of one still allows adequate flight control response. Failure of either the systems can be indicated by the L and R HYD RES (hydraulic fluid reservoir low) caution light or the L and R HYD PRESS (hydraulic pressure low) caution light. However, the loss of one hydraulic system will reduce rudder authority.

If the left hydraulic system fails, you will lose the following systems:

- Flaps
- Nosewheel steering
- Normal landing gear operation
- Wheel brakes
- Anti-skid
- Hydraulic control of the left elevator and rudder actuators
- Loss of dual channel pitch and yaw SAS

If left system fails:

1. Set the FLAP EMER RETR switch to EMER RETR on the Emergency Flight Control Panel.
2. If pressure continues to decrease:
 - 2.1. Set the SAS/Anti-skid paddle to OFF
 - 2.2. Keep Pitch SAS OFF
 - 2.3. Land as soon as possible

If the right hydraulic system fails, you will lose the following systems:

- Slats (will extend with loss of hydraulic power)
- Air refueling slipway and nozzle hatch rollers
- Speed brakes
- Right elevator and rudder actuators
- Loss of dual channel pitch and yaw SAS

If right system fails:

1. Set the SP BK EMER RETR switch to EMER RETR on the Emergency Flight Control Panel.
2. If pressure continues to decrease:
 - 2.1. Set the SAS/Anti-skid paddle to OFF
 - 2.2. Keep Pitch SAS OFF
 - 2.3. Enable Anti-skid if left hydraulic system is still operable
 - 2.4. Land as soon as possible

If both systems fail:

1. Maintain 1G flight between 180 and 210 KIAS
2. Set flaps to full UP (use emergency retract if needed)
3. Jettison stores to produce symmetrical loading
4. Enable Manual Reversion Mode

Trim Failure

If the normal aircraft trim system fails, set the PITCH/ROLL TRIM switch to EMER OVERRIDE on the Emergency Flight Control Panel and then use the emergency pitch and roll trim switch to set desired trim.

Out-of-Control Recovery

If the aircraft departs from controlled flight as the result of an un-commanded roll reversal or spin, it can be easily recovered from after a few control oscillations. To recover:

1. Neutralize all controls until oscillations have ceased. Trying to rush the recovery may only exacerbate the problem.
2. Set throttles to IDLE.
3. If in a spin, full input of rudder opposite of turn needle.

Note that a spin can take between 4,000 and 10,000 feet to recover from depending on severity.

Hypoxia

If you are not receiving enough oxygen above 20,000 ft MSL, you may suffer the effects of hypoxia and lose consciousness. If you start to see visual effects, you must ensure:

- Oxygen lever is set to ON.
- Oxygen flow indicator is blinking.
- Oxygen pressure is above 55 psi.

If set correctly and effects are still present, descend below 13,000 ft.

Manual Reversion Landing

When landing in Manual Reversion Flight Control System (MRFCS) mode, the landing should only be attempted in ideal conditions and flight controls should not be degraded, maximum allowed crosswind is 20 knots, no ECM pods can be loaded on stations 1 and 11, and you must never use pitch trim for flaring the aircraft. If you cannot meet these conditions, you should eject from the aircraft. To perform an MRFCS landing:

1. Jettison external fuel tanks.
2. Extend landing gear either normally or with AUX LG EXT handle.
3. Pull the EMER BRAKE handle.
4. Fly a straight in approach at 1.5 to 2 degrees with low sink rate.
5. When below 50 ft AGL, pitch response becomes degraded.
6. Maintain minimum airspeed around 140 KIAS to touchdown.

Engine, APU, and Fuel Emergencies

Engine Fire

If an engine fire is detected in either engine, the engine fire right or left T-Handle will illuminate. In case of such a fire, follow these steps:

1. Reduce power to affected engine and monitor if the fire light goes out. If the fire persists:
 - 1.1. Set the throttle of the affected engine to OFF.
 - 1.2. Pull the fire T-Handle of the affected engine.
 - 1.3. Press the fire discharge agent switch left or right.
 - 1.4. If both presses of the discharge agent switch fail to put out the fire, land as soon as possible.

APU Fire

If an APU fire is detected, the APU fire T-Handle will illuminate. This will likely be accompanied with a Bleed Air Leak caution light. In case of such a fire, follow these steps:

1. If the APU is operating, set the APU switch to OFF. If the fire persists:

- 1.1. Pull the fire T-Handle of the APU.
- 1.2. Press the fire discharge agent switch left or right.
- 1.3. If both presses of the discharge agent switch fail to put out the fire, land as soon as possible.

Single Engine Restart

If an engine needs to be restarted while in flight you can either use the APU to restart the engine or perform a windmill air start.

APU Restart. Using the APU to restart an engine is performed as follows:

1. Move the inoperative engine throttle to the OFF position.
2. Observe that the shut-down engine ITT value cools down rapidly.
3. Aircraft altitude should be below 20,000 ft MSL and increase airspeed.
4. When below 15,000 ft MSL, move the APU power switch to the START position.
5. Move the still operating throttle to MAX.
6. Set the Engine Operate switch of the affected engine to the MOTOR setting.
7. When affected engine ITT is below 100°C and altitude below 15,000 ft MSL, restart the affected engine by moving the throttle from OFF to IDLE.
8. Move the Engine Operate switch of the affected engine back to the NORM position.
9. If engine restart is successful, reengage the SAS switches.

Windmill Restart. Using a windmill start will take 6,000 to 8,000 ft to complete because it requires a steep dive of at least 30°. Given the altitude requirement, this is not an option when below 10,000 ft AGL. To perform a windmill restart:

1. Place the aircraft in a 30° dive.
2. Set the Bleed Air switch to OFF.
3. Set the Crossfeed switch to Crossfeed.
4. Once ITT of affected engine is below 150-c, set both throttles to MAX.
5. Set the Engine Operate switch of the affected engine to IGN.
6. Once engine is operating, move Engine Operate switch back to NORM.
7. Move Crossfeed switch to OFF.
8. Set Bleed Air switch to ON.

Engine Start after a Failed Start

If an engine fails to start using the automatic NORM mode, the engine combustion chamber may be flooded with fuel and needs to be purged before it can be restarted or risk a hot start. A failed start

can happen if you fail to set the Inverter switch to STBY, causing the inverters to fail to provide power to the engine igniters. To purge an engine of fuel:

1. Set the Throttle of the affected engine to OFF.
2. Set the Engine Operate switch of the affected engine to the MOTOR position for 30 seconds.

After completing the purge, you can attempt to restart the engine after correcting what prevented the engine from starting earlier.

APU Over-temperature

If the APU temperature begins to fluctuate or experiences an over-temperature, you need to shut it down immediately by setting the APU power switch to OFF. If airborne, land as soon as practical. If however the APU is needed for engine start or electrical power, you can try to restart the APU and closely monitor it. Avoid running the APU when one or both engines are running above 80% core RPM as a bleed air failure can cause aircraft damage.

Engine Oil Malfunction

If the oil pressure for either engine is outside its normal operating limits, you need to take the following steps:

1. Set throttle of affected engine with oil problem to minimum (not IDLE).
2. If oil pressure can be maintained at 30 psi, set the affected engine throttle to IDLE.
3. If oil pressure is still below 30 psi, set the affected engine throttle to OFF to avoid engine damage.

Main Fuel Boost Pump Failure

Failure of either main boost pump will illuminate the MAIN PUMP, L or R caution lights. Assuming wing boost pumps are still operating, the engines will still be provided fuel due to that pressure. If both main and wing boost pumps are not working though, suction-feed will supply the engines below 10,000 ft. Above this altitude, engine operation may suffer. In this event, set the Crossfeed switch to CROSSFEED. If this causes rapid fuel transfer between tanks, pull the Fill Disable switches.

Wing Fuel Boost Pump Failure

If the L or R WING BOOST PUMP caution lights illuminate, it indicates the fuel in the tank of the boost pump will not transfer until the amount is below 600 lb. If left unchecked, this can lead to a weight imbalance. To remedy, select CROSSFEED from the Crossfeed switch on the Fuel panel. This

will allow the tanks to equalize and maintain fuel balance. If however there is too rapid of a fuel transfer between tanks, you can pull the Fill Disable switches.

Fuel Pressure Low or Fuel Leak

This is indicated by either the L-FUEL PRESS or R-FUEL PRESS caution lights illuminating. If either light illuminates, set the Crossfeed switch to the CROSSFEED position.

If this does not extinguish the light(s), set the Crossfeed switch back to OFF and monitor fuel quantity to determine if a leak exists. If it appears a leak does exist, set the affected engine throttle to OFF and pull the fire T-handle of the affected engine.

If the leak still continues from the left system, set the left boost pump switches to OFF. If the right system continues to leak, set the right boost pump switches to OFF and set the SAS switches to OFF.

Emergency Landings and Exiting

Single Engine Landing

When one of the engines has failed and a safe, controlled flight is still possible, a landing can still be performed using the following guidance:

1. Ensure the failed engine will cause no damage to the aircraft due to fire.
2. Use the rudders to compensate for yaw due to single engine operation. If possible, bank into the direction of the operating engine.
3. Advance the operating engine throttle to MAX.
4. Close speedbrakes if open.
5. Set flaps to MVR setting.
6. A straight in approach should be used and all set up maneuvering completed 2 to 3 nm from touchdown point.
7. If level flight with maximum power cannot be maintained, external stores should be jettisoned.
8. Lower the landing gear and compensate for increased drag.
9. Reduce power slowly during landing flare with careful and coordinated rudder input to keep aircraft aligned down the runway.

Flameout Landing

If an ejection is not possible, a flameout landing should be attempted. A flameout landing is when both engines are not producing any thrust and you must land.

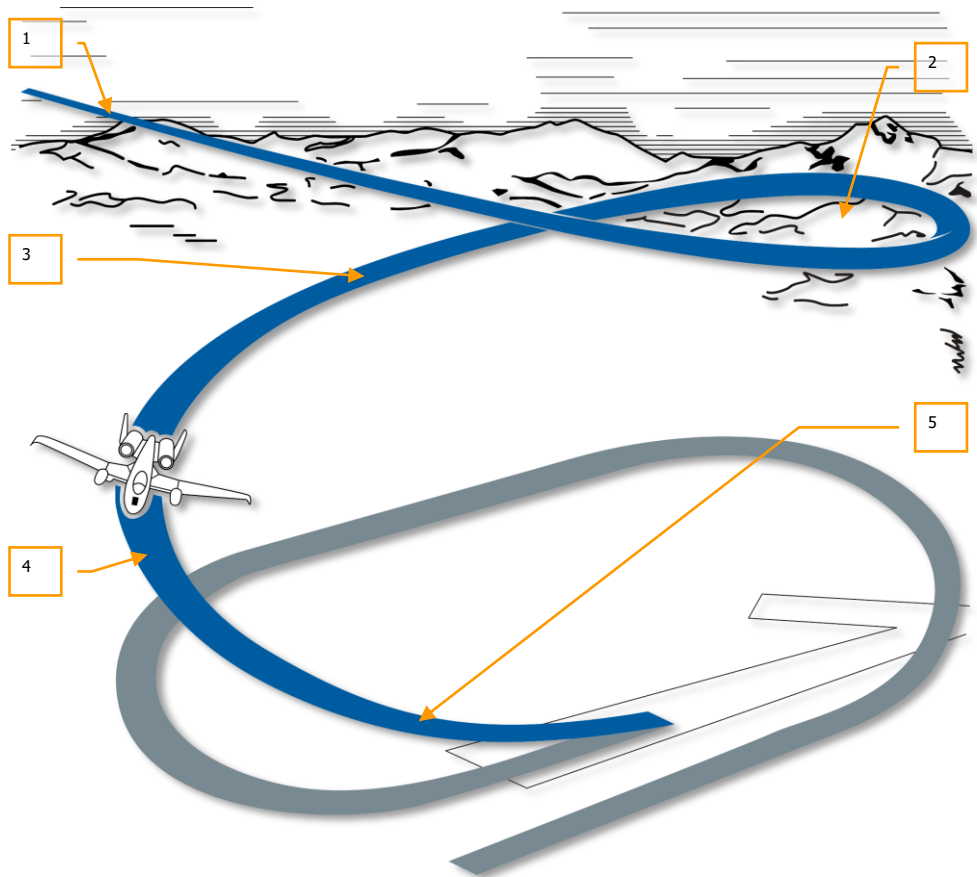

Figure 494. Flameout Approach

Enter landing pattern with a very steep approach using a circular pattern which will result in a low displacement 8,000 ft from the runway. All turns within the pattern should be limited to 30° of bank.

Lower landing gear with a minimum airspeed of 160 KIAS. Altitude should be between 7,000 and 6,500 ft AGL.

Maintain 160 KIAS and altitude should be between 3,500 and 4,000 ft AGL.

On the base leg, maintain 160 KIAS and an altitude of between 2,000 and 2,500 ft AGL.

Roll out on final should be initiated early due to the slow roll response of the aircraft if in manual reversion mode. Final approach will have aircraft at 150 KIAS wings level above 500 ft AGL. Touchdown should occur 1/3 down the runway. The landing flare should be done at 120 KIAS when 200 to 300 ft AGL over the runway. When 50 ft AGL, shallow the flight path to 1.5 to 2 degrees. Note that pitch response will be greatly degraded when below 50 ft AGL due to the ground effect.

Once on the ground, emergency brakes should be used because no anti-skid, flaps, or speed brakes will be available.

Landing Gear Extension Failure

Ideally, you always want to land with all three landing gears extended and locked with three green gear-down indicators on the landing gear panel. If moving the landing gear handle to the down position does not result in three down and locked lights, you should try the following:

1. Press the Signal Lights button to make sure the lights are operating.
2. Check that there is pressure in the left hydraulic system. If pressure looks good...
3. Cycle the landing gear handle back up and then down again.
4. Increase airspeed to 200 KIAS and pitch and roll the aircraft to shake loose the gear.
5. If all this fails, use the Landing Gear Alternative Extension Handle. To use this handle:
6. Reduce airspeed below 200 KIAS
7. Ensure landing gear handle is down
8. Pull AUX LG EXT handle along the lower left side of the center dash

No Gear Down or Partial Gear Down Landings

If you are unable to lower the landing gear as described above, you will need to perform a wheels-up landing. To perform a wheels-up landing, follow these steps:

1. Push in the AUX LG EXT handle.
2. Jettison all stores and flares.
3. Burn off excess fuel.
4. Pull the EMER BRAKE.

5. Set speed brakes to 40%.
6. Lower flaps to 20°.
7. Fly shallow approach at 2° at normal airspeed.
8. Touchdown at a minimum sink rate on center of runway.
9. After touchdown, open speed brakes to full.
10. Reduce throttles to IDLE.
11. Move control stick to full aft.
12. Once you have come to a stop, set the throttles to OFF.

Ejection

Using the ejection seat, you can exit the aircraft at most any speed and altitude, but ejection above 2,000 ft AGL wings level is preferable. If below 2,000 ft AGL, do not delay in making the decision. If in uncontrolled flight, eject at an altitude above 4,000 ft AGL. If time permits, the following steps should be taken before ejecting from the aircraft:

1. Set IFF panel to EMER and set appropriate Mode 3/A code.
2. Transmit "May Day" call on UHF guard channel.
3. Turn aircraft to uninhabited area.
4. Trim aircraft for lowest practical speed with wings level.
5. When ready to eject, pull either ejection handle, and the process will start immediately.

CHECKLISTS



CHECKLISTS

Aircraft Startup Preparation

Panel	Controls	Operation	Key commands
Left console	Intercom panel volume levels	Rotate knobs as needed	
Left console	VHF radio 1 channel preset select (check radio assignments)	Check preset channel in PRESET window according to briefing	
Left console	VHF radio 2 channel preset select (check radio assignments)	Check preset channel in PRESET window according to briefing	
Left console	UHF radio channel preset select (check radio assignments)	Check preset channel in PRESET window according to briefing	
Left console	Radar altimeter on LASTE panel to Normal	Set to NRM position	
Left console, EFC panel	Emergency flap retract (FLAP EMER RETR)	Set to aft	
Left console, EFC panel	Flight control mode (FLT CONT)	Set to NORM	
Left console, EFC panel	Aileron emergency disengage (AILERON EMER DISENGAGE)	Center switch	
Left console, EFC panel	Elevator emergency disengage (ELEVATOR EMER DISENGAGE)	Center switch	

Panel	Controls	Operation	Key commands
Left console, EFC panel	Speed brake emergency retract (SPD BK EMER RETR)	Set to aft	
Left console, EFC panel	Emergency pitch/roll trim (PITCH/ROLL TRIM)	Set to NORM	
Left console, throttle quadrant area	HARS/SAS switch	Set to NORM	
Left console, throttle quadrant area	Refuel Status and Indexer Lights dial (REFUEL STATUS & INDEXER LTS)	Rotate to desired brightness	
Left console, throttle quadrant area	Night vision lights (NVIS LTS) switch	Set to OFF	
Left console, throttle quadrant area	Master exterior light switch	Set to aft	
Left console, throttle quadrant area	Throttles	Confirm full aft to OFF	
Left console, throttle quadrant area	Flap lever, confirm on Landing Gear and Flap Control panel	Confirm to UP	
Left console, throttle quadrant area	Speed brakes	Confirm to be fully closed	
Left console, throttle quadrant area	APU power (APU) switch	Set to OFF	
Left console, throttle quadrant area	Engine operate (ENG OPER) switches	Both set to NORM	

Panel	Controls	Operation	Key commands
Left console, throttle quadrant area	Engine fuel flow (ENG FUEL FLOW) switches	Both set to NORM	
Left console, fuel system panel	Main fuel boost pump (BOOST PUMPS MAIN) switches	Both set to MAIN	
Left console, fuel system panel	Wing fuel boost pump (BOOST PUMPS WINGS) switches	Both set to WING	
Left console, fuel system panel	Main fill disable (FILL DISABLE MAIN) switches	All depressed	
Left console, fuel system panel	Wing fill disable (FILL DISABLE WINGS) switches	All depressed	
Left console, fuel system panel	Air refuel lever	Forward to CLOSE	
Left console, fuel system panel	Tank gate (TK GATE) switch	Set to CLOSE	
Left console, fuel system panel	Crossfeed (CROSS FEED) switch	Set to OFF	
Front dash, landing gear panel	Landing gear handle	Set to down position	
Front dash, landing gear panel	Landing/Taxi lights (LIGHTS)	Set to OFF	
Front dash, AHCP	Master Arm (MASTER) switch	Set to SAFE	

Panel	Controls	Operation	Key commands
Front dash, AHCP	GUN/PAC switch	Set to SAFE	
Front dash, AHCP	LASER switch	Set to SAFE	
Front dash, AHCP	Targeting Pod (TGP) switch	Set to OFF	
Front dash, AHCP	Central Interface Control Unit (CICU) switch	Set to OFF	
Front dash, AHCP	Joint Tactical Radio System (JTRS) switch	Set to OFF	
Front dash, AHCP	Integrated Flight and Fire Control computer (IFFCC) switch	Set to OFF	
Front dash	Multi-Function Color Displays (MFCD) power switches	Both set to OFF	
Front dash	Accelerometer (G-Meter)	Reset	
Front dash	Fire T-Handles (Left Engine, APU, Right Engine)	All three are in	
Front dash	Fire agent discharge switch	Switch is centered	
Front dash	Standby compass	Check reading accuracy	
Front dash	Auxiliary landing gear extension handle (AUX LG EXT)	Handle is in	
Right console, electrical power control panel	Auxiliary Power Unit generator switch (APU GEN) switch	Set to OFF/RESET	
Right console, electrical power control panel	AC Inverter (INVERTER) switch	Set to OFF	

Panel	Controls	Operation	Key commands
Right console, electrical power control panel	BATTERY switch	Set to OFF	
Right console, Countermeasure Signal Processor panel	MODE dial	Set to OFF	
Right console, Countermeasure Signal Processor panel	SYSTEM switches	All set to OFF	
Right console, ILS panel	Power switch	Set to OFF	
Right console, AAP	Control Display Unit (CDU) switch	Set to OFF	
Right console, AAP	Embedded GPS INS (EGI) switch	Set to OFF	
Right console, AAP	PAGE knob	Set to OTHER	
Right console, AAP	STEER PT knob	Set to MISSION	
Right console, TACAN panel	Mode dial	Set to OFF	
Right console, lighting panel	Lighting controls	Set as desired	
Ejection seat	Ejection seat arm handle	Set to Armed	

Aircraft Startup

Electrical Startup

Panel	Controls	Operation	Key commands
Right console, electrical power control panel	BATTERY switch	Set switch to ON	
Right console, electrical power control panel	AC Inverter (INVERTER) switch	Set to STBY	
Right console, electrical power control panel	Left and Right AC Generator switches	Set both to Power	
Right console, electrical power control panel	Emer Flood switch	Set to on at night	
Front dash	Engine group instruments, ITT indicators	ITT below 150c	
Left console, auxiliary lighting panel	SIGNAL LIGHTS LAMP TEST	Press button and check light illuminations	
Front dash, fuel quantity panel	Fuel quantity pointers	Totalizer should be 6,000 with main tanks full	
Front dash	Digital clock	Set clock as needed	
Environmental control panel	Oxygen supply lever	Set to on	

Panel	Controls	Operation	Key commands
VHF/AM radio	Mode switch	Set to TR	
UHF radio	Function switch	Set to Main	
VHF/FM radio	Mode switch	Set to TR	
VHF and UHF radios	Frequency selection	Set frequencies as needed	
Intercom panel	Volume switches	Pull HM, IM, FM, VHF, UHF - adjust volume as needed	

APU Startup

Panel	Controls	Operation	Key commands
Left console, throttle quadrant area	APU power (APU) switch	Set to START	
Front dash	Engine group instruments, APU indicators	Monitor that APU EGT stabilizes between 400 and 450c and APU RPM at 100%	
Right console, electrical power control panel	Auxiliary Power Unit generator switch (APU GEN) switch	Set to PWR when APU stabilizes at 100%	
Lighting panel	Formation lights switch	Set to AFT	
Lighting panel	Position lights switch	Set to FLASH	
Throttle	Master external lights switch	Set to AFT	
Lighting panel	Cockpit lighting controls	Set as desired	
Radio Comms	ATC	Request engine start	

Engines Startup

Panel	Controls	Operation	Key commands
Left engine startup			
Left console, throttle quadrant area	Engine operate (ENG OPER) switches	Confirm both set to NORM	
Left console, throttle quadrant area	Left throttle	Move from OFF to IDLE position	
Front dash	Engine group instruments	Monitor that the left engine core speed normalized at 56%	
Right console, electrical power control panel	AC generator (AC GEN) switches	Confirm switches set to PWR	
Front dash, fuel quantity panel	Left hydraulic system pressure gauge	Monitor that pressure is between 2,800 and 3,350 psi	
Right engine startup			
Left console, throttle quadrant area	Right throttle	Move from OFF to IDLE position	
Front dash	Engine group instruments	Monitor that the right engine core speed normalized at 56%	
Front dash, fuel quantity panel	Right hydraulic system pressure gauge	Monitor that pressure is between 2,800 and 3,350 psi	

Panel	Controls	Operation	Key commands
Speed brakes	Speed brakes	Cycle speed brakes open and closed and monitor hydraulic psi	
Right console, electrical power control panel	APU Generator switch	Set to OFF	
Left console, throttle quadrant area	APU power (APU) switch	Set to OFF	

Pre-Flight Checks and Set Up

Panel	Controls, checks	Check, operation, message	Key commands
Right console, AAP	Control Display Unit (CDU) switch	Set to ON	
Right console, AAP	Embedded GPS INS (EGI) switch	Set to ON	
Right console, CDU	BIT and alignment	Allow BIT and alignment to complete	
Right console, CDU	Alignment Page	Select NAV when alignment complete	
Right console, CDU	Load Flight Plan	Load Flight Plan from FPM FSK	
Front dash, AHCP	Targeting Pod (TGP) switch	Set to ON	
Front dash, AHCP	Central Interface Control Unit (CICU) switch	Set to ON	
Front dash, AHCP	Joint Tactical Radio System (JTRS) switch	Set to ON	
Front dash, AHCP	Integrated Flight and Fire Control computer (IFFCC) switch	Set to TEST	
Front dash	MFCD	Turn on both MFCD with power knob	
Front dash	MFCD, Configure datalink, TAD	Set GROUP and OWN ID from TAD Network page	

Panel	Controls, checks	Check, operation, message	Key commands
Front dash	MFC/D, STAT page	Check for malfunctions and adjust slew speed as desired	
Left console, SAS panel	Takeoff trim (T/O) button	Press	
Left console, SAS panel	SAS channel switches	Test SAS channel engage and disengage	
Front Dash	Navigation Mode Select Panel (NMSP)	Press EGI button	
Left console, EFC panel	Emergency pitch/roll trim (PITCH/ROLL TRIM)	Switch to EMER and test manual setting and then switch back to NORM	

Final Checks and Taxi

Panel	Controls	Operation	Key commands
Right console	Canopy switch	Move switch to down position	
Left console, throttle quadrant	Throttles	Move from IDLE to MAX and back to IDLE within 2 seconds. Core RPM should not exceed 70%	
Control stick	Nosewheel steering button	Engage	

Panel	Controls	Operation	Key commands
Left console, throttle quadrant	Flap lever, monitor on Landing Gear and Flap Control Panel	Set to DN at 20 degrees	
Right console, environment panel	Oxygen flow switch	Set to NORMAL	
Right console, lighting panel	Light switches and dials	Strobe set to OFF, NAV lights set to DIM FLASH	
Taxi			
Left console, throttle quadrant	Throttles	Taxi speed between 15 and 25 knots	
Rudders	Rudder pedals	Use pedals to ground steer aircraft	
Stop			
Left console, throttle quadrant	Throttles	Set to IDLE	
Rudders	Rudder pedals	Push on toe brakes	

Engine Run Up Checks

Panel	Controls	Operation	Key commands
Right console, lighting panel	Light switches and dials	DAY: Strobe set to ON; NAV lights set to STEADY NIGHT: Strobe set to ON, NAV lights set to STEADY, Taxi lights ON	
Right console, environment panel	Pitot Heat switch	Set to ON	
Rudders	Rudder pedals	Hold down toe brakes	
Left panel, throttle quadrant	Throttles	Advance to 90% core RPM	
Front dash, engine instrument group	Engine indicator gauges	Monitor for normal engine operation	

Takeoff

Panel	Controls	Operation	Key commands
Rudders	Rudder pedals	Release toe brakes	
Front dash, engine instrument group	Engine indicator gauges	Monitor for normal engine operation	

Panel	Controls	Operation	Key commands
Control stick	Nosewheel steering button	Disengage over 70 knots	
Control stick	Control stick pitch	Pull back to 10 degrees at 10 knots prior to takeoff speed	

Embedded GPS INS (EGI) Navigation

Panel	Controls	Operation	Key commands
Waypoint Selection			
Right console, AAP panel	PAGE dial	Set to WAYPT	
Right console, CDU	Waypoint Page	Enter name of waypoint in scratchpad and press top right line select key.	
Right console, CDU	Waypoint Page	Enter ID number of waypoint in scratchpad and press top left line select key.	
Creating New Waypoint			
Right console, AAP panel	PAGE dial	Set to WAYPT	
Right console, CDU	PAGE display	Select waypoint branch	
Right console, CDU	Waypoint Info page	Select Copy (?xx) function to create new mission waypoint	

Panel	Controls	Operation	Key commands
Right console, CDU	Waypoint Info page	Enter elevation of new waypoint in scratchpad and press EL line select key	
Right console, CDU	Waypoint Info page	Enter latitude of new waypoint in scratchpad and press N/S line select key	
Right console, CDU	Waypoint Info page	Enter longitude of new waypoint in scratchpad and press E/W line select key	
Right console, CDU	Waypoint Info page	Enter unique name of new waypoint in scratchpad and press name field line select key	
Set Steerpoint			
Right console, AAP panel	PAGE dial	Set to STEER	
Right console, CDU	Steerpoint Info page	Cycle with ± rocker on CDU	
HUD	HUD as SOI	DMS Up and Down	
Set Anchor Point			
Right console, AAP panel	PAGE dial	Set to WAYPT	
Right console, CDU	PAGE display	Select Anchor Pt branch	

Panel	Controls	Operation	Key commands
Right console, CDU	Anchor Point Info page	Enter name of waypoint in scratchpad and press top right line select key.	
Right console, CDU	Anchor Point Info page	Enter ID number of waypoint in scratchpad and press top left line select key.	
Mark Creation and Cycling			
Right console, CDU	MK (Markpoint) button	Press to create overhead markpoint	
TDC, TAD Cursor, TGP, and Maverick	Designation point	TMS Right Short to set markpoint	
Right console, AAP panel	STEER PT dial	Set to MARK	
Right console, CDU	± Rocker switch	Press to cycle markpoints	
HUD	HUD as SOI	DMS Up and Down to cycle markpoints	
Create Flight Plan			
Right console, AAP panel	PAGE dial	Set to OTHER	
Right console, AAP panel	STEER PT dial	Set to FLT PLAN	
Right console, CDU	FPM Function Select Key	Press	
Right console, CDU	FPM Info Page	Enter name of new FP in scratchpad and press NEW FP line select key	

Panel	Controls	Operation	Key commands
Right console, CDU	FPM Info Page	Press line select key of new flight plan	
Right console, CDU	FPM Info Page	Press FPBUILD line select key	
Right console, CDU	Flight Plan Build page	Enter waypoint number of waypoint to be added to plan in scratchpad and press line select key of flight plan slot	
Right console, CDU	Flight Plan Build page	Repeat to add all waypoints of new flight plan	
Set Desired Time on Target (DTOT)			
Right console, AAP panel	PAGE dial	Set to WAYPT	
Right console, CDU	Waypoint Page	Enter name of waypoint in scratchpad and press top right line select key.	
Right console, CDU	Waypoint Page	Enter ID number of waypoint in scratchpad and press top left line select key.	
Right console, CDU	Waypoint Page	Enter hour/minute/second (xx-xx-xx) of DTOT in scratchpad and press DTOT line select key	

Radio ADF Navigation

Panel	Controls	Operation	Key commands
VHF Radios			
Front dash, navigation mode select panel	ILS and TCN buttons	Disengage	
Left console, VHF radio head	Mode Selector knob	Set to DF	
Left console, VHF radio head	Frequency switches	Set ADF frequency	
Font dash, navigation mode select panel	VHF Light	Confirm lit	
Front dash	ADI	Steer towards Bank Steering bar and monitor Pitch Steering Bar regarding ADF signal strength	
UHF Radio			
Left console, UHF radio head	Function Select switch	Set to ADF	
Left console, UHF radio head	Frequency switches	Set ADF frequency	

Panel	Controls	Operation	Key commands
Font dash, navigation mode select panel	UHF Light	Confirm lit	
Front dash	HSI	Follow Bearing Pointer 1 steering	

Countermeasure Panel Programming

Panel	Controls	Operation	Key commands
Right console, CMSP panel	Mode Select dial	Set to STBY	
Right console, CMSP panel	DISP switch	Set to MENU	
Right console, CMSP panel	CHAFF, FLAR, INTV, or CYCL SET button	Press to enter value	
Right console, CMSP panel	Next (NXT) rocker switch	Press to adjust value	
Right console, CMSP panel	Return (RTN) button	Save data	
Right console, CMSP panel	DISP switch	Set to ON	
Right console, CMSP panel	RWR switch	Set to ON	

Panel	Controls	Operation	Key commands
Right console, CMSP panel	JMR switch	Set to ON	
Right console, CMSP panel	MWS switch	Set to ON	

Targeting Pod

Panel	Controls	Operation	Key commands
Basic TGP Operation			
Front dash, AHCP	TGP switch	Set to ON	
Front dash, MFC	TGP OSB	Press	
Front dash, MFC	TGP STBY page	Press A-G OSB 2 or A-A OSB 3 for Ground or Air modes	
Left console, throttle	Slew Switch	Slew TGP line of sight	Move Slew Switch
Left console, throttle	China Hat Forward Short	Change field of view	Press China Hat Forward Short
Left console, throttle	Boat Switch	Set BHOT or WHOT infrared camera or CCD	Set Boat Switch
Control stick	DMS Forward and Aft	Adjust zoom level	Press DMS Forward or Aft
Control stick	TMS Forward Short	Select tracking mode	Press TMS Forward Short
Control stick	TMS Forward Long	Set SPI	Press TMS Forward Long
Laser Spot Search (LSS) Mode			
Front dash, AHCP	TGP switch	Set to ON	
Front dash, MFC	TGP OSB	Press	
Front dash, MFC	TGP STBY page	Press A-G OSB 2 for Ground mode	

Panel	Controls	Operation	Key commands
Front dash, MFC D	TGP A-G page	Press CNTL OSB 1 for Control page	
Front dash, MFC D	TGP A-G CNTL page	Set LSS code	
Left console, throttle	TGP A-G CNTL page	Press RTN OSB 1 to return to A-G page	
Left console, throttle	Slew Switch	Slew TGP LOS to designation area	Move Slew Switch
Control stick	DMS Right Long	Slave TGP to HMCS LOS	Press DMS Right Long
Control stick	TMS Forward Short	Start track on LST location	Press TMS Forward Short

Weapon Selection and Arming

Panel	Controls	Operation	Key commands
Front dash, AHCP	Master Arm switch	Set to ON	
Front dash, AHCP	GUN/PAC switch	Set to ON	
Front dash, AHCP	LASER switch	Set to ON	
Front dash, MFC D	DSMS Status page	Review store loading and resolve errors	
Weapon Profile Select			

Panel	Controls	Operation	Key commands
Front dash, MFC	DSMS Profile page	Select desired profile using OSB 19 and 20	
Front dash, MFC	DSMS Profile page	Set selected profile as active by pressing ACT PRO OSB 17	
Front dash, MFC	DSMS Profile Control page	Set release control as desired. Enter value in scratchpad and press OSB next to setting	
Front dash, MFC	DSMS Settings page	Set release settings as desired. Enter value in scratchpad and press OSB next to setting	
Manual Profile Select			
Front dash, MFC	DSMS Status page	Press OSB next to weapon station	
HUD Rotary Profile Select			
HUD	HUD as SOI	Press DMS Left and Right to cycle through profiles on HUD rotary	Press DMS Left or Right Short

Hung IAM Station

Panel	Controls	Operation	Key commands
Front dash, MFC	DSMS INV pages	Reload hung (red) station	
Front dash, MFC	STAT page 1	Power failed station off and then on	
Front dash, MFC	DTS page	Reload ALL	

Weapon Delivery

Panel	Controls	Operation	Key commands
Gun			
Left console, AHCP	Master Arm switch	Set to ARM	
Left console, AHCP	GUN/PAC switch	Set to ARM	
Control stick	Master Mode Select Button	Set mode to GUNS	Press Master Mode Select Button
Left console, throttle	Coolie Hat up	Set HUD as SOI	Press Coolie Hat Up
Control stick	DMS Left or Right Short	Select gunsight	Press DMS Left or Right Short
Control stick	Trigger	First stage enables PAC, second stage fires gun	
Rockets			

Panel	Controls	Operation	Key commands
Left console, AHCP	Master Arm switch	Set to ARM	
Font dash, MFCD	MFCD DSMS OSB	Press	
Front dash, MFCD	DSMS Status page	Press PROF OSB 1	
Front dash, MFCD	DSMS Profile Main page	Press OSB 19 and 20 to select profile	
Front dash, MFCD	DSMS Profile Main page	Press ACT PRO OSB 17	
Front dash, MFCD	DSMS Profile Main page	Press VIEW PRO OSB 3	
Front dash, MFCD	DSMS Profile Control page	Set release settings	
Front dash, MFCD	DSMS Profile Control page	Press CHG SET OSB 16	
Front dash, MFCD	DSMS Settings page	Set release settings	
Control stick	Master Mode Select Button	Cycle to CCIP or CCRP	Press Master Mode Select Button
HUD	HUD symbology	CCIP: align CCIP pipper over target and press and hold weapon release button . CCRP: Align reticle over ASL and hold weapon release button down.	Press Weapon Release Button
Illumination Flares			

Panel	Controls	Operation	Key commands
Left console, AHCP	Master Arm switch	Set to ARM	
Font dash, MFCD	MFCD DSMS OSB	Press	
Front dash, MFCD	DSMS Status page	Press PROF OSB 1	
Front dash, MFCD	DSMS Profile Main page	Press OSB 19 and 20 to select profile	
Front dash, MFCD	DSMS Profile Main page	Press ACT PRO OSB 17	
Front dash, MFCD	DSMS Profile Main page	Press VIEW PRO OSB 3	
Front dash, MFCD	DSMS Profile Control page	Set release settings	
Front dash, MFCD	DSMS Profile Control page	Press CHG SET OSB 16	
Front dash, MFCD	DSMS Settings page	Set release settings	
Control stick	Master Mode Select Button	Cycle to CCRP	Press Master Mode Select Button
HUD	HUD symbology	Align reticle over ASL and hold weapon release button down.	Press Weapon Release Button
CCIP Consent to Release (CR) Mode			
Front dash, AHCP	IFFCC switch	Set to TEST	
HUD	IFFCC Test Menu	Set CR option to 5 MIL or 3/9	
Front dash, AHCP	IFFCC switch	Set to ON	

Panel	Controls	Operation	Key commands
Left console, AHCP	Master Arm switch	Set to ARM	
Font dash, AHCP	MFC D DSMS OSB	Press	
Front dash, MFC D	DSMS Status page	Press PROF OSB 1	
Front dash, MFC D	DSMS Profile Main page	Press OSB 19 and 20 to select profile	
Front dash, MFC D	DSMS Profile Main page	Press ACT PRO OSB 17	
Front dash, MFC D	DSMS Profile Main page	Press VIEW PRO OSB 3	
Front dash, MFC D	DSMS Profile Control page	Set release settings	
Front dash, MFC D	DSMS Profile Control page	Press CHG SET OSB 16	
Front dash, MFC D	DSMS Settings page	Set release settings	
Control stick	Master Mode Select Button	Cycle to CCIP	Press Master Mode Select Button
HUD	HUD symbology	Align reticle over target and press and hold weapon release button	Press Weapon Release Button
HUD	HUD symbology	Maneuver aircraft such that solution cue passes through pipper	
Laser-Guided Bomb			
Front dash, AHCP	TGP switch	Set to ON	

Panel	Controls	Operation	Key commands
Front dash, AHCP	LASER switch	Set to ARM	
Front dash, MFCD	MFCD TGP OSB	Press	
Front dash, MFCD	TGP STBY page	Press A-G OSB 2 or A-A OSB 3 for Ground or Air modes	
Left console, throttle	Slew switch	Slew TGP line of sight over target	Move Slew Switch
Control stick	TMS Forward Long	Set as SPI	Press TMS Forward Long
Front dash, AHCP	Master Arm switch	Set to ARM	
Front dash, MFCD	MFCD DSMS OSB	Press	
Front dash, MFCD	DSMS Status page	Press PROF OSB 1	
Front dash, MFCD	DSMS Profile Main page	Press OSB 19 and 20 to select profile	
Front dash, MFCD	DSMS Profile Main page	Press ACT PRO OSB 17	
Front dash, MFCD	DSMS Profile Main page	Press VIEW PRO OSB 3	
Front dash, MFCD	DSMS Profile Control page	Set release settings	
Front dash, MFCD	DSMS Profile Control page	Press CHG SET OSB 16	
Front dash, MFCD	DSMS Settings page	Set release settings	
Control stick	Master Mode Select Button	Cycle to CCRP	Press Master Mode Select Button

Panel	Controls	Operation	Key commands
HUD	HUD symbology	Align reticle over ASL and hold weapon release button down.	Press Weapon Release Button
Control stick	Laser fire switch	Turn on Laser after bomb is released	Press Nosewheel Steering Button
Front dash, MFC	TGP	Maintain TGP line of sight to target during bomb time of flight	
IAM-Guided Bomb			
	Designation device	Set SPI using steerpoint, TDC, TGP, TAD or Maverick (TMS Forward Long)	
Left console, AHCP	Master Arm switch	Set to ARM	
Front dash, MFC	MFC DSMS OSB	Press	
Front dash, MFC	DSMS Status page	Press PROF OSB 1	
Front dash, MFC	DSMS Profile Main page	Press OSB 19 and 20 to select profile	
Front dash, MFC	DSMS Profile Main page	Press ACT PRO OSB 17	
Control stick	Master Mode Select Button	Cycle to CCRP	Press Master Mode Select Button

Panel	Controls	Operation	Key commands
HUD	HUD symbology	Align reticle over ASL and hold weapon release button down.	Press Weapon Release Button
Control stick	HUD symbology	Bomb will release when release cue is between max and min range carets on reticle.	
Maverick			
Left console, AHCP	Master Arm switch	Set to ARM	
Front dash, MFC	MAV OSB	Press	
Front dash, MFC	MAV page	Power ON Maverick, press OSB 6. 3 minute alignment	
Front dash, MFC	MFC DSMS OSB	Press	
Front dash, MFC	DSMS Status page	Press PROF OSB 1	
Front dash, MFC	DSMS Profile Main page	Press OSB 19 and 20 to select profile	
Front dash, MFC	DSMS Profile Main page	Press ACT PRO OSB 17	
Control stick	Master Mode Select Button	Cycle to CCIP	Press Master Mode Select Button

Panel	Controls	Operation	Key commands
HUD	HUD and MAV page	Slew tracking gate over target and release slew to initiate tracking	Move Slew Switch
Control stick	Weapon release button	Press with target lock indicated by steady Pointing Cross	Press Weapon release button

Aerial Refueling

Panel	Controls	Operation	Key commands
Left console, radios	Select tanker frequency	Inform of intent to refuel	
Front dash, AHCP	Master Arm switch	Set to SAFE	
Front dash, AHCP	GUN/PAC switch	Set to SAFE	
Front dash, AHCP	Laser switch	Set to SAFE	
Front dash, MFCD	Maverick page	Set EO power to OFF	
Left console, fuel panel	Fill disable switches	Set as needed	
Left console, Fuel panel	Tank Gate switch	Set to CLOSE	
Left console, Fuel Panel	Refueling door slipway lever	Set to OPEN	
Canopy bow	Refuel status lights	Confirm READY is illuminated	

Panel	Controls	Operation	Key commands
Left console, radios	Select flight frequency and set the formation to Echelon	Fly flight to pre-contact position in trail of tanker	
Left console, IFF panel	Master Mode dial	Set to STBY	
Left console, CMSP panel	Mode Select dial	Set to STBY	
Left console, Fuel Panel	Exterior Lighting dial	Set as desired	
Left console, radios	Select tanker frequency	Request contact	
Control stick Throttles	Stick and throttles	Close to contact position at 2-3 knots and establish contact position	
Canopy bow	Refuel status lights	Confirm LATCHED light when connected	
Control stick Throttles	Stick and throttles	Reduce power and pull back and down from tanker when fueling complete	
Canopy bow	Refuel status lights	Confirm DISCONNECT light	
Left console, fuel panel	Refueling door slipway lever	Set to CLOSE	
Control stick Throttles	Stick and throttles	Move to left wing of tanker	

Landing Preparations

Panel	Controls	Operation	Key commands
Front dash	Altimeter	Confirm that data is accurate	
Front dash, landing gear panel	Anti-Skid switch	Set to ANTI-SKID	
Front dash, landing gear panel	Landing lights switch	Set to LAND	
Front dash, fuel quantity panel	Fuel gauge	Confirm needed amount of fuel	
HUD	IFFCC Menu Display Options	Set to IAS	

Landing Approach

Panel	Controls	Operation	Key commands
TACAN Approach			
Front dash, navigation mode select panel	TCN (TACAN) button	Press	
Right console, TACAN panel	Channel frequency knobs	Set desired frequency of co-located airfield	

Panel	Controls	Operation	Key commands
Right console, TACAN panel	TACAN mode dial	Set to T/R	
Front dash, ADI	Bank Steering Bar	Center bar	
Front dash, HSI	Range Indicator	Monitor range to TACAN	
	Penetrate to TACAN location	Descend at 1,200 to 1,500 ft/min and 200 to 250 KIAS	
	Level Off	Level off at 400 ft and approach flat at 150 KIAS	
	Visually Spot and Land	Configure aircraft for landing and land	
ILS Approach			
Front dash, navigation mode select panel	ILS button	Press	
Right console, ILS panel	Channel frequency knobs	Set desired frequency of co-located airfield	
Front dash, ADI	Bank and Pitch Steering bars	Center the bars	
Front dash, HSI	CDI needle	Maintain centered CDI needle	

Panel	Controls	Operation	Key commands
	Approach	Start at 2,000 ft AGL and at 150 KIAS with bars centered	
	Outer Marker Beacon	Extend speedbrakes to 40%, lower gear, lower flaps to DN and on-speed AoA	
	Inner Marker Beacon	Short final and prepare for landing on glide slope	
	Land	Land aircraft	
GCA Approach			
Radio	Radio ATC	Request vectors to final	
	Approach	Land according to circle or straight in approach	
Circle Landing Approach			
	Downwind Leg	2,000 ft over runway at 250 KIAS at -300 feet for each mile traveled.	
	Base leg	Start base leg 60° bank turn when runway is 45 degrees off wing. 1,500 ft AGL and 150 KIAS	

Panel	Controls	Operation	Key commands
	Final Approach	Roll out from perch on final and configure for landing and maintain on-speed AoA -500 FPM	
	Land	Land aircraft	

Aircraft Shut Down

Panel	Controls	Operation	Key commands
Right console, environment control panel	Pitot Heat switch	Set to OFF	
Right console, lighting control panel	Light settings	Set Position lights to Flash, Signal lights to Bright, and Anti-Collision lights to OFF	
Left console, throttle quadrant	Speed brake lever	Close speed brakes	
Front dash	Wheel brake handle	Set brake	
Front dash, landing gear panel	Anti-skid switch	Set to OFF	
Right console	Canopy switch	Open	
Right console, TACAN panel	TACAN mode dial	Set to OFF	
Right console, ILS panel	ILS power control knob	Set to OFF	

Panel	Controls	Operation	Key commands
Front dash, AHCP	IFFCC switch	Set to OFF	
Front dash, AHCP	CICU switch	Set to OFF	
Front dash	MFCDS	Set both to OFF	
Front dash, landing gear panel	Landing / Taxi light switch	Set to OFF	
Right console, countermeasure panel	Mode dial	Set to OFF	
Left console, throttle quadrant	Flap lever	Set to UP	
Right console, AAP	EGI switch	Set to OFF	
Right console, AAP	CDU switch	Set to OFF	
Front dash, TISL panel	Mode dial	Set to OFF	
Left console, throttle quadrant	Left engine throttle	Set to OFF after 5 minutes at IDLE	
Left console, throttle quadrant	Right engine throttle	Set to OFF after 5 minutes at IDLE	
Right console, electrical panel	Inverter switch	Set to OFF	
Right console, electrical panel	Battery switch	Set to OFF	
Left console, radio panels	VHF 1, VHF 2 and UHF radios	Turn off	

RADIO COMMUNICATIONS



RADIO COMMUNICATIONS

As with DCS: Black Shark, the radio communications window is accessed by a press of the \ backslash key (this is for US keyboards, other language keyboards may vary). Upon doing so, the list of radio command recipients is displayed along with the function (Fx) key required to view its sub-command window. For example: if you want to access the JTAC radio commands, you would press the F4 key. When in radio command mode, the function key views are disabled.

You also have the option to use the Mic Switch to select radios:

- Mic switch forward: VHF AM radio
- Mic switch aft: VHF FM radio
- Mic switch up: No function
- Mic switch down: UHF radio

There are two optional modes of using the radio that depend on the "EASY COMMUNICATION" OPTION under the GAMEPLAY tab.

Easy Communication is enabled. When the radio menu is displayed, recipients are color-coded as follows:

Recipients on which at least one of the radios is tuned to are colored white.

Recipients on which at least one of the radios can be tuned to, but are not currently on the correct frequency, are colored gray.

Recipients that cannot be contacted due to range or terrain masking / earth curvature are colored black.

Each will also have their modulation / frequency listed. When you select a recipient, the appropriate radio will automatically be tuned to communicate with the selected recipient.

After a recipient has been selected to communicate with, the appropriate radio will be automatically tuned to the correct frequency.

Using the Mic switch, recipients will be color-coded according to their being on the same modulation as the selected radio.

Easy Communication is not enabled. When recipients are displayed, there is no color-coding of availability and no listing of their modulation / frequency. This is the more realistic mode and requires you to know the correct modulation / frequencies for each recipient and you must manually enter the frequencies on the correct radio.

Top Level Recipient List

If using "Easy Communications", recipients not present in the mission will not be listed.

- F1. Wingman...**
- F2. Flight...**
- F3. Second Element...**
- F4. JTACs...**
- F5. ATCs...**
- F6. Tankers...**
- F7. AWACs...**
- F8. Ground Crew...**
- F10. Other...**
- F12. Exit**

Hot keys will also be available to directly issue any command in the structure. These can be found in Input Options.

To exit radio communications, you can also press the **ESC** key.

F1 Wingman

Upon selecting F1 Wingman from the main radio communications window, you have the option to select the basic type of message you wish to send to your number 2 wingman. These are:

- F1. Navigation...**
- F2. Engage...**
- F3. Engage with...**
- F4. Maneuvers...**
- F5. Rejoin Formation**
- F6. Out**
- F11. Previous Menu**

F12. Exit

F1 Navigation...

The Navigation options allow you to direct where your wingman will fly to.

F1 Anchor Here. Your wingman will orbit at its current location until you issue a Rejoin command.

F2 Return to base. Your wingman will return to and land at the airbase designated in the flight plan.

F3 Fly to My SPI. Your wingman will fly to the location of your SPI and orbit there until told to do otherwise.

F4 Fly to My steerpoint. Your wingman will fly to your steerpoint and orbit there until you tell him or her to do otherwise.

F5 Fly to Tanker. If available, your wingman will rendezvous with the nearest tanker and refuel. Once complete, the flight will rejoin with you.

F11 Previous Menu

F12 Exit

F2 Engage...

The Engage options allow you to direct your wingman to attack a specific type of target. After issuing the order, the wingman will attempt to locate the specified target type and attack it.

F1 Engage Ground Targets. Wingman will attack any enemy ground unit it can locate.

F2 Engage Armor. Wingman will attack any tanks, infantry fighting vehicles, and armored personnel carriers it can locate.

F3 Engage Artillery. Wingman will attack any tube artillery or multiple rocket launchers that it can locate.

F4 Engage Air Defenses. Wingman will attack any enemy anti-aircraft artillery and surface to air missile units that it can locate.

F5 Engage Utility Vehicles. Wingman will attack all supply, transport, fuel, power generation, command and control, and engineering units it can locate.

F6 Engage Infantry. Wingman will attack hostile infantry units. Note that the infantry units are very difficult to detect unless they are moving or firing weapons.

F7 Engage Ships. Wingman will engage enemy surface combatants. Note that most surface combatants are heavily armed and that the A-10C is not well-suited to attacking such targets.

F8 Engage Bandits. Wingman will engage enemy any fixed-wing and rotary-wing aircraft it can locate. Note that the A-10C is not best suited to air-to-air combat and such an order should be a last resort when confronted with enemy fighters.

F11 Previous Menu

F12 Exit

F3 Engage With...

Whereas the F2 Engage command allows you to give basic orders for your wingman to attack a target type, the F3 Engage With set of commands not only allows you to determine target type, but also the direction of attack and what weapon type to use. This is done in a tiered manner by first selecting target type, then weapon type, and finally the attack heading. The wingman will then attempt to locate targets of the specified type at your SPI location and attack them according to your specified weapon and attacking heading. While the F2 Engage options are fast to issue, the F3 Engage With options provides much greater control.

Target Type

F1 Engage Ground Targets. Wingman will attack any enemy ground unit it can locate.

F2 Engage Armor. Wingman will attack any tanks, infantry fighting vehicles, and armored personnel carriers it can locate.

F3 Engage Artillery. Wingman will attack any tube artillery or multiple rocket launchers that it can locate.

F4 Engage Air Defenses. Wingman will attack enemy anti-aircraft artillery and surface to air missile units that it can locate.

F5 Engage Utility Vehicles. Wingman will attack all supply, transport, fuel, power generation, command and control, and engineering units it can locate.

F6 Engage Infantry. Wingman will attack hostile infantry units. Note that the infantry units are very difficult to detect unless they are moving or firing weapons.

F7 Engage Ships. Wingman will engage enemy surface combatants. Note that most surface combatants are heavily armed and that the A-10C is not well-suited to attacking such targets.

Weapon Type

Once you have selected the target type, you will be given a list of weapon types that you want your wingman to engage the target with. These include:

F1 Missile... This includes the type of AGM-65 Maverick your wingman is carrying.

F2 Unguided Bomb... This includes bombs such as Mk-82, Mk-82AIR, Mk-84, CBU-87, and CBU-97.

F3 Guided Bomb... This includes such bombs as GBU-10, GBU-12, GBU-31, GBU-38, CBU-103, and CBU-105.

F4 Rocket... This includes the type of rockets that your wingman is carrying with explosive warheads.

F5 Marker... This includes the type of rockets that your wingman is carrying with white phosphorus (WP) warheads.

F6 Gun... Your wingman will use its GAU-8/A cannon.

Attack Heading

After you've selected the weapon type for your wingman to use, the third and final step is to determine the attack heading that you wish your wingman to use. This can be useful to help it avoid overflying enemy defenses. The options include:

F1 Default. Wingman will use the most direct heading to attack the target.

F2 North. Wingman will attack the target from south to north.

F3 South. Wingman will attack the target from north to south.

F4 East. Wingman will attack the target from west to east.

F5 West. Wingman will attack the target from east to west.

F4 Maneuvers...

Although your wingman will generally do a good job of knowing when and how to maneuver, there may be times when you want to give him/her a very specific maneuvering order. This could be in response to a threat like an incoming SAM, or to better set up an attack.

F1 Break Right. This command will order your wingman to make a maximum-G break to the right.

F2 Break Left. This command will order your wingman to make a maximum-G break to the left.

F3 Break High. This command will order your wingman to make a maximum-G break high.

F4 Break Low. This command will order your wingman to make a maximum-G break low.

Note: The Break orders are most often a last-ditch evasive maneuver to a threat. You generally want your wingman to break into the missile 3 or 4 seconds before the missile will impact. This will hopefully force the missile to pull more G than it can generate and thus fall behind your wingman. During a break call, your wingman will also automatically expend chaff and flares.

F5 Crank Right. Flight stabilizes hostiles at 60 degrees right aspect.

F6 Crank Left. Flight stabilizes hostiles at 60 degrees left aspect.

F7 Clear Right. Your wingman will perform a 360° turn to the right of the current flight path while searching for targets.

F8 Clear Left. Your wingman will perform a 360° turn to the left of the current flight path while searching for targets.

F9 Pump. Your wingman will perform a 180° turn from its current heading and fly 10 nm. Once reached, it will turn 180° back to the original heading.

F5 Rejoin Formation

Issuing this command will instruct your wingman to cease its current task and rejoin formation with you.

F6 Out

This command will cause your wingman to execute a maximum performance "out" maneuver (180°) to put threats on their six and to maintain formation with player or to rejoin. This command must override all other AI logic (for example threat reactions).

F2 Flight

Upon selecting **F2 Flight** from the main radio communications window, you have the option to select the basic type of message you wish to send. These are:

- F1 Navigation...**
- F2 Engage...**
- F3 Engage with...**
- F4 Maneuvers...**
- F5 Formation**
- F6 Rejoin Formation**
- F7 Fence In**
- F8 Fence Out**
- F11 Previous Menu**
- F12 Exit**

F1 Navigation...

The Navigation options allow you to direct your flight where to fly to.

- F1 Anchor Here**
- F2 Return to base**
- F3 Fly to My SPI**
- F4 Fly to My steerpoint**
- F5 Fly to Tanker**
- F11 Previous Menu**
- F12 Exit**

These commands mirror those of the Wingman Navigation commands but apply to all flight members.

F2 Engage...

The Engage options allow you to direct your flight to attack a specific type of target. After issuing the order, the flight will attempt to locate the specified target type and attack it.

F1 Engage Ground Targets

F2 Engage Armor

F3 Engage Artillery

F4 Engage Air Defenses

F5 Engage Utility Vehicles

F6 Engage Infantry

F7 Engage Ships

F8 Engage Bandits

F11 Previous Menu

F12 Exit

These commands mirror those of the Wingman Engage commands but apply to all flight members.

F3 Engage With...

These commands mirror those of the Wingman Engage With commands but apply to all flight members. These commands work the same as the Wingman Engage With commands described above.

F4 Maneuvers...

F1 Break Right

F2 Break Left

F3 Break High

F4 Break Low

F5 Crank Right

F6 Crank Left

F7 Clear Right

F8 Clear Left

F9 Pump

F11 Previous Menu

F12 Exit

These commands mirror those of the Wingman Maneuvers commands but apply to all flight members.

F5 Formation

From the Formation menu, you can select the formation that the flight will fly in relation to you as the flight leader.

F1 Go Line Abreast**F2 Go Trail****F3 Go Wedge****F4 Go Echelon Right****F5 Go Echelon Left****F6 Go Finger Four****F7 Go Spread Four****F8 Float Formation****F9 Tighten Formation****F11 Previous Menu****F12 Exit**

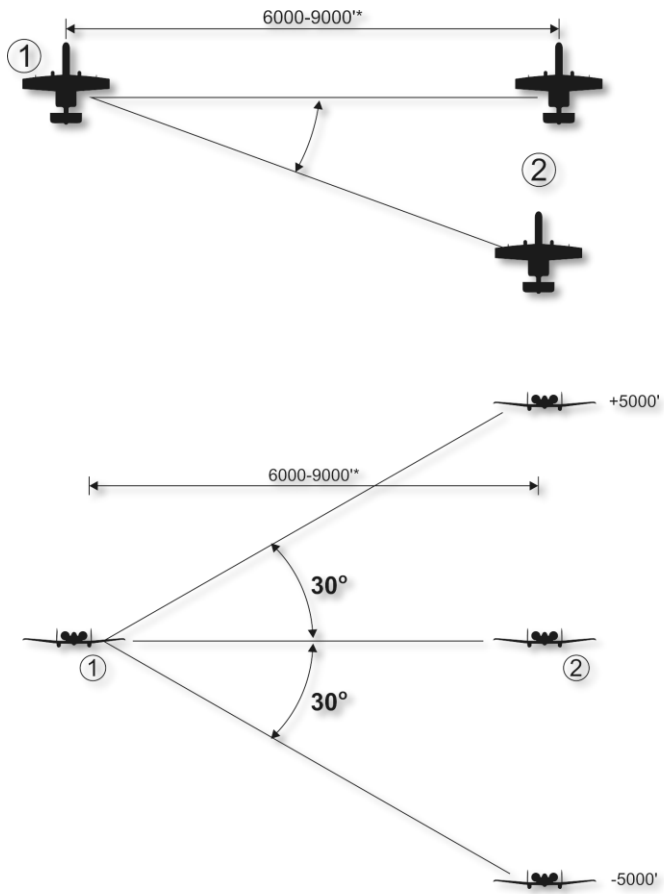

Figure 495: F1 Go Line Abreast



Figure 496: F2 Go Trail

Position may be modified within a 4000-12,000' envelope by flight lead.

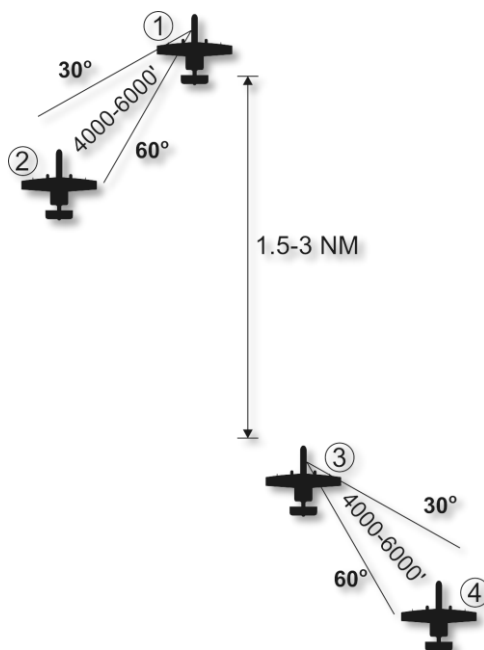

Figure 497: F3 Go Wedge

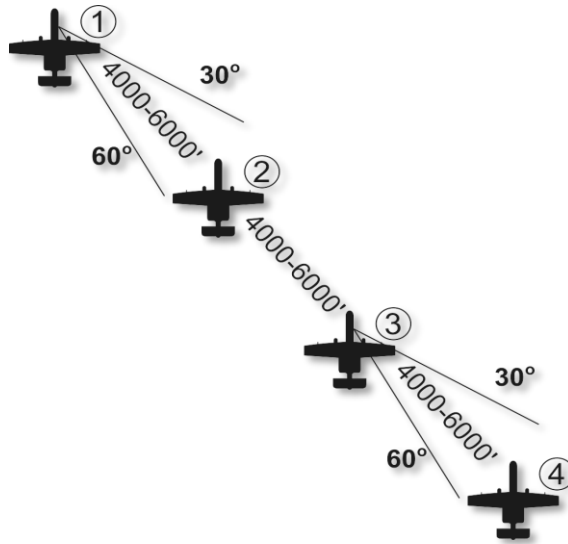

Figure 498: F4 Go Echelon Right

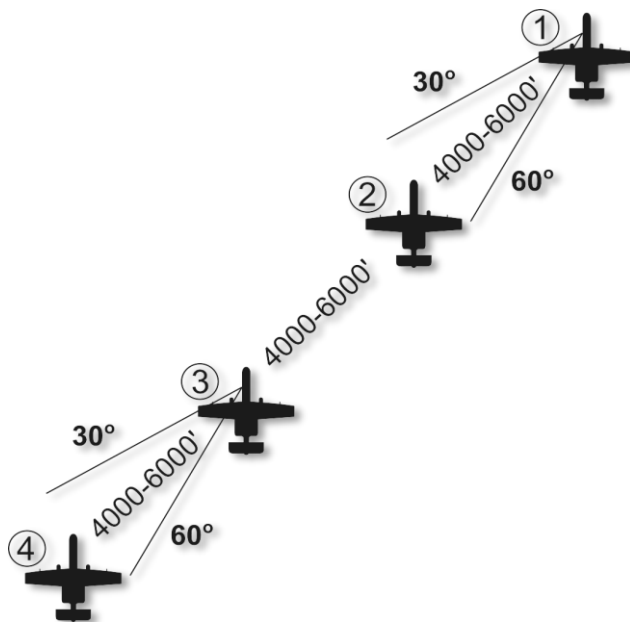

Figure 499: F5 Go Echelon Left

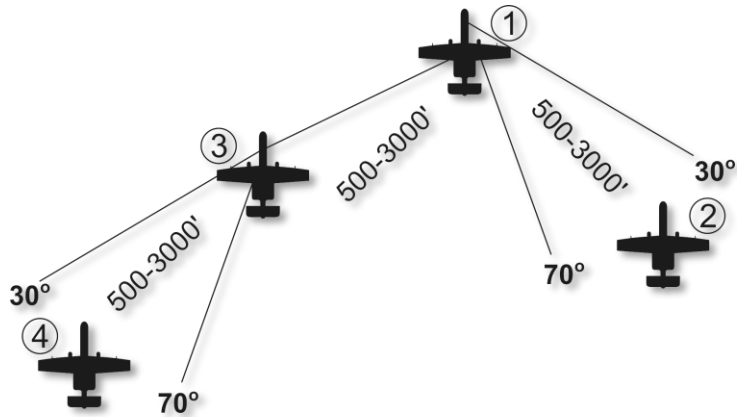

Figure 500: F6 Go Finger Four

Position may be modified within a 4000-12,000' envelope by flight lead.

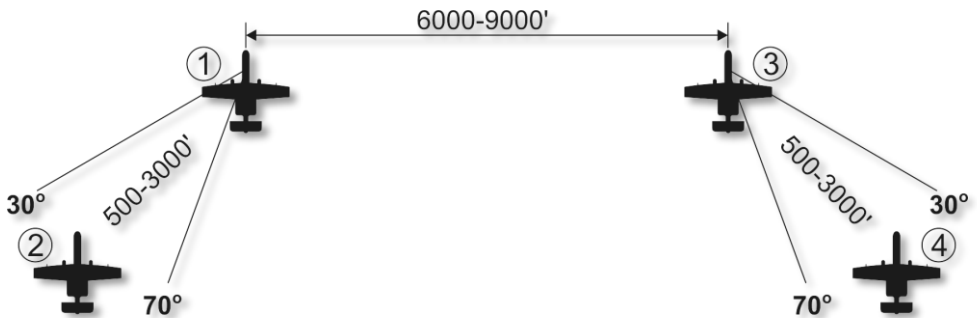

Figure 501: F7 Go Spread Four

Position may be modified within a 4000-12,000' envelope by flight lead.

F8. Float Formation. Increase the distance between each aircraft in the current formation.

F9. Tighten Formation. Decrease the distance between each aircraft in the current formation.

F6 Rejoin Formation

Issuing this command will instruct your flight to cease their current task and rejoin formation with you.

F7 Fence In

Flight will turn off navigation and collision lights and enable ECM.

F8 Fence Out

Flight will turn on navigation and collision lights and disable ECM.

F3 Second Element

Upon selecting F3 Second Element from the main radio communications window, you have the option to select the basic type of message you wish to send to the second element of your flight. The second element consists of flight members 3 and 4 with number 3 being the element lead. When issuing a command to Second Element, number 3 and 4 carry out the order jointly. These commands are:

F1 Navigation...

F2 Engage...

F3 Engage with...

F4 Maneuvers...

F5 Rejoin Formation

F6 Out

F11 Previous Menu

F12 Exit

F1 Navigation...

The Navigation options allow you to direct your second element where to fly to.

F1 Anchor Here

F2 Return to Base

F3 Fly to My SPI

F4 Fly to My steerpoint

F5 Fly to Tanker
F11 Previous Menu
F12 Exit

These commands mirror those of the Wingman Navigation commands but apply to the second element.

F2 Engage...

The Engage options allow you to direct your second element to attack a specific type of target. After issuing the order, the wingman will attempt to locate the specified target type and attack it.

F1 Engage Ground Targets
F2 Engage Armor
F3 Engage Artillery
F4 Engage Air Defenses
F5 Engage Utility Vehicles
F6 Engage Infantry
F7 Engage Ships
F8 Engage Bandits
F11 Previous Menu
F12 Exit

These commands mirror those of the Wingman Maneuvers commands but apply to the second element.

F3 Engage with...

These commands mirror those of the Wingman Maneuvers commands but apply to the second element.

F4 Maneuvers...

Although your second element will generally do a good job of knowing when and how to maneuver, there may be times when you want to give him/her a very specific maneuvering order. This could be in response to a threat like an incoming SAM, or to better set up an attack.

F1 Break Right
F2 Break Left
F3 Break High

F4 Break Low
F5 Crank Right
F6 Crank Left
F7 Clear Right
F8 Clear Left
F9 Pump
F11 Previous Menu
F12 Exit

These commands mirror those of the Wingman Maneuvers commands but apply to the second element.

F5 Rejoin Formation

Issuing this command will instruct your second element to cease its current task and rejoin formation with you.

F6 Out

This command will cause your second element to execute a maximum performance "out" maneuver (180°) to put threats on their six and to maintain formation with player or to rejoin. This command must override all other AI logic (for example threat reactions).

Flight Member Responses

After sending a radio message to any of your flight members, you will have one of two responses:

- **Flight number of responder (2, 3, or 4).** When a flight member will carry out the order, it will respond simply with its flight number.
- (Flight member number) **unable.** When a flight member cannot carry out the order, it will respond with its flight number following by "unable". For example: "2, unable"

F4 JTAC

The Joint Terminal Attack Controller (JTAC) is one of your most valuable tools for locating targets. Formerly known as Forward Air Controller (FAC), the JTAC is generally a ground force element assigned to coordinate Close Air Support (CAS) with friendly ground forces. The JTAC has a variety of methods to mark targets for you that depend on line of sight, time of day, weapon to be used, and proximity of attack to friendly forces. These include coordinates, smoke, laser designation, IR pointer, and SA Link.

Depending on the battlefield situation, the level of JTAC control of the attack may vary. There are three types of terminal attack control:

- **Type 1:** JTACs use Type 1 control when the risk assessment requires them to visually acquire the attacking aircraft and the target under attack. This is the most common and restrictive of the three types. Type 1 is most often used when friendly forces are “danger close”.
- **Type 2:** Type 2 control will be used when the JTAC desires control of individual attacks but assesses that either visual acquisition of the attacking aircraft or target at weapons release is not possible or when attacking aircraft are not in a position to acquire the mark/target prior to weapons release/launch.
- **Type 3:** Type 3 control may be used when the tactical risk assessment indicates that CAS attack imposes low risk of fratricide. This is the least restricted control type.

In order to communicate with a JTAC, there must be at least one in the mission. Any unit can be assigned as a JTAC (including aircraft like a Predator), but units that have night vision and laser designation are most often used. JTACs are assigned a radio frequency that they need to be contacted on. This is most often done over the VHF FM radio.

JTAC Engagement Flow

To contact a JTAC, either select the main radio menu (****) or the Mic switch in the direction of the appropriate radio (most often the Mic switch Aft for VHF FM). Press **F4** to select JTACs from the Radio Main Menu.

After selecting “JTACs”, a list of JTACs in the mission will be displayed, along with their frequencies and callsigns (if using Easy Communications). Select the JTAC that you wish to contact. If you are using realistic radio, you will need to ensure that the correct radio is tuned to the correct frequency that the JTAC is on (most often listed in Mission Briefing). If using Easy Communications, the correct

radio and frequency will be set automatically. You will then be prompted to Check-in with the estimated time you will be available for tasking (Play Time).

When you check-in, you will automatically radio the JTAC key information that includes:

- Your mission number
- Location from Initial Point (IP) and your altitude
- What you are armed with
- How long you are available (hours + minutes)

You will then automatically ask what tasking the JTAC has for you.

After a pause, the JTAC will reply with the terminal control type (1, 2 or 3) that will be used and then ask if you are available for the 9-line. The 9-line is a standard briefing form that provides the pilot key information to prosecute the attack. When you are ready, press the **** key to view the radio menu and then press **F1 Ready to copy**.

The JTAC will now read the 9-line as follows:

1. The Initial Point (IP) that the attack should be started from. This is a point created in the Mission Editor and is a NAV point in the CDU
2. Attack heading to the target and any offset needed
3. Distance to target
4. Elevation of target (MSL)
5. Target type
6. UTM coordinates of target
7. How the target is marked (None, White Phosphorus (WP), Laser, or IR Pointer)
8. Location of nearby friendly ground forces
9. Control point to egress to

After completing the 9-line, the JTAC will automatically ask if you are ready for remarks. Remarks are additional information not included in the 9-line. When ready, press **** and then **F1**. The JTAC will then radio the remarks, that generally include the weapon to use, weather information, and/or attack headings.

You will now need to read back the target location and elevation, and other data if applicable such as final attack heading. To do so, press **** and then **F1**.

With the read back complete, the JTAC will message "Standby for data". Soon after you will receive a text message digital 9-line on your MSG page and a small, red triangle will appear on the TAD at the target location. You can then use the TAD cursor to make this new symbol your SPI. To accept the tasking, press the WILCO OSB.

At this point, the engagement can vary according to how the JTAC designates the target: Coordinate, smoke, laser, or IR pointer. We'll discuss each of these separately:

Coordinate Only Designation

When the JTAC does not have line of sight to the target (often the case with Type 2 and 3), it will only be able to designate the target as a MGRS coordinate. The easiest way to target the coordinate is to make the red triangle data link symbol on the TAD your SPI. You can also create a new waypoint using the coordinate and select it as a Mission point from the CDU.

After receiving the point data, the JTAC will clear you to engage.

After your attack is complete, press **** and press **F1 Attack Complete**.

Smoke Designation

After receiving the point data, the JTAC will ask you to report when you are IP inbound. When you are ready to proceed from the IP to the target, press **** and **F1 IP Inbound** to start your attack. If you are inbound from the IP, the JTAC will then tell you to continue.

At this point, you need to wait for the JTAC to mark the target with smoke. When you are within 10 nm of the target, the target will be marked with white smoke and the JTAC will radio that the "mark is on the deck". Once you have a visual on the smoke, press **** and then **F1 Contact the Mark**. The JTAC will then radio back the location of the target from the smoke marker.

Once heading toward the target, press **** and then **F1 In** to indicate that you've started your attack run. If all looks good to the JTAC, he will clear you in hot. If not, he will abort the attack. Once you have released your weapon, press **** and then **F1 Off**.

Depending on the results of your attack, you will either be cleared to re-attack or cleared to depart. If cleared to re-attack, you need to start the process again from the IP Inbound stage of the attack.

Laser Designation

If the JTAC has tasked you to use GBU-10 or GBU-12 laser-guided bombs on the target, it will laser designate the target for you. During the 9-line, the laser code that you should search for is listed (1688 as default).

After receiving the point data, the JTAC will ask you to report when you are IP inbound. When you are ready to proceed from the IP to the target, press **** and **F1 IP Inbound** to start your attack. If you are inbound from the IP, the JTAC will then tell you to continue.

At this point, you'll tell the JTAC to lase the target by pressing **** and then **F1 Laser On**.

To locate the designation, slew the TGP to the target point and perform an LSS/LST search. When you have detected the designation, press **** and **F1 Spot**. You could also press **F3** to "Shift" the designation to a different target in the group, or "Terminate" the attack.

With the designated target in LST, set it as your SPI and attack using standard LGB delivery steps. As you are running in, press **** and **F1 In**. If all looks good to the JTAC, he will clear you in hot. If not, he will abort the attack. Once you have released your weapon, press **** and then **F1 Off**.

Depending on the results of your attack, you will either be cleared to re-attack or cleared to depart. If cleared to re-attack, you need to start the process again from the IP Inbound stage of the attack.

IR Pointer Designation

The IR Pointer, or IR Wand, replaces the smoke marker during low light conditions. To see the IR Pointer, you must have the Night Vision Goggles (NVG) on. The IR pointer appears as a line between the JTAC and the target.

As such, the process flow for the IR Pointer is the same as for the smoke marker. The only difference are the options for "Pulse" and "Rope" that instruct the JTAC to flash the IR Pointer on and off or move it around, respectively.

Other JTAC Radio Options

During a JTAC directed attack, the JTAC menus allow some additional options not mentioned above. These include:

- **Repeat Brief.** JTAC will repeat the 9-line briefing.
- **What is my target?** JTAC will repeat the type of target that you are tasked to destroy.
- **Contact.** This command is made to the JTAC to verify that the correct target is at the SPI location. You will report contact and provide a target description and MGRS coordinates. The JTAC will respond with a positive acknowledgment or with warning about contacting the wrong target. In its response, the JTAC also provide directions to the correct target.
- **Request BDA.** JTAC will update you on the status of the directed target.

- **Unable to comply.** Informs the JTAC that you are unable to carry out the instructed task.
- **Check Out.** Ends JTAC control.

F5 ATC

The Air Traffic Control (ATC) system of this simulation is context sensitive to the location of your aircraft: on the parking ramp or runway/airborne.

ATC VHF AM Contact Frequencies

- Anapa-Vityazevo: 121.0 MHz
- Batumi: 131.0 MHz
- Gelendzhik: 126.0 MHz
- Gudauta: 130.0 MHz
- Kobuleti: 133.0 MHz
- Kopitnari: 134.0 MHz
- Krasnodar Center: 122.0 MHz
- Krasnodar-Pashkovsky: 128.0 MHz
- Krymsk: 124.0 MHz
- Maykop-Khanskaya: 125.0 MHz
- Mineralnye Vody: 135.0 MHz
- Mozdok: 137.0 MHz
- Nalchik: 136.0 MHz
- Novorossiysk: 123.0 MHz
- Senaki-Kolkhi: 132.0 MHz
- Sochi-Adler: 127.0 MHz
- Soganlug: 139.0 MHz
- Sukhumi-Babushara: 129.0 MHz
- Tbilisi-Lochini: 138.0 MHz
- Vaziani: 140.0 MHz
- Beslan: 141.0 MHz

Tip: You can also find the ATC frequencies of the nearest airfields to you by selecting the DIVERT page from the CDU. If the airfield supports it, it will also list ILS and TACAN data.

Parking Ramp Start

Before you can communicate with ATC/Ground Control to get permission to start your engines, you first need to have your VHF AM radio up and running. To do so, you must first have the APU and APU Generator running, and the VHF AM radio turned on. Set the radio to the frequency of the airfield you are starting from.

With the radio now operating, press **** to bring up the radio menu and then press **F1 Request Engine Start** if using the Easy Communication option. If not using Easy Communications, press forward on the Mic switch (activate VHF AM radio), and select "Request Engine Start".

If you have wingmen, they will also now start their engines.

After the aircraft has been started and configured, select **F1 Request Taxi to Runway**. Once you receive permission, you can taxi to the "hold short" area of the taxiway - the area on the taxiway just short of entering the runway.

If you have wingmen, they will also now taxi to the runway.

When at the hold short area, press **** and **F1 Request Takeoff**. When permission is granted, you can taxi on to the runway and takeoff.

Runway and Air Start

If you are not starting from the parking ramp, you can access ATC by either pressing the **** key or the VHF AM Mic switch. Upon doing so, you can select **F5 ATCs**.

If you are using "Easy Communications", a list of airfield ATCs are listed along with their contact frequencies. Select the airfield ATC you wish to contact. If not using Easy Communications, you will first need to enter the ATC frequency of the airfield you wish to land on the VHF AM radio.

Once the airfield ATC is selected, you can either send them an "Inbound" message to indicate that you intend to land there, or a "Request Azimuth" (formerly: "I'm lost") message that will result in the ATC providing you guidance to reach the airfield.

When you select "Inbound", the ATC will respond with the following information:

- Heading to fly to reach landing initial point.
- Range to landing initial point.
- The QFE, or atmospheric pressure at the airfield elevation.
- Which runway to land on.

You can then radio:

- "Request landing" indicates your intent to land at directed runway.
- "Abort landing" indicates that you will not be landing at the directed runway.
- "Request Azimuth" requests navigation assistance to reach the airfield.

If you've requested landing and are on final approach, radio request landing a second time and ATC tower control will provide permission if the runway is clear. It will also provide wind direction and speed.

After you have landed, proceed to the parking area and shut down the aircraft.

F6 Ground Crew

After landing at a friendly airfield and taxiing to a parking ramp, you can communicate with the ground crew for rearming and refueling.

Prior to communications though, you will need to rotate the INT (intercom) dial clockwise on the Intercom Control Panel to enable communications with the ground crew. You will also need to press the HM (hot mic) button on the panel to initiate communications with the ground crew.

Once the intercom panel has been set up correctly, you can press **F8** to display the Ground Crew options.

F7 AWACS

After selecting the F7 AWACS option from the main radio menu, a list of all friendly AWACS in the mission will be listed, along with their VHF AM contact frequencies. Upon setting your VHF AM radio accordingly and contacting the desired AWACS, you'll be given the following options:

F1 Vector to bullseye. Sending this request to AWACS will result in AWACS providing you heading and range to the bullseye/anchor point set for the mission.

F2 Vector to home plate. Sending this request to AWACS will result in AWACS providing you heading, range, and the ATC frequency of the mission specified landing airbase.

F3 Vector to tanker. Sending this request to AWACS will result in AWACS providing you heading, range, altitude to the nearest KC-135 tanker.

F4 Request bogey dope. AWACS will provide heading, altitude, and aspect of the nearest enemy aircraft.

F5 Request Picture. Sending this request to AWACS will result in AWACS providing you bearing, range, and altitude of known enemy air threats.

The AWACS response differs according to the range of enemy air groups:

- **If BULL (over 50 nm):** (Your flight's callsign), (AWACS callsign), new picture, <number of groups detected> groups. First group, bulls <bearing> for <range>, <altitude band>. Second group, bulls <bearing> for <range>, <altitude>. (repeats up to three groups)
- **If BRA (under 50 nm):** (Your flight's callsign), (AWACS callsign), new picture, <number of groups detected> groups. First group, bra <bearing> for <range>, hits <altitude band>. Second group, bra <bearing> for <range>, hits <altitude band>. (repeats up to three groups)

F9 Tanker

To aerial refuel from a friendly KC-135 tanker, you will first need to contact it over the VHF AM radio. After selecting the F9 Tanker option, a list of tankers in the mission will be displayed with their contact frequencies (if using Easy Communications).

After contacting the desired tanker, follow on-screen directions from the tanker to refuel.

Radio Frequencies

In order to receive radio communications from other mission entities and have your transmitted messages received, it is vital that you have your radios set up properly! If not, you will be essentially talking to yourself.

When a mission is created, each friendly flight and airfield is provided a VHF AM and UHF frequency. These are generally noted in the mission briefing and should be set to your radios at the start of the missions. Generally, the following rules apply:

Your flight is most often assigned a UHF frequency. You will use this channel for inter-flight communications.

Other friendly flights operate on a common VHF AM frequency assigned to the operating area. When set correctly, you will hear radio communications from other flights operating in the area.

- AWACS is assigned a unique VHF AM frequency.
- The JTAC is most often assigned a unique VHF FM frequency.
- Each airbase ATC is assigned a unique VHF AM frequency.

As such, you may have to juggle multiple frequencies during a mission and the frequency preset features on the radio will become a big help.

SUPPLEMENTS

80605

RESCUE MANUAL CANOPY
RELEASE HANDLE

DANGER
EJECTION
SEAT
DANGER

SUPPLEMENTS

Morse Code Alphabet

MORSE CODE	ALPHABET
· —	A
— ···	B
— · — ·	C
— · ·	D
·	E
·· — ·	F
— — ·	G
····	H
··	I
· — — —	J
— · —	K
· — · ·	L
— —	M
— ·	N
— — —	O
· — — ·	P
— — · —	Q
· — ·	R
·· ·	S
—	T
·· —	U
·· · —	V
· — —	W

MORSE CODE	ALPHABET
— · · —	X
— · — —	Y
— — · ·	Z

MORSE CODE	DIGITS FULL
· — — — —	1
· · — — —	2
· · · — —	3
· · · · —	4
· · · · ·	5
— · · · ·	6
— — · · ·	7
— — — · ·	8
— — — — ·	9
— — — — —	0

MORSE CODE	PUNCTUATION MARKS
· — · — · —	Period
— · — · — ·	Semicolon
— — — · · ·	Colon
— · — · — —	Exclamation mark
· · — — · ·	Question mark
· — · · · ·	Quotation mark
— — · · — —	Comma
— · — — ·	Parenthesis open
— · — — · —	Parenthesis closed

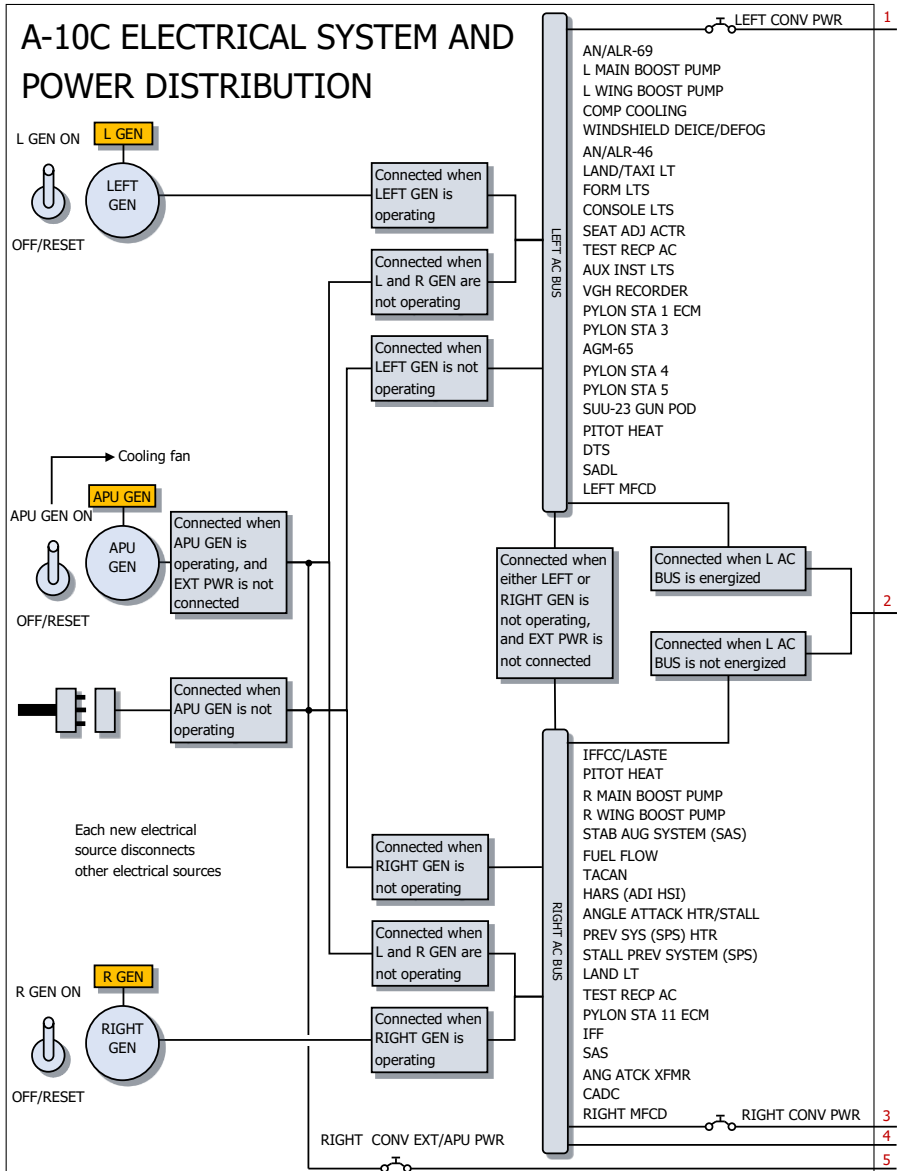

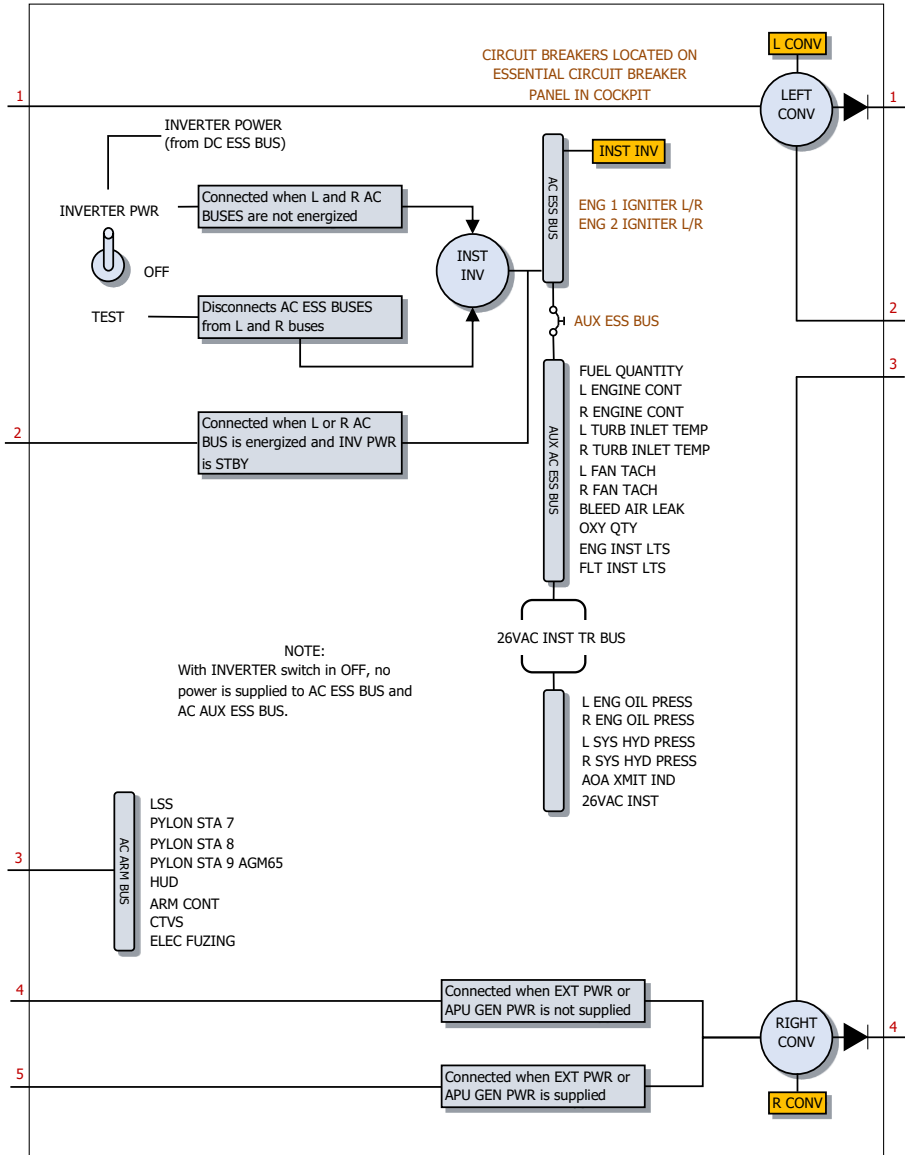

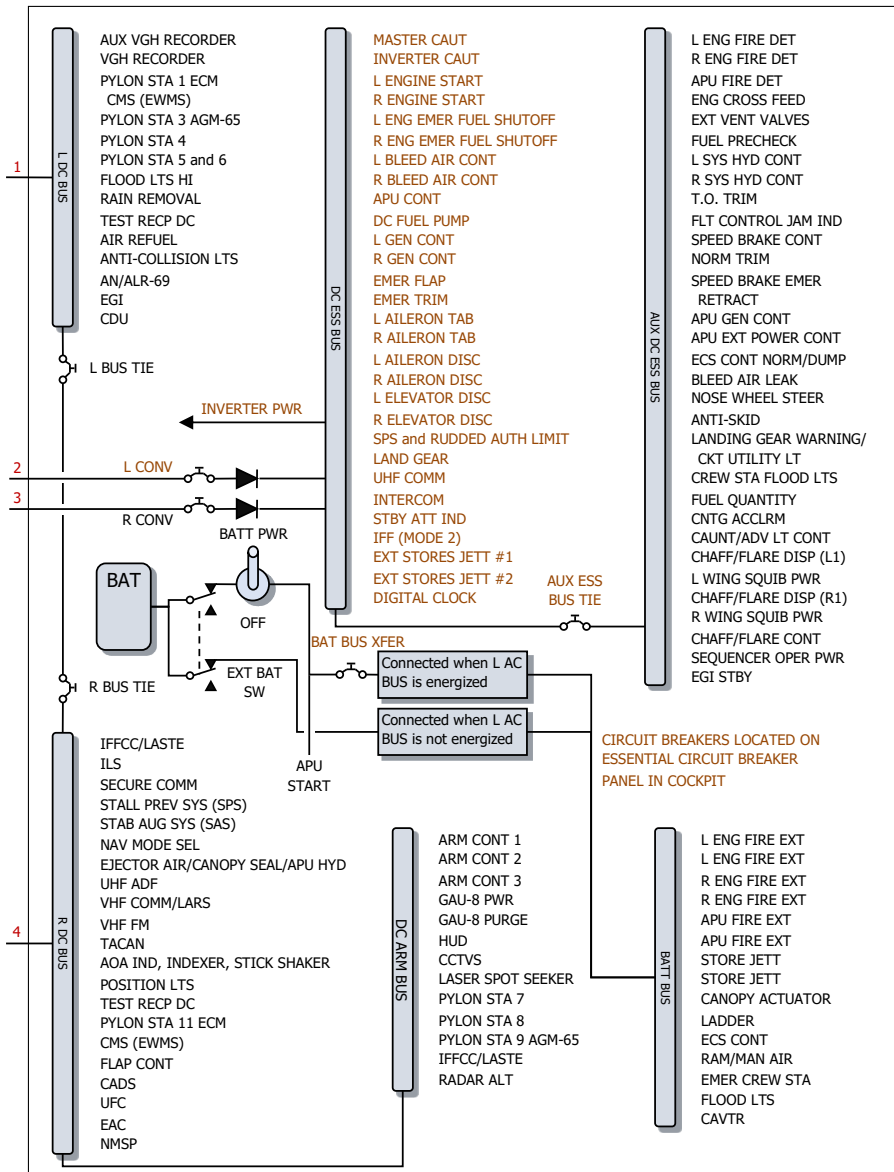

Aerodrome Data

AIRDROME	RUNWAY	TACAN, CHANNEL	ILS	TOWER COMM
UG23 GUDAUTA (ABKHAZIA)	15-33, 2500m			130.0
UG24 SOGANLUG (GEORGIA)	13-31, 2400m			139.0
UG27 VAZIANI (GEORGIA)	14-32, 2500m	22X (VAS)	108.75	140.0
UG5X KOBULETI (GEORGIA)	07-25, 2400m	67X (KBL)	07 ILS - 111.5	133.0
UGKO KOPITNARI (GEORGIA)	08-26, 2500m	44X (KTS)	08 ILS - 109.75	134.0
UGKS SENAKI - KOLKHI (GEORGIA)	09-27, 2400m	31X (TSK)	09 ILS - 108.9	132.0
UGSB BATUMI (GEORGIA)	13-31, 2400m	16X (BTM)	13 ILS - 110.3	131.0
UGSS SUKHUMI - BABUSHARA (ABKHAZIA)	12-30, 2500m			129.0
UGTB TBILISI - LOCHINI (GEORGIA)	13-31, 3000m		13 ILS - 110.3 31 ILS - 108.9	138.0
URKA ANAPA - VITYAZEVO (RUSSIA)	04-22, 2900m			121.0
URKG GELENDZHIK (RUSSIA)	04-22, 1800m			126.0
URKH MAYKOP - KHANSKAYA (RUSSIA)	04-22, 3200m			125.0
URKI KRASNODAR - CENTER (RUSSIA)	09-27, 2500m			122.0
URKK KRASNODAR - PASHKOVSKY (RUSSIA)	05-23, 3100m			128.0
URKN NOVOROSSIYSK (RUSSIA)	04-22, 1780m			123.0
URKW KRYMSK (RUSSIA)	04-22, 2600m			124.0
URMM MINERALNYE VODY (RUSSIA)	12-30, 3900m		12 ILS - 111.7 30 ILS - 109.3	135.0
URMN NALCHIK (RUSSIA)	06-24, 2300m		24 ILS - 110.5	136.0
URMO BESLAN (RUSSIA)	08-27, 3000m		10 ILS - 110.5	141.0

AIRDROME	RUNWAY	TACAN, CHANNEL	ILS	TOWER COMM
URSS SOCHI - ADLER (RUSSIA)	06-24, 3100m		06 ILS - 111.1	127.0
XRMF MOZDOK (RUSSIA)	08-26, 3100m			137.0

Acronyms

A-A	Air-to-Air
A-G	Air-to-Ground
AAP	Auxiliary Avionics Panel
AAS	Air-to-Air Submenu
ACP	Armament Control Panel
ADF	Automatic Direction Finding
ADI	Attitude Direction Indicator
AGL	Above Ground Level
AGM	Air-to-Ground Missile
AHCP	Armament HUD Control Panel
AIM	Air Intercept Missile
AM	Amplitude Modulation
AMIL	Air Mass Impact Line
AOA	Angle of Attack
APU	Auxiliary Power Unit
AR	Aerial Refueling
ARS	Attitude Reference Symbol
ASL	Azimuth Steering Line
ATC	Air Traffic Control
BATA	Bullets at Target Altitude
BHOT	Black Hot
BIT	Built-In Test
CADC	Central Air Data Computer
CATM	Captive Air Training Missile
CBU	Cluster Bomb Unit
CCD	Charge-Coupled Device
CCIP	Continuously Computed Impact Point

CCRP Continuously Computed Release Point

CDI Course Deviation Indicator

CDU Control Display Unit

CICU Central Interface Control Unit

CM Combat Mix

CMS Countermeasure Set

CMSC Countermeasure Set Control

CMSP Countermeasure Set Panel

CR Coordinate Ranging

CR Consent to Release

DLZ Dynamic Launch Zone

DMS Data Management Switch

DP Display Page

DRA Dual Rail Adapter

DRC Desired Release Cue

DSMS Digital Stores Management System

DTOT Desired Time on Target

DTS Data Transfer System

DTSAS Digital Terrain System Application Software

DTTG Desired Time to Go

EAC Enhanced Attitude Control

ECM Electronic Countermeasures

EFC Emergency Flight Control

EGI Embedded GPS INS

EGT Exhaust Gas Temperature

EHE Expected Horizontal Error

EMI Engine Monitoring Instruments

EO	Electro Optical
ET	Elapsed Time
EVE	Expected Vertical Error
FA	Fault Acknowledge
FEDS	Firing Evaluation Display System
FLIR	Forward Looking Infrared
FM	Frequency Modulation
FOM	Figure of Merit
FOV	Field of View
GBL	Gun Bore Line
GBU	Guided Bomb Unit
GCAS	Ground Collision Avoidance System
GMT	Greenwich Mean Time
GPS	Global Positioning System
GS	Ground Speed
HARS	Heading Attitude Reference System
HEI	High Explosive, Incendiary
HOF	Height of Function
HOTAS	Hands-On Throttle and Stick
HPU	Horizontal Position Uncertainty
HSI	Horizontal Situation Indicator
HUD	Heads-Up Display
IAM	Inertially Aided Munition
IAS	Indicated Airspeed
IFF	Identify Friend or Foe

IFFCC Integrated Flight and Fire Control Computer

ILS Instrumented Landing System

INS Inertial Navigation System

ITT Interstage Turbine Temperature

JDAM Joint Directed Attack Munition

JTAC Joint Terminal Attack Controller

JTRS Joint Tactical Radio System

KIAS Knots Indicated Airspeed

LAAP Low Altitude Autopilot

LAR Look Aside Ranging

LASTE Low Altitude Safety and Targeting Enhancement

LOS Line of Sight

LRU Line Replaceable Unit

MAP Missed Approach Point

MFCD Multifunction Color Display

MGRS Military Grid Reference System

MMCB Master Mode Control Button

MRC Minimum Range Cue

MRFCS Manual Reversion Flight Control System

MRGS Multiple Reference Gunsight

MRS Minimum Range Staple

MSL Mean Sea Level

MWS Missile Warning System

NMSP Navigation Mode Select Panel

NWS	Nosewheel Steering
NVIS	Night Vision Imaging System
ORP	Optimal Release Point
OSB	Option Select Button
OWC	Obstacle Warning Cue
PAC	Precision Attitude Control
PBIL	Projected Bomb Impact Line
PBRL	Projected Bomb Release Line
PR	Passive Ranging
PRF	Pulse Repetition Frequency
RGS	Required Ground Speed
RIAS	Required Indicated Airspeed
RTAS	Required True Airspeed
RWR	Radar Warning Receiver
SA	Situational Awareness
SAI	Standby Attitude Indicator
SAS	Stability Augmentation System
SER	Single Ejector Rack
SOI	Sensor of Interest
SPI	Sensor Point of Interest
SPJ	Self-Protection Jammer
SRU	Shop Replaceable Unit
TAD	Tactical Awareness Display

TAS	True Airspeed
TDC	Target Designation Cursor
TER	Triple Ejector Rack
TGP	Targeting Pod
TISL	Target Identification Set Laser
TMS	Target Management Switch
TOF	Time of Fall / Time of Flight
TOT	Time on Target
TP	Target Practice
TTG	Time to Go
TTRN	Time to Release Numeric
TVV	Total Velocity Vector
UFC	Up Front Controller
UHF	Ultra-High Frequency
VHF	Very High Frequency
VPU	Vertical Position Uncertainty
VVI	Vertical Velocity Indicator
WCMD	Wind Corrected Munitions Dispenser
WCN	Warning, Caution, and Notes

CREDITS

Eagle Dynamics Team

Management

Nick Grey	Project Director, Director of The Fighter Collection
Igor Tishin	Project Development Manager, Director of Eagle Dynamics, Russia
Andrey Chizh	Assistant Development & QA Manager, technical documentation
Alexander Babichev	Project manager
Matt "Wags" Wagner	Producer, game and technical documentation, game design
Jim "JimMack" MacKonochie	Producer
Eugene "EvilBivol-1" Bivol	Associate Producer

Programmers

Dmitry Baikov	System, multiplayer, sound engine
Ilya Belov	GUI, map, input
Nikolay Brezin	Smoke effect, new model format support
Maxim Zelensky	AC, AI AC, flight dynamics, damage model
Andrey Kovalenko	AI AC, weapons
Ilya "Dmut" Levoshevich	AI vehicles, ships, triggers
Alexander Oikin	Avionics, aircraft systems
Evgeny Pod'yachev	Plugins, build system
Alexey Smirnov	Effects, graphics
Timur Ivanov	Effects, graphics

Konstantin Stepanovich	AI AC, radio, mission editor
Oleg "Olgerd" Tischenko	Avionics
Vladimir Feofanov	AI AC flight dynamics
Konstantin Tarakanov	GUI, mission editor
Sergey "Klen" Chernov	Weapons, Sensors
Alexey "Fisben" Shukailo	Avionics
Gregory Yakushev	Graphic engine, system
Kirill Kosarev	AI ground units, installer, mission generator
Alexander "SFINX" Kurbatov	AI vehicles, ships
Vitaliy Perepelkin	Avionics
Michael Andreev	Avionics
Eugene Gribovich	Avionics
Dmitri Robustov	Terrain
Denis Tatarnicev	Terrain
Alexey Petrushik	Terrain
Dmitri Kaplin	Terrain
Oleg "Legus" Pryad'ko	Weapons
Sergey "Lemon Lime" Chernov	Dynamic atmosphere

Artists and Sound

Yury "SuperVasya" Bratukhin	AC, vehicles, weapons models
Alexander "Skylark" Drannikov	GUI graphic, AC models
Vlad "Stavr" Kuprin	A-10C cockpit
Stanislav "Acgaen" Kolesnikov	Cockpit, AC, weapons models
Timur Tsigankov	AC, vehicles, ships, weapons models
Eugeny "GK" Khizhnyak	AC, vehicles
Pavel Sidorov	AC models
Constantine Kuznetsov	Sound engineer
Kirill Grushevich	Buildings, Terrain

Sergey "tama" Ashuiko	Buildings, Terrain
Konstantin Miranovich	Buildings, Terrain
Max Lopatkin	Buildings, Terrain
Olga Starovoytova	Buildings, Terrain
Pavel Jankowski	Buildings
Andrey "LISA" Reshetko	Characters

Quality Assurance

Yury "Ulrich" Tkachev	Testing
Valery "USSR_Rik" Khomenok	Testing
Ivan "Frogfoot" Makarov	Testing
Андрей "Андрей Андреевич" Крюченко	Localization

Science Support

Dmitry "Yo-Yo" Moskalenko	Mathematical models of dynamics, systems, ballistics
Alexander "PilotMi8" Podvoisky	Mission Editor Documentation

IT and Customer Support

Alexander "Tez" Sobol	Customer support, WEB, forum
Konstantin "Const" Borovik	System and network administrator, WEB, forum

Campaigns

Matt "Wags" Wagner, "Georgian Hammer" Campaign

Marc "MBoT" Marbot, "The Shore" and "Devil's Cross" Campaigns

Missions

Matt "Wags" Wagner:

Instant actions, Battle Commander, CSAR, Defend Camp Yankee, Free Flight - Black Sea - Air Start, Free Flight - Black Sea - Ramp Start, Free Flight - Black Sea - Runway Start, Sitting Ducks, Khashuri Gap, Overwatch, River Raider, Shooting Gallery, In the Weeds - Coop 4.

Mikita "LOckAndLOad" Machatov:

Hideout, Midnight Train to Georgia, Sunset Sierra.

Stephen "Nate--IRL--" Barrett:

Serpents Head, Serpents Tail.

Frank "Feuerfalke" Bender:

Weapons Training.

Training

Eugene "EvilBivol-1" Bivol

Subject Matter Experts (SME)

A-10 Pilots

David "Leather" Draper

Kevin "Stubby" Campbell

Tom Harritt

Andy Bush

JTACs

Brian "Paco" Filler
Eric Johnson
Greg "Corky" Brown
Tom Nelson

Third Parties

Cato "Glowing Amraam" Bye, Movie Support
Greg Pugliese, Flight Manual proofreading
Zachary Sesar, Nevada Map
Jacob English, Nevada Map
Valery "Valery" Myagky, A-10C skins
Anton "Flanker" Golubenko, A-10C, C-130 skins
Erich "ViperVJG73" Schwarz, A-10C skins
Felipe Ivan "ESA_Lipe" Lorenzo Lopez, A-10C skins
Polina Moskalenko, sounds production

Voiceover Actors

TallCat Studios, Phoenix, AZ (AI Flights, AWACS, Tanker, and ATC)
Shane Stevens (Player) <http://www.imdb.com/name/nm0828772/>
William E. "Hammer" Crudup III (Training Instructor)
Matt Wagner (JTAC)

Tester Staff

Gavin "159th_Viper" Torr
Nikolay "Agn" Borisov
Tikhomir "AirTito" Ivanov
Darrell "AlphaOneSix" Swoap
Enrique "Reisen" González Sánchez
Guillaume "Berkout" Ring
Dmitry "Condor11" Stepanchuk
Pascal "Cougar" Bidegare
Carlos "Design" Pastor Mendez
Guillaume "Dimebug" Leleve
Roman "Dr.lex" Podvoisky
Valery "FV=BlackDragon" Manasyan

James "Eddie" Knight
Kiko "Mistral" Becerra
Daniel "EtherealN" Agorander
Vladimir "Foxbat" Anguladze
Frank "Feuerfalke" Bender
Semen "=FV=MAD" Zimin
George "GGTharos" Lianeris
Matthias "Groove" Techmanski
Igor "=MAF=Mongoose" Chkorov
Dmitry "Laivynas" Koseliov
Zachary "Luckybob9" Sesar
Ed "Manawar" Green
Gennadij "Marks" Tagiltcev
Marc "MBot" Marbot
Michael "MoGas" Stobbe
Stephen "Nate--IRL--" Barrett
Craig "Nemises" Reynolds
Jon Espen "Panzertard" Carlsen
Andrius "Peyoteros" Vaitkevicius
Paul "PoleCat" Johnston
Roberto "Radar Rider" Benedí García
Maksim "RIMM" Boytsov
Rick "rjetster" Ladomade
Bart "Ross" Rosselle
Mark "Shepski" Shepheard
Steve Davies
Roberto "Vibora" Seoane Penas
Erich "ViperVJG73" Schwarz
Peter "Weta43" McAllister
Jacob "Zimster" English

Paul "paulrkii" Kempton
Nick "BlueRidgeDX" Landolfi
Chris "Ells228" Ellis
Evan "Headspace" Hanau
Mick '74th_Tyger' Isted MBE
Timothy "WarriorX" Westmore
Shawn "StrongHarm" Burton
Sheldon "Flim" Cannon
Jesus "mvgas" Gastonrivera
Alexander "BillyCrusher" Bilievsky
Vladimir "Lester" Ivanov

Special thanks to all the Open Beta testers.