



DCS P-47D-30 Thunderbolt

Flight manual

DCS: P-47D-30 for DCS World

Dear User, Thank you for your purchase of DCS: P-47D Thunderbolt!

DCS: P-47D Thunderbolt – it's a simulation of the legendary American WWII fighter and is a sequel to the DCS WWII series, a computer game, combat simulation.

Like previous DCS titles, DCS: P-47D features a painstakingly reproduced model of the aircraft, including the external model and cockpit, as well as all of the mechanical systems and aerodynamic properties. At the same time, DCS: P-47D offers an entirely new experience in the DCS world by placing you behind the controls of a powerful, propeller-driven, piston engine combat aircraft. Designed long before "fly-by-wire" technology was available to assist the pilot in flight control or smart bombs and beyond visual range missiles were developed to engage targets with precision from afar, the Thunderbolt is a personal and exhilarating challenge to master.

The contents of this manual are based largely on actual vintage P-47D manuals of the aircraft's service era.

With homage to the brave pilots of World War II, we hope you enjoy taking this true Flying Legend to the skies and into the fight!

Sincerely,

The DCS: P-47D Thunderbolt Development Team

DCS: www.digitalcombatsimulator.com

Forum: <http://forums.eagle.ru>

© 2012-2020 The Fighter Collection

© 2012-2020 Eagle Dynamics

TABLE OF CONTENTS

INTRODUCTION	X
AIRCRAFT OVERVIEW	12
GENERAL DESCRIPTION.....	12
MAJOR ASSEMBLY PARTS	13
SPECIFICATIONS	17
FUSELAGE	18
CANOPY.....	18
AIRCRAFT COCKPIT	20
WING	21
CONTROL SURFACES	22
AILERONS	23
LANDING FLAPS	24
COMPRESSIBILITY RECOVERY FLAPS.....	25
EMPENNAGE.....	26
RUDDER	27
ELEVATORS	29
LANDING GEAR	30
POWER PLANT	32
TURBOSUPERCHARGER.....	33
WATER INJECTION SYSTEM	35
PROPELLER.....	36
FUEL SYSTEM	37
HYDRAULIC SYSTEM	39
OIL SYSTEM.....	40

ELECTRICAL SYSTEM.....	41
OXYGEN SYSTEM	42
RADIO COMMUNICATION EQUIPMENT	43
ARMOR.....	45
WEAPONS	46
COCKPIT	48
PORT SIDE	49
• Carburetor air lever.....	50
• Air filter control lever	50
• Gun safety switch	50
• Intercooler and oil cooler shutters position indicators	51
• Landing gear control	52
• Landing flaps control.....	53
• Trim tabs control unit.....	54
• Propeller switch box.....	55
• Compressibility recovery flaps control.....	56
• Main switch panel	57
• Fuel selector valve	58
• External fuel tanks selector valve	59
• Canopy switch, intercooler and oil cooler shutters switches	60
INSTRUMENT PANEL	61
• Clock.....	63
• Landing gear warning lights.....	64
• Directional Gyro	65
• Bank and Turn Indicator.....	66
• Rate of Climb Indicator	67
• Compass	68
• Manifold pressure gauge	69
• Artificial Horizon	70
• Tachometer	71
• Carburetor Air Temperature Gauge	72
• Turbosupercharger tachometer and turbo overspeed warning light.....	73
• Engine Gauge Unit.....	74

• Ammeter	75
• Airspeed Indicator	76
• Altimeter	77
• Accelerometer	78
• Suction Gauge	79
• Water Pressure Gauge.....	80
• Fuel Quantity Gauge.....	81
• Hydraulic Pressure Gauge	83
• Oxygen Pressure Gauge.....	84
• Cylinder Head Temperature Gauge.....	85
• Primer	86
• Cowl flaps control.....	87
• Battery control switch.....	88
• Starter Switch	89
• Ignition Switch	90
• Parking brake handle.....	91
• Bomb and Tank Release Controls	92
STARBOARD SIDE	93
• Oxygen regulator	94
• Recognition lights panel.....	95
• Tail wheel lock control	96
• SCR-522-A VHF Radio.....	97
• Radio range receiver	99
CONTROL STICK	100
ENGINE CONTROL QUADRANT	101
• Mixture control lever.....	102
• Turbosupercharger control lever	103
• Propeller control lever	103
K-14 GUNSIGHT	104
KNEEBOARD MAP.....	106
FLIGHT CHARACTERISTICS	108
OPERATING LIMITATIONS	108
• Speed limitations.....	108

• Prohibited maneuvers	108
• Instrument markings.....	109
SPECIAL FLIGHT CONDITIONS	114
• External fuel tanks	114
• Low Level Flight.....	114
NORMAL PROCEDURES.....	116
PRE-START	116
ENGINE STARTUP	124
TAXIING	131
PREFLIGHT CHECK	132
TAKEOFF.....	133
• Normal takeoff.....	133
• Hot weather takeoff	138
• Crosswind takeoff	138
• After takeoff	139
CLIMB	140
EXTERNAL FUEL TANKS RELEASE	140
DIVES	142
LANDING.....	143
STOPPING ENGINE	149
EMERGENCY PROCEDURES.....	151
ENGINE EMERGENCIES.....	151
• Engine overheating	151
• Engine failure	151
• Turbo collapse	154
FIRE	154
LANDING EMERGENCIES	154
• Forced Landing Over Doubtful Terrain.....	154
• Belly landing.....	155
• Forced landing at night	155

BRAKE FAILURE.....	155
HYDRAULIC SYSTEM FAILURE.....	156
TIRE FAILURE	157
DITCHING	157
BAILING OUT	157
• Bailout at High Altitude.....	158
• Bailout in a Spin.....	158
• Bailout over Water	158
COMBAT EMPLOYMENT.....	160
GUNS.....	160
• Aiming with the K-14 Gunsight.....	160
• Target patterns. Correct and wrong.....	166
• K-14 preflight check	167
• Firing guns with K-14 gunsight.....	167
BOMBS.....	168
• Releasing bombs.....	168
RADIO COMMUNICATIONS.....	170
• Easy Communication is enabled	170
• Easy Communication is not enabled	171
RADIO COMMUNICATIONS WINDOW.....	171
F1 WINGMAN	172
• F1 Navigation.....	172
• F2 Engage... ..	172
• F3 Engage With... ..	173
• F4 Maneuvers... ..	174
• F5 Rejoin Formation	175
F2 FLIGHT	175
• F1 Navigation.....	175
• F2 Engage... ..	176
• F3 Engage With... ..	176
• F4 Maneuvers... ..	177

• F5 Formation	177
• F6 Rejoin Formation	183
F3 SECOND ELEMENT	184
• F1 Navigation...	184
• F2 Engage...	185
• F3 Engage with.....	185
• F4 Maneuvers.....	185
• F5 Rejoin Formation.....	186
FLIGHT MEMBER RESPONSES.....	186
F4 JTAC	186
• JTAC Engagement Flow	187
F5 ATC.....	190
F7 AWACS.....	192
F8 GROUND CREW	193
SUPPLEMENTS	195
AIRBASE DATA	195
MORSE CODE ALPHABET	195
SOURCES	199
EAGLE DYNAMICS.....	200
• Executive Board.....	200
• Programmers.....	200
• Designers.....	200
• Sound	201
• Quality Control.....	201
• Localization	201
• IT and Customer Support	201
SPONSORS.....	202
• Bronze Sponsors	202
• Silver Sponsors	212
• Gold Sponsors	215
• Platinum Sponsors	216

- Diamond sponsors..... 217

Introduction

P-47 Thunderbolt is a WWII fighter-bomber, developed by two Russian emigrants – Alexandr Seversky and Alexandr Kartvelly from Republic Aviation Corporation in Farmingdale, Long Island, New York and Evansville, Indiana.

The P-47D was one of the best USAF WWII attack planes. Thanks to the radial engine and the protected self-sealed fuel tanks, it is distinguished by its survivability.

For the shape of the fuselage, the plane got its the informal nickname “Jug”. The British thought that the Jug was short for Juggernaut (Juggernaut - adamant force), referring to the large size and weight, high engine power and impressive armament of the aircraft. Another non-official name for the aircraft is T-bolt.

Weapons of the P-47D-30 consists of eight 0.50” Colt Browning M2 guns with 425 rounds per gun. Thunderbolt can carry up to 1135 kg of bombs and do Air-to-Ground tasks. The aircraft also has the ability to carry up to 10 unguided HVAR missiles.



Figure 1. P-47D-30-

AIRCRAFT OVERVIEW



AIRCRAFT OVERVIEW

General description

P-47D is a one seat, low wing metal monoplane, equipped with a Pratt & Whitney R-2800-59W Double Wasp air-cooled radial engine.

The engine rotates a 4-bladed Curtiss Electric propeller. The aircraft is equipped with hydraulically controlled landing gear, tail wheel, brakes and flaps.



Figure 2. P-47D-30-RE on the ramp

Major assembly parts

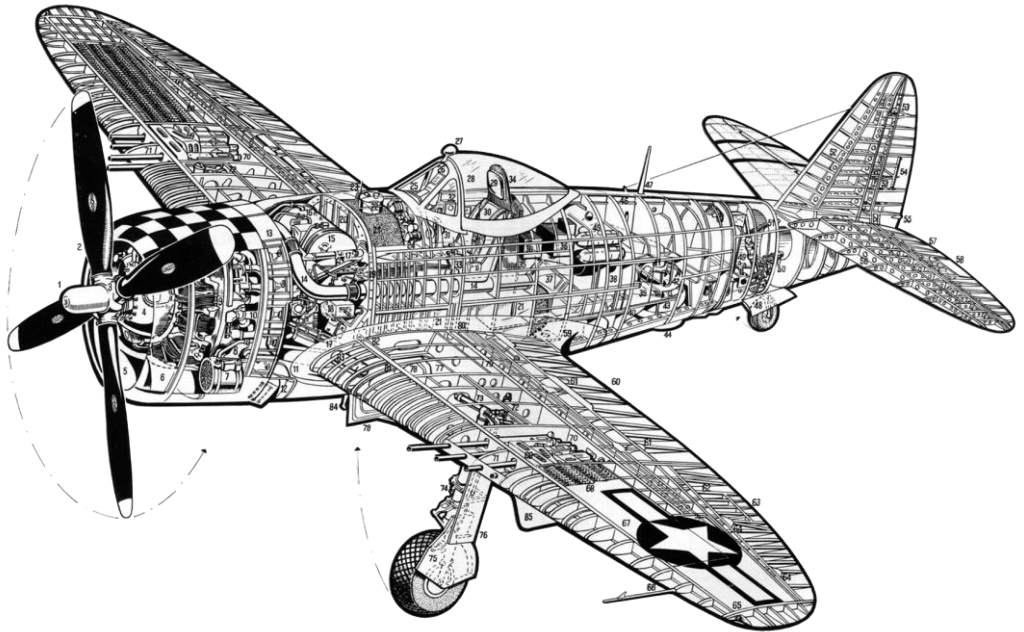

Figure 3. P-47D-30 composition diagram

1. Propeller hub fairing
2. Curtiss Electrics 4-bladed propeller
3. Hub to propeller
4. Reduction gear casing
5. Air duct intake to intercooler
6. Air duct intakes each side to oil coolers
7. Oil cooler (port and starboard)
8. Oil cooler feed pipes
9. 18-cylinder twin-row Pratt & Whitney R-2800-59 air-cooled radial engine

10. Exhaust outlets to collector ring
11. Exhaust gas pipe from collector ring to supercharger
12. Exhaust waste gate
13. Cooling air control flaps
14. Supercharged air-cooling air feed pipe from supercharger to carburetor
15. 30 US gallon water tank for water injection system
16. Feed pipes from oil tank
17. Engine bearer frames
18. Engine accessory units bay
19. Engine control rods and linkages
20. Front bulkhead and firewall
21. Main fuel tank
22. Fuel filler
23. Bead sight
24. Instrument panel
25. Windshield of 12" bullet-resistant glass
26. K-14 Gunsight
27. Rear-view mirror (not installed on P-47D-30RE)
28. Rearward-sliding full-vision bubble canopy
29. Pilot's headrest cushion
30. Pilot's seat and harness
31. Pilot's control column
32. Starboard control and switch panels
33. Engine controls

34. Head armour
35. Back armour
36. Detrola radio.
37. Ducting to intercooler unit
38. Intercooler
39. Intercooler cooling air exit from fuselage sides
40. Exhaust gas feed pipe to supercharger turbine
41. Air filter
42. Turbo-supercharger unit
43. Turbine
44. Flight hood
45. Oxygen bottles
46. Aerial inlet
47. Aerial mast
48. Retractable and steerable tailwheel
49. Tailwheel oleo
50. Tailwheel anti-shimmy damper
51. Tailwheel retraction worm gear
52. Fin construction
53. Hinges to rudder
54. Rudder trim tab
55. Tail light
56. Tailplane construction
57. Statically and dynamically balanced elevators

-
58. Elevator trim tab
 59. Wing root fairing
 60. Landing flaps
 61. Landing flap hinges
 62. Frise type ailerons
 63. Controllable trim tab
 64. Aileron hinges
 65. Port navigation light
 66. Pitot tube
 67. Panel to ammunition bay
 68. 0.50" ammunition (425 rounds per gun)
 69. Feed chutes to machine guns
 70. Gun bay between spars
 71. Gun ports in leading edge
 72. Main undercarriage mounted
 73. Main undercarriage retraction jack
 74. Main undercarriage air-oil shock strut
 75. Fork to wheel
 76. Shock strut cover plate
 77. Wheel well
 78. Wheel cover plate
 79. Rear spar
 80. Rear spar/fuselage attachment
 81. Front spar

- 82. Front spar/fuselage attachment
- 83. Hydraulic fluid reservoir
- 84. Fuel tank or war load shackles
- 85. Underwing pylons

Specifications

Modification	P-47D-30-RE
Wing span, m.	12.42
Length, m.	10.99
Height, m.	4.44
Wing area, m²	27.87
Weight, kg.	
Empty plane	4853
Normal Takeoff	6622
Maximum Takeoff	7938
Engine type	Pratt & Whitney R-2800-59W Double Wasp
Power, h.p.	
Takeoff	1 x 2000
Short-term maximum	1 x 2430
Maximum speed, km. /h.	690
Cruising speed, km. /h.	563
Maximum range, km	
Without external tanks	1529
With external tanks	2898
Maximum climbing speed, m./min.	847
Maximum ceiling, m.	12192
Crew memb.	1
Weapons	Eight 0.50-inch Colt Browning M2 guns. 1135 kg of bombs, napalm tanks or unguided rockets

Fuselage

The fuselage of the P-47 is of semi-monocoque, all-metal, stressed-skin construction, composed of transverse bulkheads and longitudinal stringers. Power kit consists of spars and bends made of aluminum alloy. Front part of the fuselage, including cockpit, consists of 2 halves, upper and lower. Sections are bolted to each other. The rear part of the fuselage is also bolted to the front part. Firewall is made of heat-resistant steel. Engine hood is separated into four removable panels. Air flow that cools the engine is controlled by hydraulically-operated intercooler shutters. There is a main self-sealed fuel tank, located between engine and cockpit. Auxiliary fuel tank is located under the floor of the cockpit.

Armour plates are mounted in front of the instrument panel. There is also one more armour plate behind the pilot. Those plates serve to protect the pilot from gun fire from the front and rear hemispheres. The armor plate withstands conventional rifle caliber bullets.

There is an engine unit compartment, fuel and oil filters in the upper part of the fuselage in front of the canopy of the cabin lantern. Later, an oil tank of 106 liters capacity was installed there. There is a rear fuel tank in the area of the rear spar of the central plank that passes through the fuselage. Radio equipment, oxygen tanks and engine turbo-supercharging system components are located between the cockpit and the rear fuel tank. The turbo-compressor is installed at the bottom of the fuselage closer to the tail. The Intercooler is installed above the turbo-supercharger. Air ducts, that leads engine exhaust fumes to the turbocharger are located on the both sides of the lower part of the fuselage. Air ducts from the turbocharger to the engine carburetor are located on the both sides of the top part of the fuselage. At the bottom of the fuselage is a reinforced welded steel beam which protects the pilot in case of forced landing on the "belly".

Canopy

The P-47D-30 features a teardrop canopy design that allows for an unrestricted view around the aircraft. The canopy slides back and forth and is operated by a switch on the left side of the cockpit. The front part of the canopy consists of armored glass.

Canopy can be jettisoned by a T-handle, which is located above the oxygen regulator.

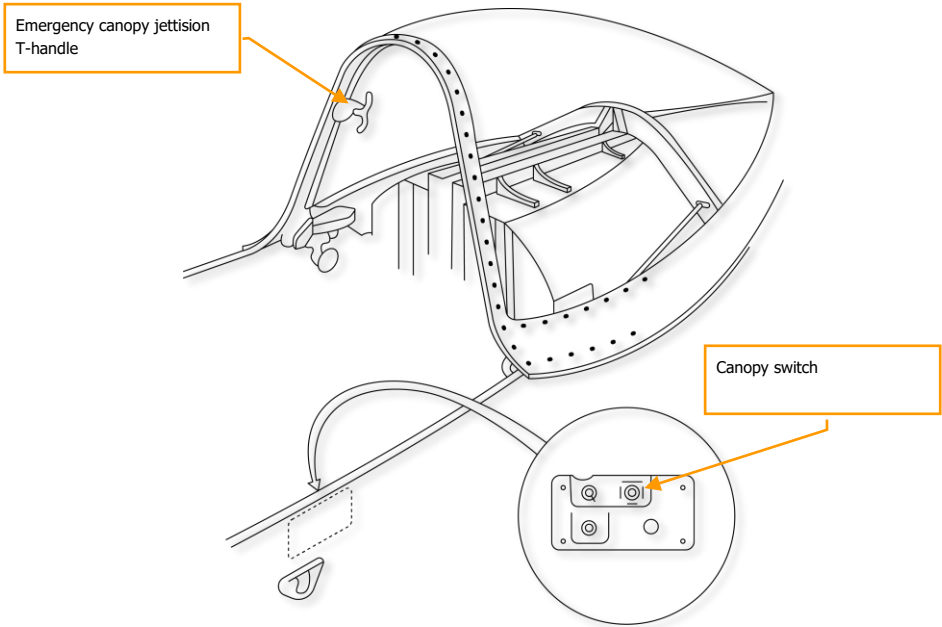

Figure 4. P-47D-30RE Canopy

Aircraft cockpit

The cockpit is not sealed, is equipped with a heating system and a low-profile internal UV light that charges the phosphorescent indicator panels. Pilot's seat with cup under the parachute is adjustable in height. Seat backrest is armored and made of 9.5 mm thick steel that can withstand bullets of rifle caliber. Thick 0.38 mm laminated armored glass is mounted in the cab's drop-shaped lantern. The windshield is heated by hot engine exhaust gases. The sliding canopy segment can be jettisoned if necessary, without opening it.



Figure 5. P-47D-30RE cockpit

Wing

The console wing represents further development result of the Seversky wing. Main parts of the wing are two main spars which support attachment of the wing to the fuselage and three auxiliary spars, one each supporting the aileron and flap and the other supporting the landing gear.

Wing consoles are bolted to the fuselage. Ailerons (Frise type) on the P-47D-30 have metallic cladding. Aileron area equals $3,177 \text{ m}^2$ or 11,4% of the wing area. The area of the hydraulically controlled flap is equal to $3,62 \text{ m}^2$ or 13% of the wing area. The angular deviation of the chord wing from its horizontal reference is +6 degree, setting angle of attack +-1 degree, front edge sweep is equal to +3 degrees. The length of the middle aerodynamic chord is 2,221 m.

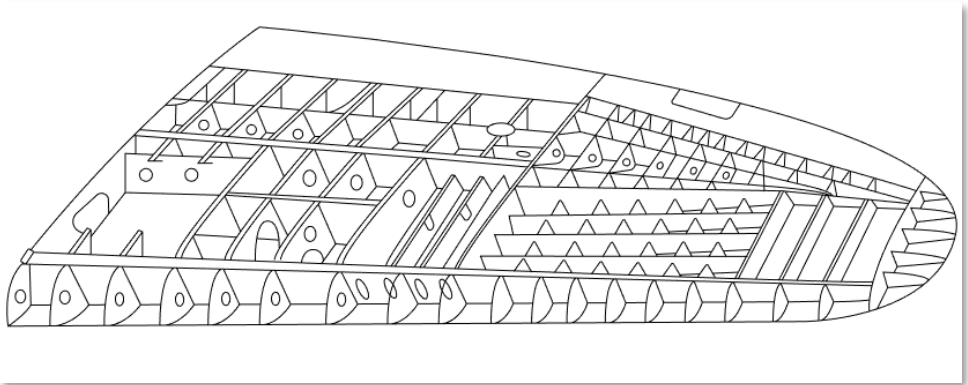

Figure 6. Schematic drawing of the P-47D-30RE wing

The wing console has an ammunition bay. There are removable panels installed above the compartment which are used for accessing the machine guns and changing the cartridge ribbons. Navigation lights are mounted on the wing tips, colored recognition lights are mounted on the lower surface of the right-wing console. Tail fin and stabilator panels have two power spars and ribs each. Steering is a rope control.

Control surfaces

The ailerons, elevators, and rudder are controlled by a conventional stick and rudder pedals. Conventional stick is used to manage aircraft roll and pitch. Pedals control the yaw of the aircraft.

Flaps are hydraulically actuated by a lever located on the left side of the cockpit and flaps can be lowered at any desired angle (up to 40°). It takes 11-15 seconds for the flaps to go from the full up to the full down position.

The “blunt-nose” ailerons are used on aircraft P-47D-30 and up, they reduce the probability of aileron buffing when diving at high speeds.

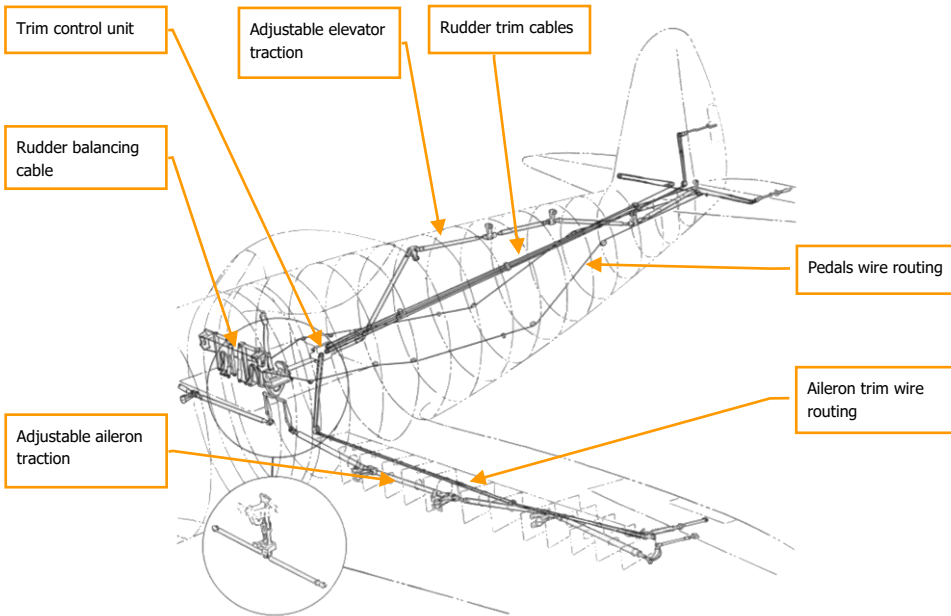

Figure 7. Ropes, cables and rods layout

Control surfaces have the following angular constraints: rudder: $\pm 28^\circ$, elevator: $+30^\circ / -20^\circ$, ailerons: $\pm 13^\circ$.

Trim control unit is located on the left side of the cockpit.

Ailerons

Ailerons of the P-47, representing about 11.4% of the total projected wing area, are Frise type, aerodynamically and dynamically balanced and are 16 in-lb overbalanced. They are hinged to steel forgings attached to the outboard auxiliary wing spar and are controlled by a system of push-pull rods; an all metal controllable trim tab is provided in the left aileron.

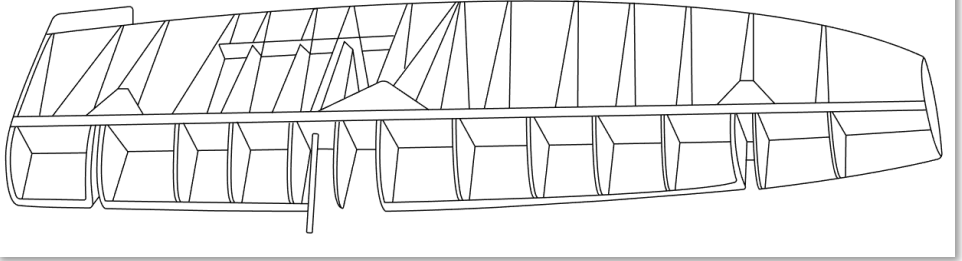

Figure 8. Schematic drawing of P-47D-30RE aileron

Ailerons are controlled by a system of two-pin rods. Flanged nose and tail ribs of 24-ST, are attached in staggered fashion to a main spar and alclad 24-ST sheet is flush riveted to spar and ribs.

Forged aluminum alloy hinges of the aileron are attached to the outboard auxiliary wing spar.

Landing flaps

Landing flaps of the P-47, representing 13% of the total projected wing area, are NACA slotted trailing edge type. Flaps are hydraulically actuated. When retracting, the flaps move up first, then forward. This trajectory, set by the trapezoidal joints, ensures that the flaps are ideally positioned relative to the wing, thus maintaining the proper aerodynamic profile.

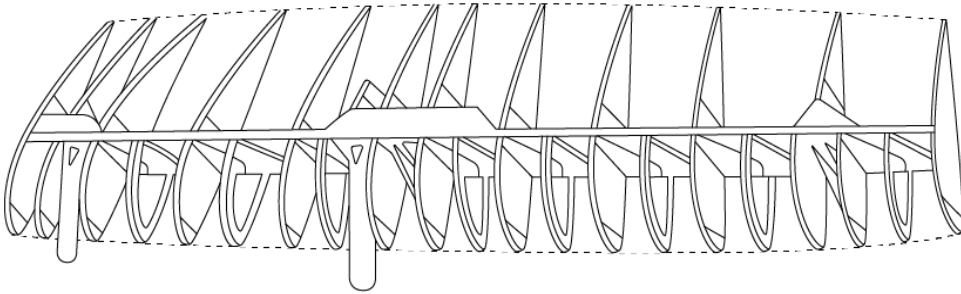

Figure 9. Schematic drawing of the P-47D-30RE landing flap

The flaps are fastened to the joints of the traction system and levers using standard bolts. The double cambered external surface of the flap is clad 24-ST riveted to flanged nose and tail ribs which attach to a spar of 24-ST in symmetrical order; additional lightened reinforcing nose ribs are provided between each pair of the flanged nose ribs.

Compressibility recovery flaps

The design of the aircraft includes special compressibility recovery flaps, which are used to aiding in recovery from dives of compressibility speeds. These surfaces are operated by two electric, reversible, intermittent motors synchronized by flexible shafting. Electromagnetic brakes and couplings are integrated into the flaps control system to prevent overstepping of the limit position.

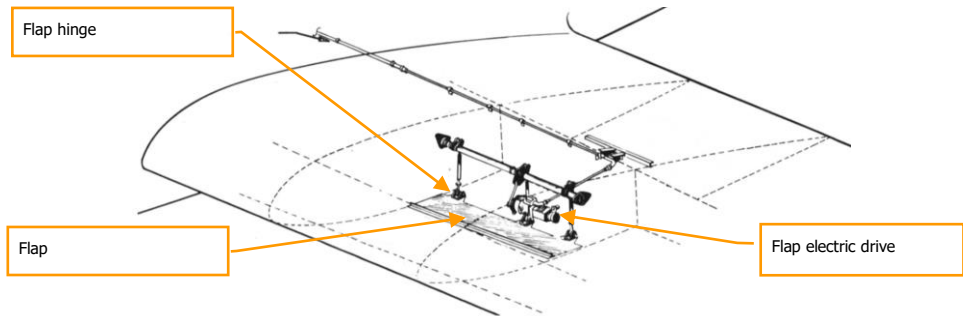

Figure 10. Design of the recovery flap

Deviation angle of the flaps is 21° , which, in turn, ensures that the safe optimum G-force is maintained when pulling from the dive. The compressible recovery flaps are .188" flat sheets of 24-ST and are hinged at the landing gear auxiliary spar, located just forward of the landing flaps.



Figure 11. Left recovery flap

Empennage

The empennage of Thunderbolt is a full cantilever structure with a total projected area of 81.45 sq. ft. All surfaces are metal covered and the elevators and rudder are equipped with controllable trim tabs of all metal construction.

Fin and the horizontal stabilizer assembly of the P-47 are of similar construction, both assemblies employing flanged ribs between a forward and aft spar and flanged nose ribs with 24-ST alclad skin.

Hinges for the tail surfaces and chain-actuated worm and screw units for trim tab operation are attached to the aft spars of both assemblies. To install the complete stabilizer unit to the fuselage, the stabilizer forward spar is bolted to fittings on the horizontal web of the aft fuselage section and the aft spar is bolted to a plate fastened to the last frame of the fuselage.



Figure 12. T-bolt empennage

Rudder

The rudder is Handley-Page type having static and dynamic balance. The rudder trim tab provided dynamic balance as well as selective trim.

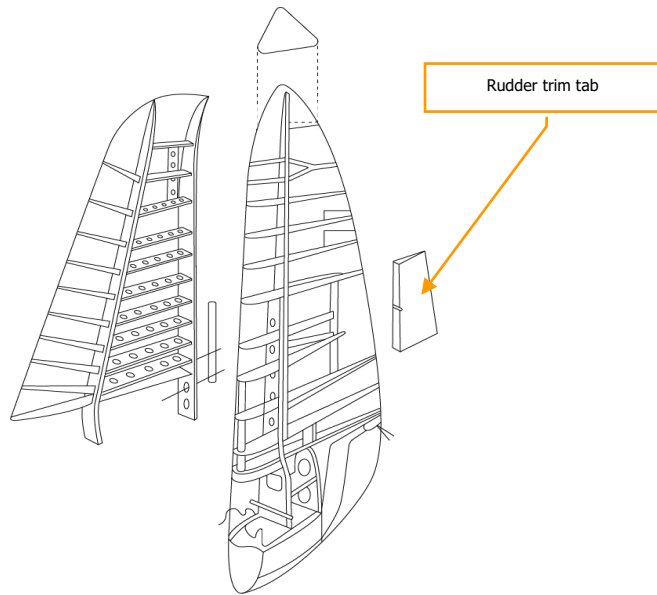

Figure 13. Rudder schematic drawing

Like all other surfaces, the steering wheel is covered with skins of Alclad alloy.

Elevators

The elevators of the Thunderbolt are manufactured singly and are assembled into a unit by splicing torque tubes extending from the inboard nose sections of the elevators. The entire surfaces of the elevators are 24-ST alloy covered and constructed of a spar and stamped, flanged ribs; the torque tubes are secured to the first three inboard nose ribs of each elevator.

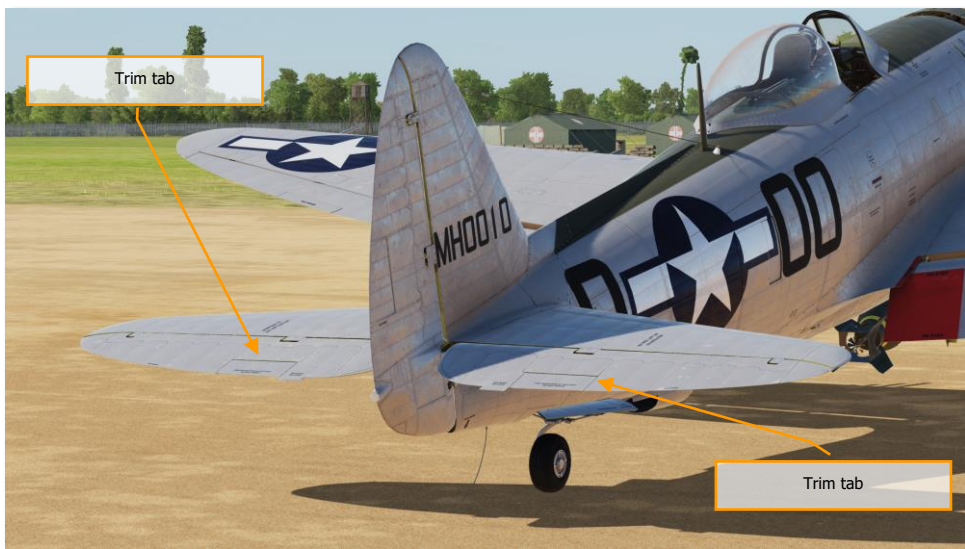

Figure 14. Elevators trim tabs

The elevators are hinged to the rear stabilizer spar and a torque-tube-pivot is provided by roller bearings staked in hinge brackets which are attached to the rear fuselage frame. The last control rod is linked to the elevator at a bracket that is part of the torque tube splice sleeve.

Landing gear

The Thunderbolt has a fully retractable landing gear. Gear retraction is done by means of pressure, which is created inside hydraulic cylinders. Pneumatic wheel size of the main gear – 864x229 mm. Hydraulic brakes on the wheels are controlled by the rudder pedals.



Figure 15. Main landing gear

The tail wheel is a free-wheeling, hydraulically retractable element. The tail wheel can be locked in longitudinal position by means of the control handle with yellow ball, which is located to the right of the pilot's seat.



Figure 16. Hydraulically retractable tailwheel

Power plant

The power plant of the P-47 is a Pratt & Whitney R-2800-59W, air-cooled, radial, twin row, 2000 hp engine with water injection. R-2800 definition means "Radial engine with total capacity of 2800 cubic inches", which is equal to 45,9 liters.

Its length - 72,75", 52,5" in diameter, with weight of 1068 kg. The engine is equipped with a single-speed mechanical compressor. P-47D-30RE modification is equipped with a "Curtiss Electrics" 4-bladed propeller.

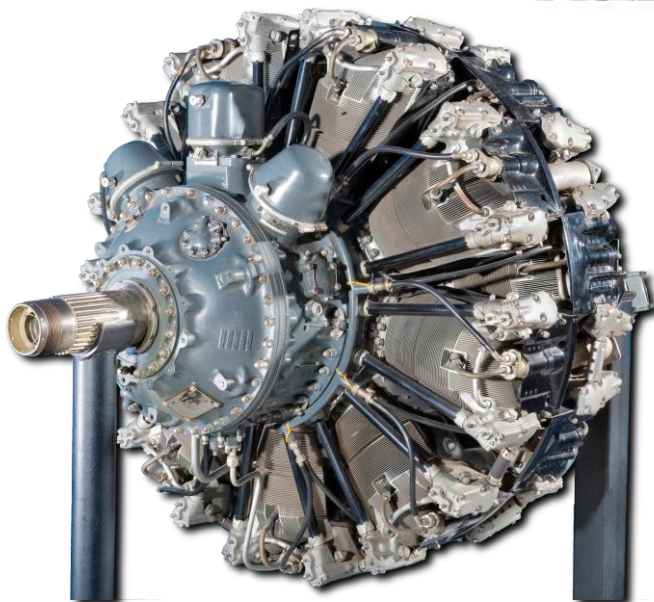

Figure 17. Pratt & Whitney R-2800-59W Power plant

Turbosupercharger

Thanks to a turbosupercharger, the Thunderbolt got his fame as a high-altitude fighter. Turbosupercharger is installed at the rear of the fuselage, which entailed the installation of long pipelines: engine air tunnel, long exhaust pipes and the air tunnel to the intercooler, which is located near turbosupercharger and is used to cool compressed air.

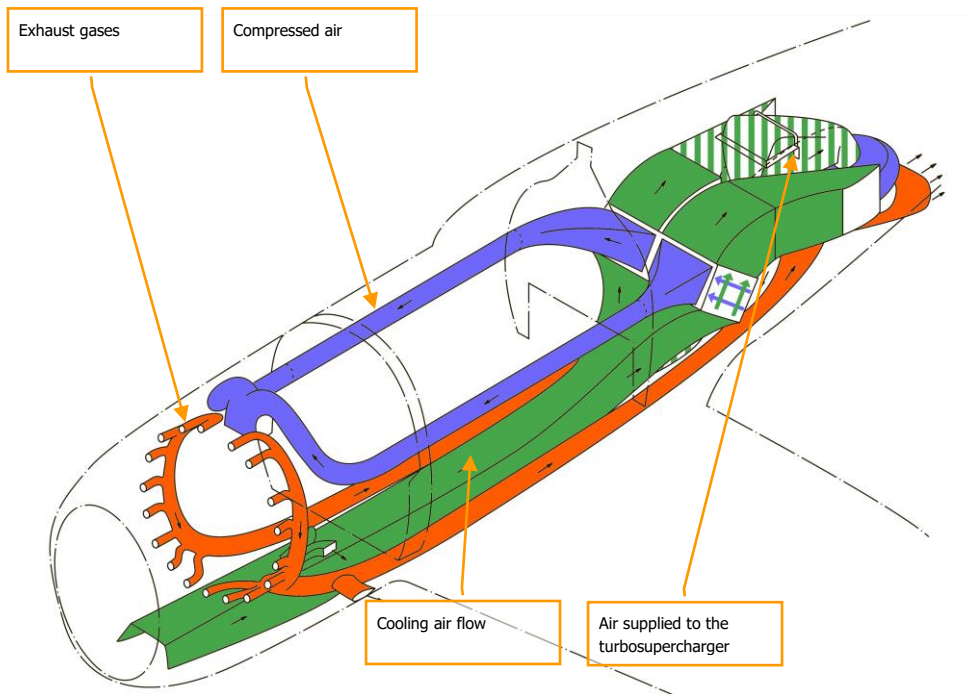

Figure 18. Exhaust system

The principle of operation of the turbocharger is as follows: the exhaust gases coming from the engine are directed to the gas turbine which drives the compressor, which in turn compresses the air. A side effect of such compression is the strong heating of the air. Therefore, the air is cooled down by an intercooler, which is installed in the tail section, before it enters the engine cylinders.

Cold air for blowing the intercooler is drawn from the air intake, which is placed under the engine. Then it passes through a long duct, and is supplied to the outer surfaces of the intercooler tubes to cool the compressed air, coming from the turbocharger to the carburetor, and then, it is released through two adjustable nozzles on the sides of the fuselage tail section.

Part of the hot air is diverted from the turbocharger to the wing console for heating machine guns, which can freeze when flying at high altitudes.

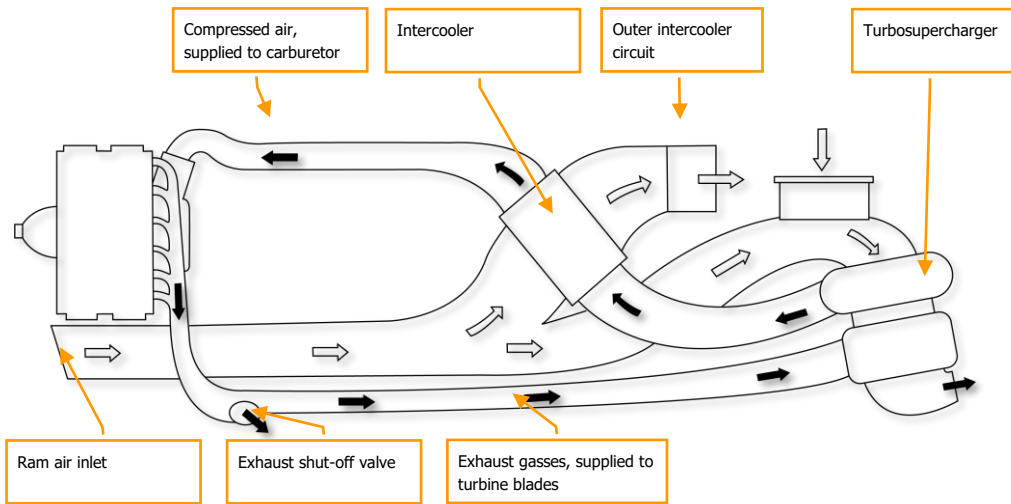

Figure 19. Air traffic pattern

Typically, a turbocharger is used at altitudes more than 12,000 feet, as well as for takeoff and emergency boost at any altitude.

Water injection system

A water injection system (water-methanol mixture) has been installed on the aircraft in order to enable a significant increase in the power of the engine in flight.

The mixture is injected finely into the inlet manifold and then entrained into the cylinders. The presence of the water reduces the temperature of the mixture, which makes it possible to increase the supercharging and increase the efficiency of the engine and get more power without causing detonations.

Water injection system consists of a 30-gallon consumable water tank, an engine driven pump, water pressure regulator, a relief valve and automatic boost-reset.

Water injection is controlled by a switch, which is located on the throttle. The switch opens a solenoid valve that transmits a mixture of water and methanol to the regulator. At the same time, the automatic boost mechanism is triggered under water pressure in the supply line and the mixture is impoverished to reduce fuel consumption. The water injection system is heated in flight by the engine heat, which prevents the system from freezing in flight.

Water injection occurs when the engine is running in War Emergency Power (WEP) mode. The pressure in the collector reaches then up to 64 inches of Hg, increasing power by 30%.

Propeller

The P-47D-30 engine rotates a 4-bladed Curtiss Electrics constant air speed propeller. Propeller pitch is changed electrically. Its diameter is 12 feet and 2 inches, blade pitch range - 33° (from 23° in low and up to 56° while in high pitch mode).



Figure 20. Curtiss Electrics 4-bladed constant speed propeller

The Propeller is controlled by switches, installed on a small box that is located on the left side of the instrument panel, and propeller governor that is located in the Throttle Quadrant. Propeller governor handle can be coupled with a throttle using a special latch.

Fuel system

The P-47D-30 has two self-sealing fuel tanks with a total capacity of 370 US gallons. Main fuel tank capacity is 270 gallons. Auxiliary fuel tank – 100 gallons. Fuel reserve can be increased with 3 external fuel tanks.

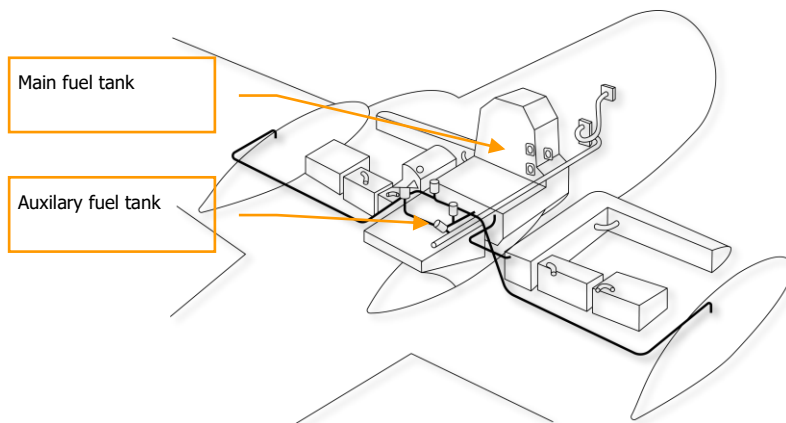

Figure 21. P-47D-30 fuel system

Fuel is fed into the carburetor by a mechanical fuel pump mounted directly on the engine, with variable capacity electric pumps installed in each of the tanks. Fuel pumps are controlled by a rheostat, which is mounted on the main switch panel.

The Thunderbolt can carry three external fuel tanks in order to increase flight range.

When external tanks are used, none should be dropped until all are empty, as the pressurizing system would be inoperative.

External fuel tanks jettison procedure is described in the "Standard procedures" chapter.

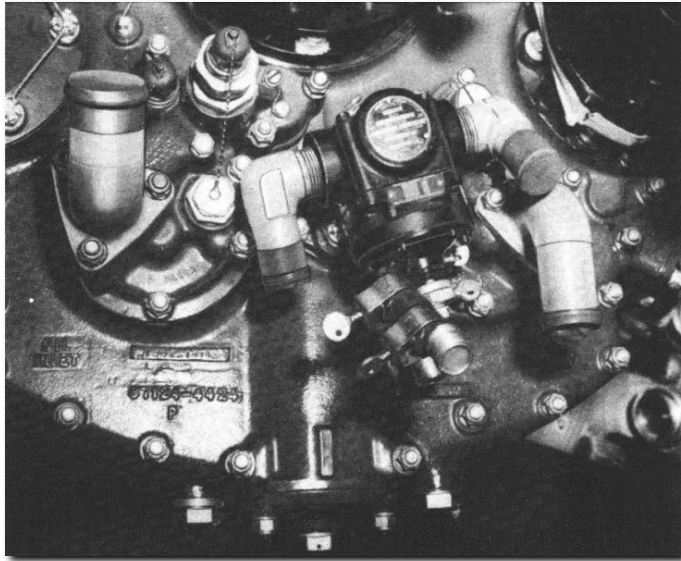

Figure 22. Fuel pump

Hydraulic system

The hydraulic system consists of two routes - working and return. It is designed to control the operation of the landing gears, landing flaps and cowl flaps. The working pressure in the system is created by a hydraulic pump.

The fluid is drawn from the 1.9 US gallon supply tank in the upper section of the engine compartment and pumped into the system through a pressure regulator. This unit admits fluid to the system when the system pressure drops to 800 psi and returns fluid to the supply tank when system pressure reaches 1,000 psi.

A hand pump is installed on the left side of the pilot's seat for use in the event the engine-driven pump fails.

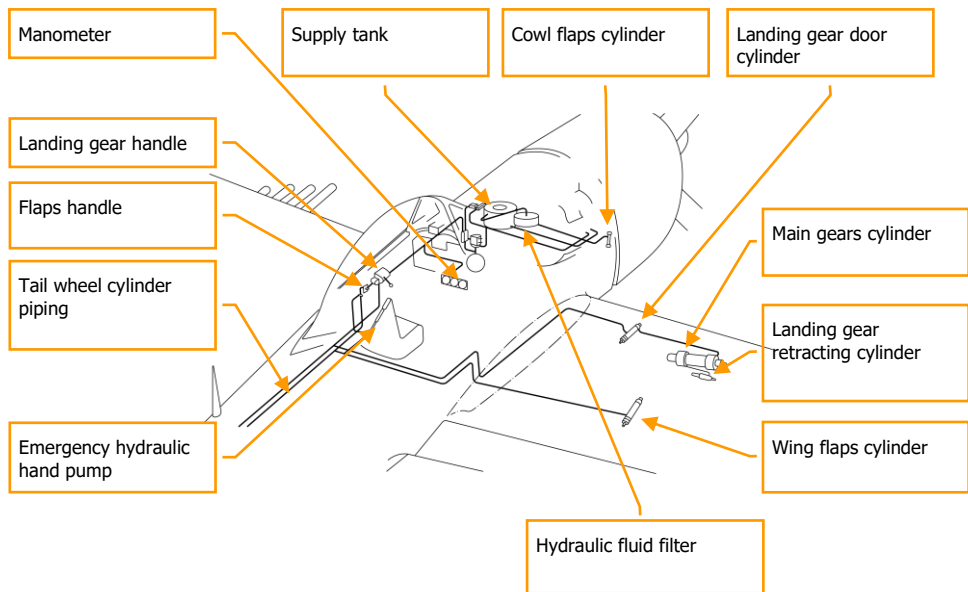

Figure 23. Hydraulic system of the P-47D-30

Oil system

There is an oil tank in the upper part of the engine compartment with a filling neck. The tank has a total capacity of 28 gallons.

There is one oil cooler with shutters at the bottom left and right part of the engine compartment. Oil shutters are electrically controlled by two switches that are located above the throttle quadrant. Oil cooler and intercooler shutters indicators are located on the left side of its respective switches.

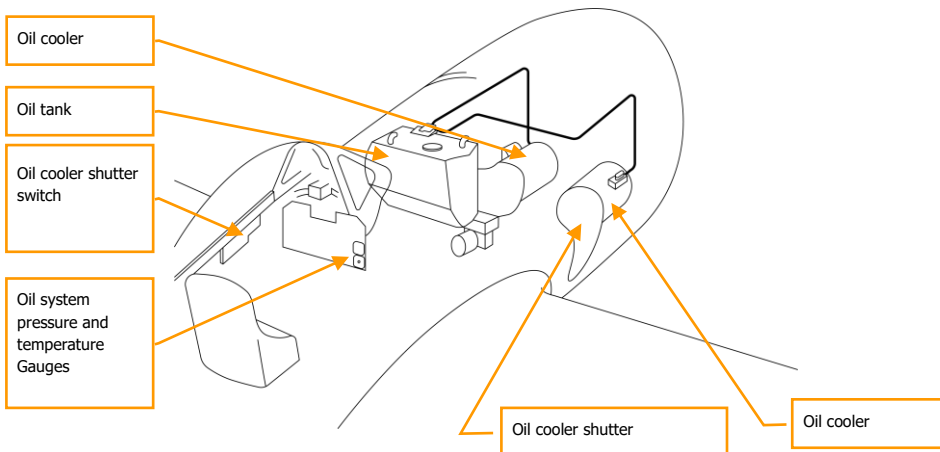

Figure 24. P-47D-30 oil system

Electrical system

The electrical system is a 24-volt DC, single wire grounded type, energized primarily from a 100-amp generator. The ammeter is located on the instruments panel and shows the charging current.

A plug in the right forward engine cowl reached through an access door permits the attachment of an external source of power for flight line service.

A battery is installed on the starboard side of the aircraft.

Oxygen system

Breathing oxygen is supplied from six bottles located in the fuselage aft of the cockpit and in the left-wing leading edge. An oxygen demand regulator is located to the pilot's right on the cockpit wall. A pressure gauge and flow indicator are mounted on a sub-panel to the right of the instrument panel. The cylinders can be charged through the oxygen filler valve located on the fuselage left side aft of the cockpit. Normal pressure in the oxygen system is 400 psi.

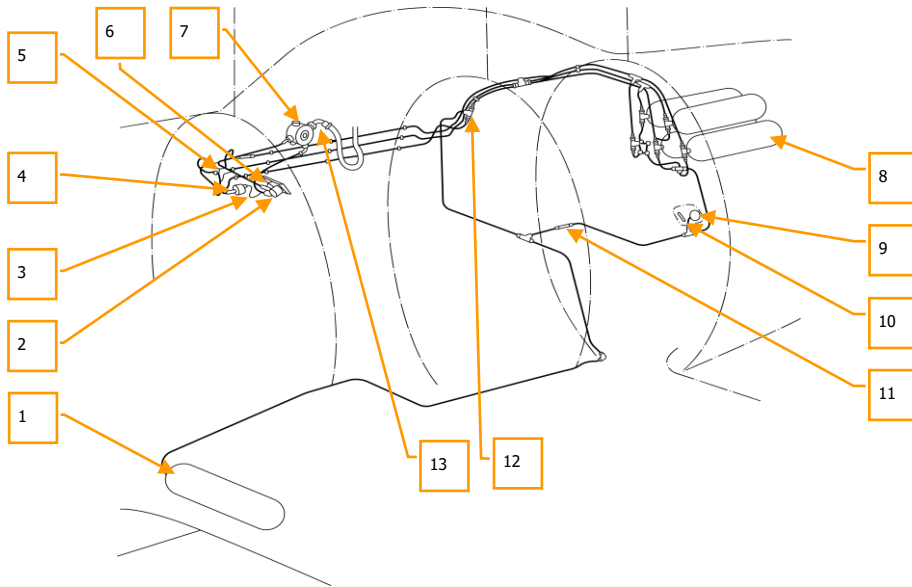

Figure 25. Oxygen system P-47D-30

1. Wing oxygen bottle
2. Oxygen flow indicator
3. Wire to signal lamp
4. Pneumatic pressure sensor signal
5. Three-way valve
6. Oxygen pressure Gauge
7. Oxygen flow regulator
8. Oxygen bottles
9. Filling valve
10. Connecting sleeve
11. Pressure control connection
12. Double-return valve
13. Tube

Radio communication equipment

The radio equipment of the P-47D-30 consists of: a SCR-522 VHF (Very High Frequency) radio for voice communication, a Detrola LF (Low Frequency) radio receiver and an SCR-695A IFF (Identification Friend or Foe) radio.

VHF radio is a voice command station. Like all VHF radios, the range of operation increases with flying altitude.

The radio controls are located on the right side of the cockpit wall.

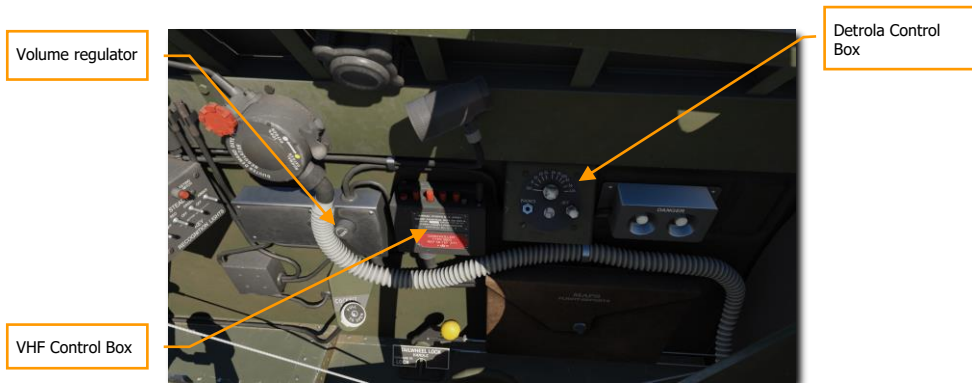

Figure 26. VHF control box

Four channel buttons, marked by letters, are tuned to the required frequency on the ground by the ground personnel (in simulation it is set in the Mission Editor). To use the desired channel, click on the corresponding button. After pressing, the corresponding green lamp is lit. Press OFF button to stop transmission.

Mode switch, located at the bottom of the VHF control box has 3 positions: T (Transmit), R (Receive) and REM (Remote).



Figure 27. VHF control box

The most used position of the mode switch is REM. In this position, all communications are done by using the Push-To-Transmit button located on the throttle.

Reception is automatic. If the microphone button is not pushed, reception is performed with the switch in R or REM position, and transmission is performed with T. Do not leave the switch in the T position, because this will activate a constant transmission, which will cause "contamination" of the radio channel.

The receiving control lamp next to the channel switch lits when the radio station can receive signals and goes out when the pilot performs a transmission.

Armor

Armor plating is provided at two points: back of the pilot's seat and behind the instrument panel, in front of the cooling system tank. In addition, the pilot is additionally protected by a bulletproof windshield and the engine itself, which protects the pilot from the frontal hemisphere fire.

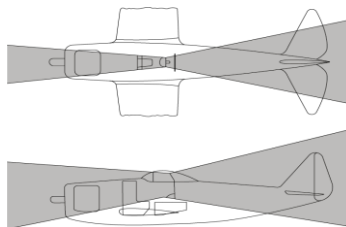
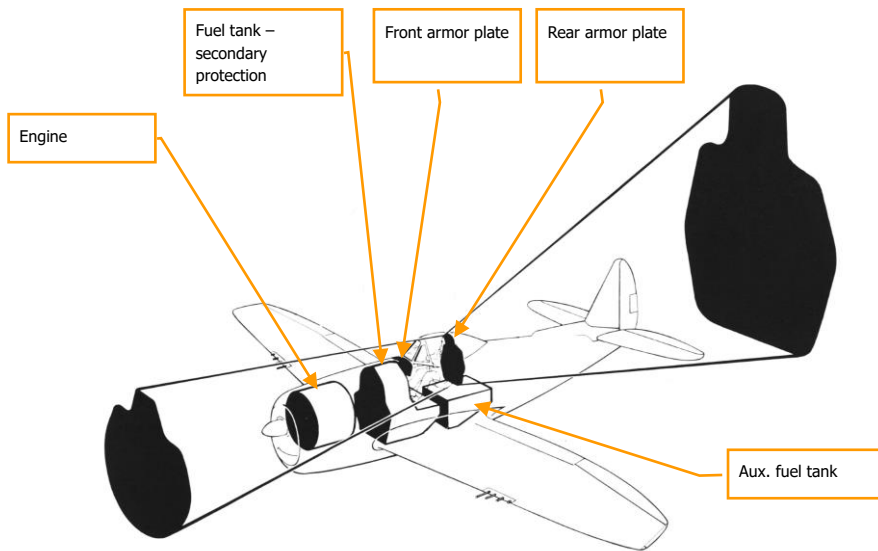

Figure 28. P-47D-30 Armor

Weapons

Armament of the Thunderbolt includes eight Colt Browning M-2 (0.50-inch caliber) machine guns, installed in the wings. Normal ammunition are 425 rounds per gun. Machine gun rate of fire is 800-890 shots per minute. Machine gun barrels overheat when firing long salvos (recommended firing time are 3 seconds).

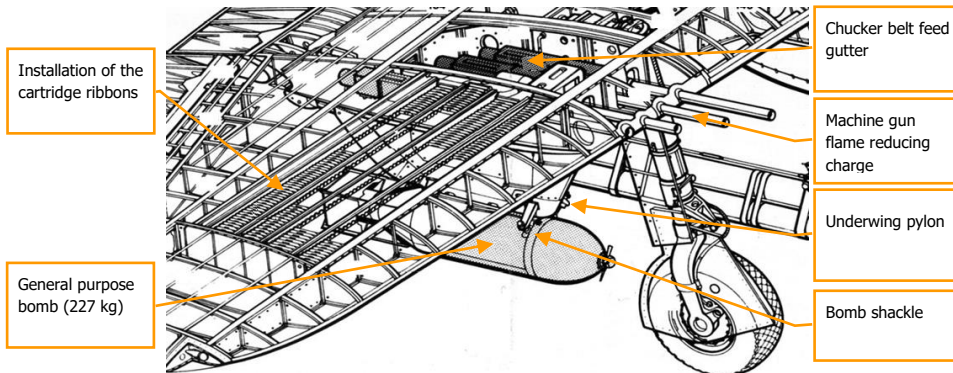

Figure 29. Placement scheme of the machine guns in the wing

Another type of the armament that the Jug can carry are unguided 4.5-inch M-8 rockets with folding tail fins. Rockets are launched from M-10 tubular launchers, which are made of magnesium or steel alloys.

You can also load unguided 5-inch HVAR missiles, various bombs and napalm tanks and lacrimogeneous gas or smoke containers. Napalm tanks are made of refined external fuel tanks.

Note! Currently, napalm and chemical weapons are not implemented in DCS World.

COCKPIT

FLAP WARNING

DO NOT LOWER FLAPS ABOVE 155 MPH
BEST SETTING FOR TAKE OFF WITH
HEAVY LOAD OR SHORT FIELD
16 TO 20 DEGREES

THIS AIRPLANE EQUIPPED WITH
JETTISON CANOPY
RECOMMEND CANOPY BE OPEN ON
TAKEOFF AND LANDING

SERVICE THE AIRPLANE
WITH 100 OCTANE FUEL
ONLY IF NOT AVAILABLE
THE NEXT HIGHER GRADE
WILL BE USED IN EMERGENCY



DO NOT
FLAPS
I.A.S



WARNING UP TO 30 GAL. OF RETURNING
FUEL THROUGH CANNISTER FOR 10 SECONDS
FUEL FLOW INDICATOR BLINK OFF MAIN FUEL
PANEL

OXYGEN

BLINKER
OXYGEN FLOW INDICATOR

COCKPIT

This section will familiarize you with the Thunderbolt's cockpit. You should understand the purpose and location of all controls and instruments in the cockpit for confident piloting.

The P-47D-30 cockpit can be separated into 6 main parts:

- port side with main switch panel, trim tabs unit, flaps and gears control handles, oil and intercooler shutter controls and indicators, dive flaps control, etc.;
- engine control quadrant, which consists of: throttle, propeller governor, supercharger control handle and mixture control handle;
- instrument panel, on which you can find different Gauges, battery/ignition/starter switch and propeller switch box;
- K-14 gunsight;
- Control stick;
- Starboard side with communication and oxygen equipment.

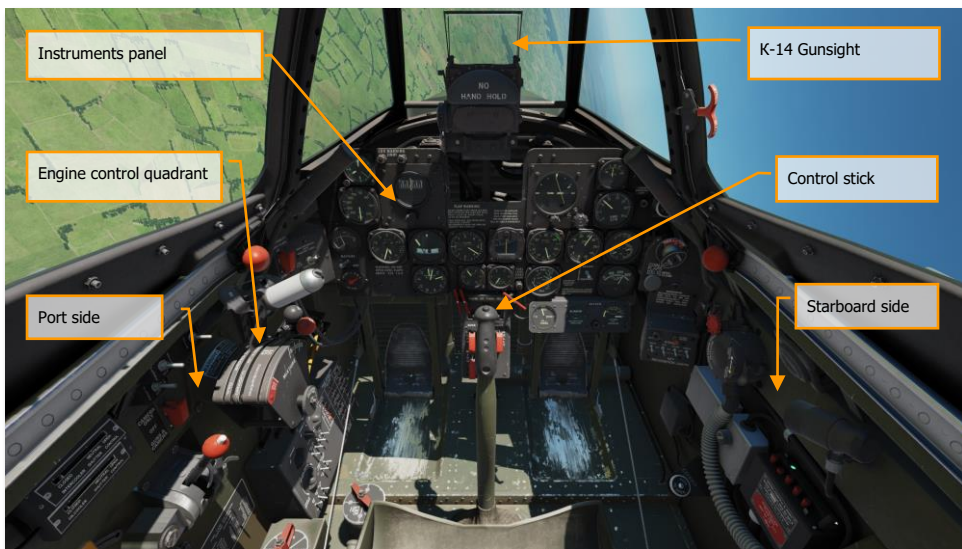

Figure 30. P-47D-30 Cockpit

Port side

Port side of the Thunderbolt's cockpit consists of:

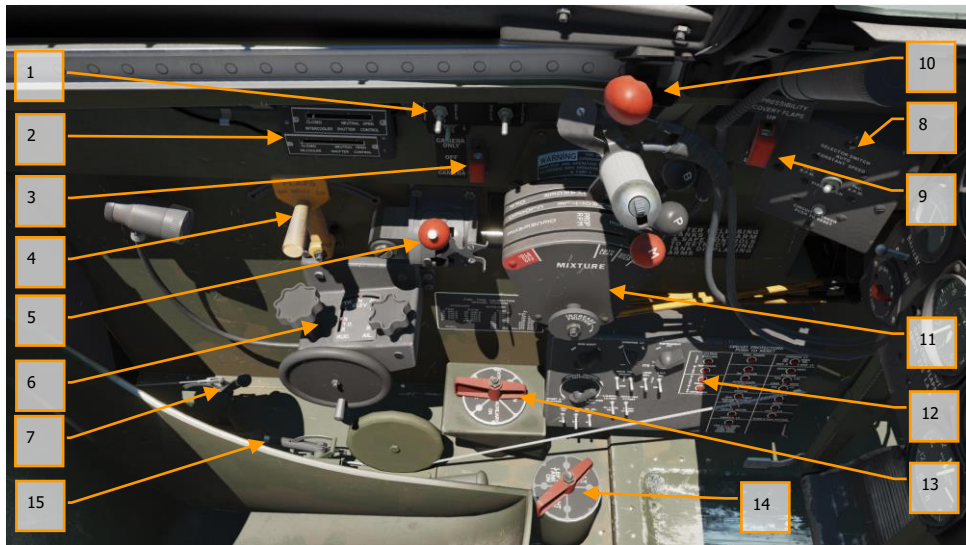

Figure 31. Port side

1. Canopy switch, intercooler shutters and oil cooler shutters controls.
2. Intercooler and oil cooler shutters position indicators.
3. Gun safety switch.
4. Landing flaps control.
5. Landing gears control.
6. Trim tabs unit.
7. Carburetor air lever.
8. Small propeller control box.
9. Dive flaps switch.
10. Canopy control.
11. Throttle quadrant.
12. Main switch panel.
13. Fuel selector valve.
14. External tanks selector valve.
15. Air filter control lever.

Carburetor air lever

This lever is used to provide additional hot air to the carburetor in cold weather or icing conditions and is set in COLD position by default.

- **COLD.** Cold air supply to the carburetor.
- **HOT.** Hot air supply to the carburetor.

Air filter control lever

The lever controls the air supply to the cabin through a dust filter and is used in dusty conditions. The lever has 2 positions:

- **ON.** The supplied air to the cabin will pass through a special air filter.
- **OFF.** The air, which is supplied to the cabin will be bypassing the air filter.

Gun safety switch

This switch controls the gun camera, machine guns and applies power to the K-14 gunsight.

Gun camera is mounted in the leading edge of the wing and is working in combination with machine guns. The gun camera can also operate independently of the machine guns.

Gun safety switch has 3 positions:

- CAMERA ONLY (power is applied only to camera and gunsight)
- OFF – powers off weapons, camera and gunsight
- GUNS & CAMERA (applies power to guns, camera and gunsight)

Power to the machine gun trigger solenoids is blocked for safety reasons at the parking by the landing gear handle and can only be applied when handle is in the upper position when the gears are UP and locked.

Note. Gun camera is not implemented in DCS P-47D-30.

Intercooler and oil cooler shutters position indicators

Indicators show the position of the intercooler shutters (panel doors on each side of the fuselage) and oil cooler shutters and are located on the left side of the cockpit. Indicators have 3 marks: CLOSED, NEUTRAL and OPEN. The shutters actuators are controlled by the switches installed next to the indicators (not shown on the picture under).

During takeoff intercooler and oil cooler shutters are set to neutral position. In flight, these are managed to control oil and carburetor air temperature as indicated on the main instrument panel.

Standard flight is performed with intercooler shutters set to OPEN. But in cold weather, it may be necessary to install the shutters into the intermediate position or even close them to ensure the temperature of the mixture is at 25°C. Normal shutters position at speeds above 350 mph - NEUTRAL.

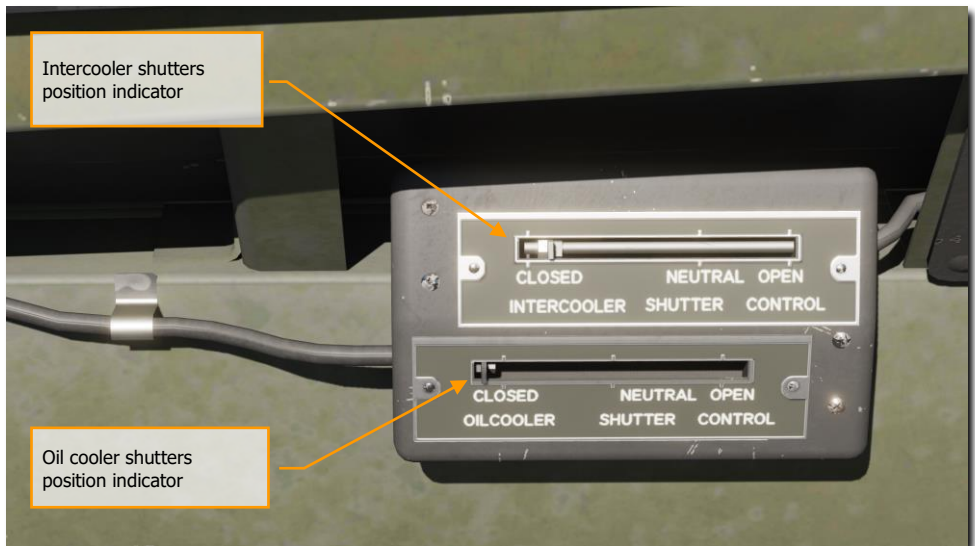

Figure 32. Intercooler and oil cooler shutters position indicators

Landing gear control

The landing gear is raised and lowered using a lever on the left side of the cockpit. With the white button, the lever can be set to the UP or DOWN position. A spring-loaded safety latch on the right side of the handle is used to prevent accidental gears retraction/extension.

When changing the position of this lever, except emergencies, it is very important to wait until the retraction/extending cycle is fully complete.

Neutral lever position is used in case of hydraulic system failure due to fluid loss. After the gears has been fully lowered and locked, it is recommended to lower the landing flaps.

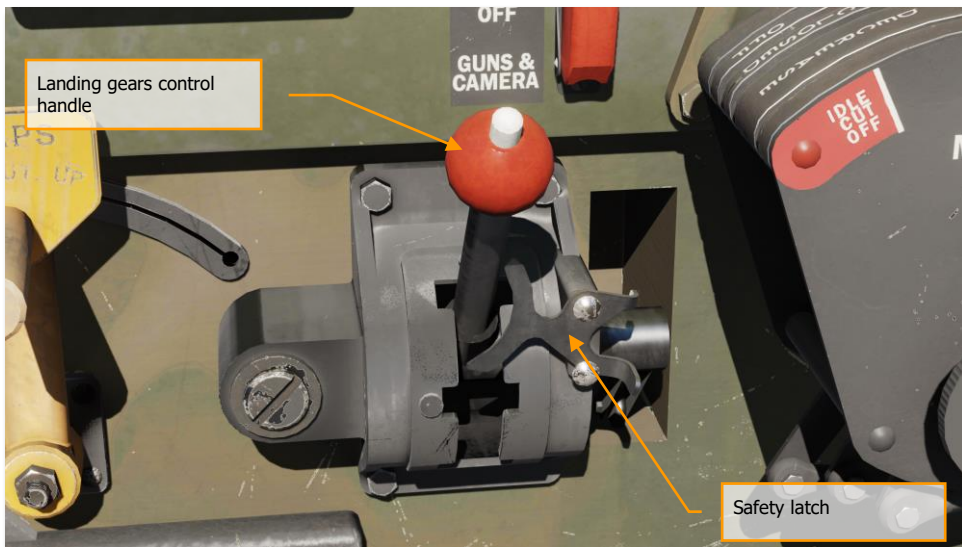

Figure 33. Landing gears control handle

When operating the P-47D, do not set the Landing Gear Control handle to the UP position while the aircraft is on the ground!

Landing flaps control

This lever controls the landing flaps and has 3 positions:

- **UP** – flaps retraction
- **NEUTRAL** – stops retraction/extension
- **DOWN** – flaps extension



Figure 34. Flaps control handle

The maximum angle of the flaps extension is 40°. For a more precise setting of the flap extension angle, the angle marks in the upper left corner of the left flap and in the upper right corner of the right flap are used. These markers are visible from the cockpit.

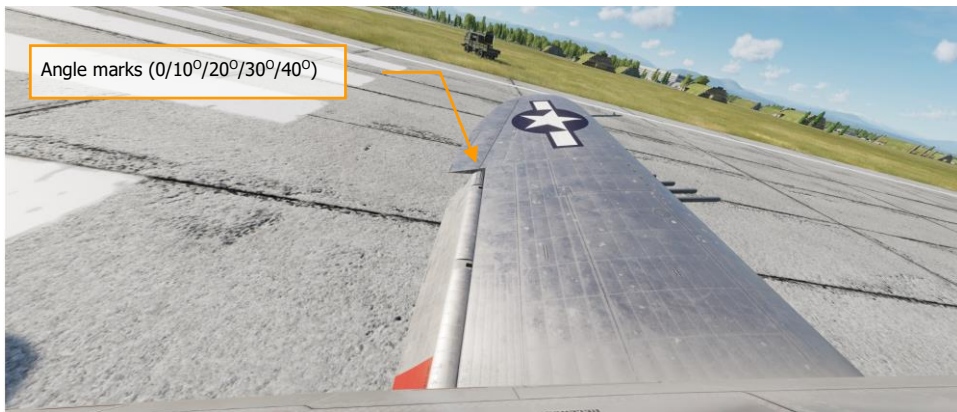

Figure 35. Angle marks

Trim tabs control unit

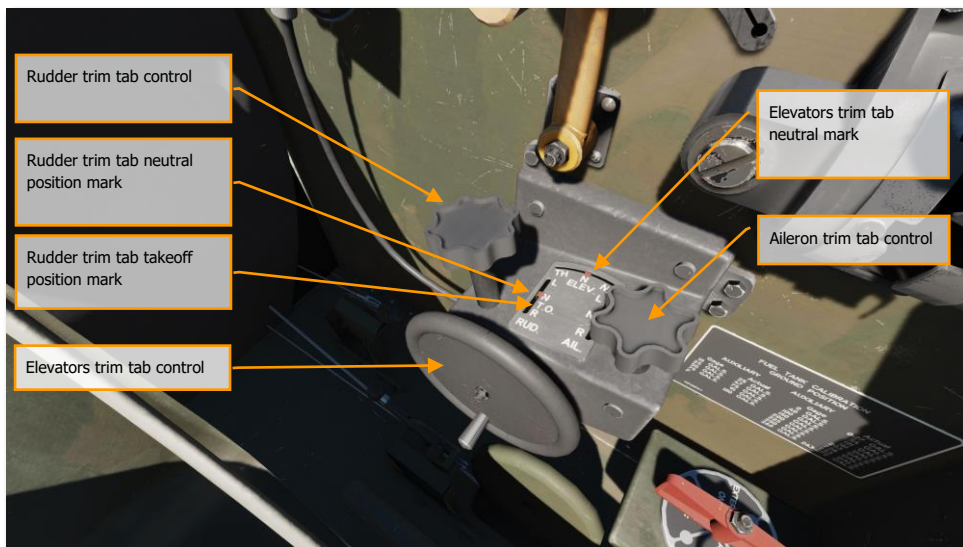

Figure 36. Trim tabs control unit

Elevators trim tabs control. This regulator is used to trim the aircraft in pitch. Rotate the wheel clockwise to dive. The labels TH (Tail Heavy), N (Neutral) and NH (Nose Heavy) shows the positions of the trimming surfaces. The red pointer shows the current position of the elevators trim tab.

Rudder trim tab control. This regulator controls the trim tab, which is built in the rudder trailing edge. Labels L (Left), N (Neutral), TO (Takeoff) and R (Right) indicates positions of the trim tab. The red pointer shows the current position of the rudder trim tab. During takeoff procedure, the rudder trim is set to T/O position.

Aileron trim tab control. This regulator controls aileron trim tab, installed in the left aileron trailing edge. In order to roll right, turn this regulator clockwise. Labels L (Left), R (Right) and N (Neutral) indicates positions of the trim tab. The red pointer shows the current position of the aileron trim tab.

Note. *Be careful when using trim controls. They are extremely sensitive.*

Propeller switch box

Propeller control on the P-47D-30 is done by means of a lever, installed in the throttle quadrant and by a small propeller box, located on the left side of the instrument panel, where circuit breaker and propeller mode switch are installed.

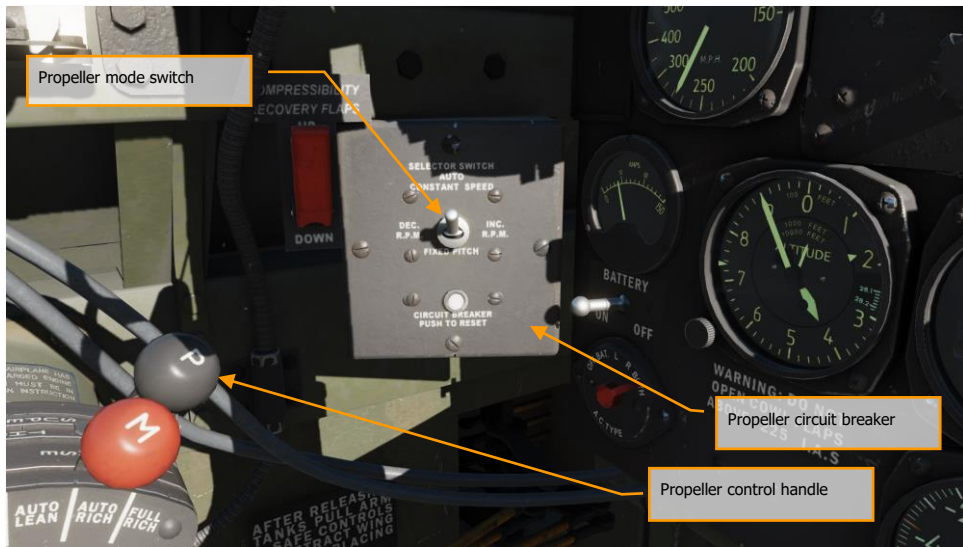

Figure 37. Propeller switch box

AUTO CONSTANT SPEED switch has 4 positions:

- **AUTO CONSTANT SPEED.** In this position the propeller governor automatically maintains engine rpm as set at the quadrant by, handle, marked as P - Propeller.
- **INCREASE RPM.** This position is not fixed and increases propeller pitch.

- **DECREASE RPM.** This position is not fixed and decreases propeller pitch.
- **FIXED PITCH.** In this position propeller governor maintains engine RPM as set by the INCREASE/DECREASE positions.

Compressibility recovery flaps control

This switch is used to extend or retract special flaps (dive flaps), which are located in the under surface of each wing just outboard of the landing gear shock strut. Switch has 2 positions:

- **UP.** Retracts recovery flaps.
- **DOWN.** Extends recovery flaps.

The angle of deviation of recovery flaps is 21°.

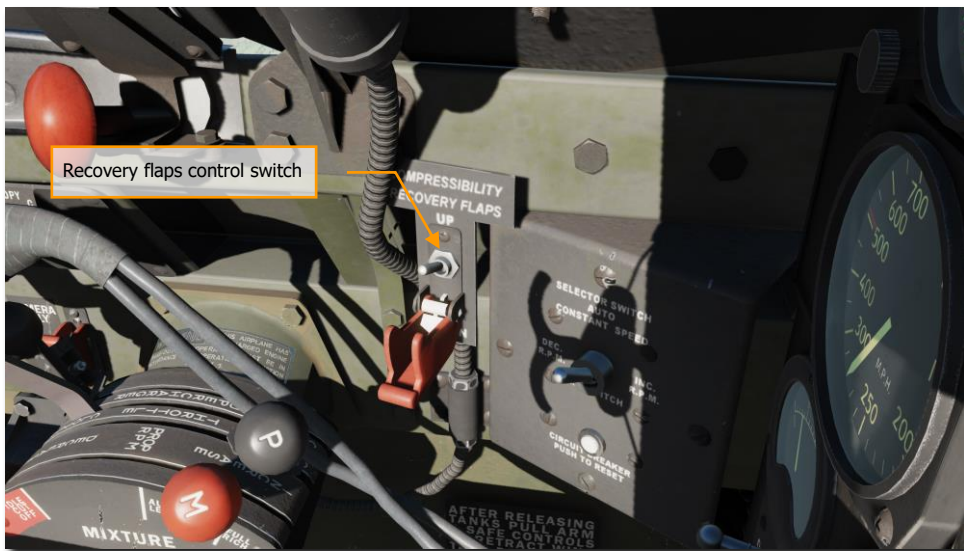

Figure 38. Compressibility recovery flaps control switch

Main switch panel

There are circuit breakers for the different systems with electric control on this panel. The rheostats control the brightness of the gunsight, compass, Gauges, symbols illumination. You also can control external lights and landing light, which is installed in the lower surface of the left-wing panel.

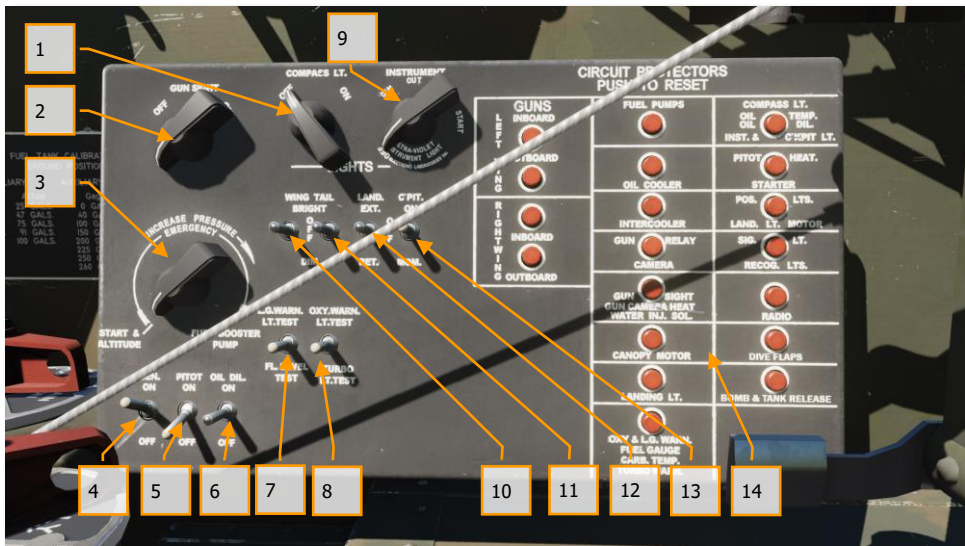

Figure 39. Main Switch Panel

1. Compass light rheostat.
2. Gunsight brightness rheostat.
3. Fuel booster pump rheostat.
4. Generator switch.
5. Pitot heater switch.
6. Oil dilution switch.
7. Fuel level/Landing gear light test switch.
8. Oxygen warning light/turbosupercharger overspeed light test switch.
9. Instrument light switch.
10. Navigation lights switch (Wing).
11. Navigation lights switch (Tail).
12. Landing light switch. With this switch, the landing light mounted under the left wing can be retracted/extended. The maximum speed of the aircraft when the landing light can be extender is 200 mph.
13. Cockpit light switch.
14. Different circuit breakers (Push to reset).

Fuel selector valve

The selector valve for switching fuel tanks selects the fuel tank from which fuel will be fed into the engine. The valve has four fixed positions:

- **MAIN.** Switching on the main tank booster pump.
- **AUXILIARY.** Switching on fuel supply and auxiliary tank pump.
- **EXTERNAL.** Turning on the fuel supply from external fuel tanks. In this position you can select desired external fuel tank from which fuel will be fed into the engine.
- **OFF.** Cut-off of fuel supply and disables all fuel pumps.

Note. The short shoulder of the selector handle is indicative.

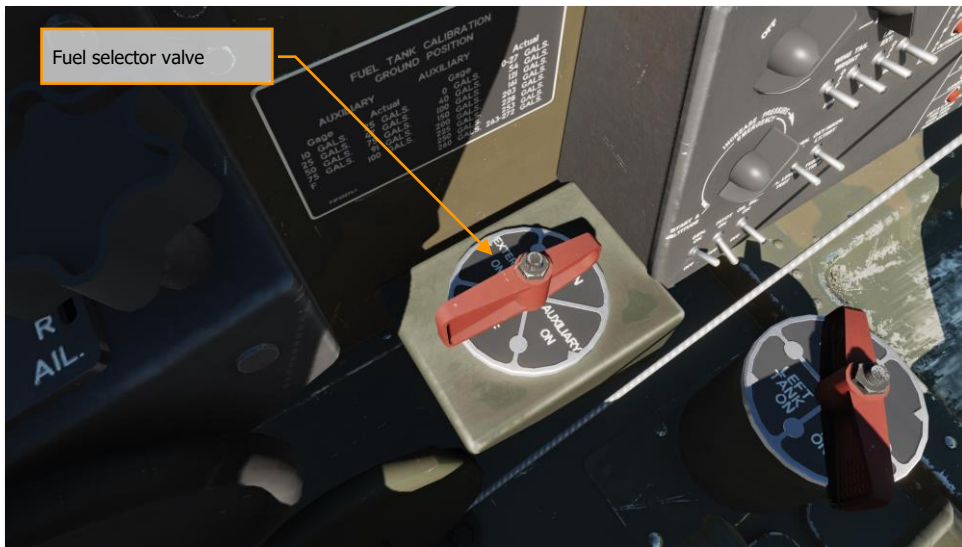

Figure 40. Fuel selector valve

External fuel tanks selector valve

This valve controls fuel flow from three external fuel tanks and has 4 positions:

- **OFF.** Disconnecting the fuel supply from external fuel tanks.
- **BELLY.** Switching on the fuel supply from the "Belly" tank.
- **RIGHT TANK.** Switching on the fuel supply from the right-wing external fuel tank.
- **LEFT TANK.** Switching on the fuel supply from the left-wing external fuel tank.

Note! The short shoulder of the selector handle is indicative.

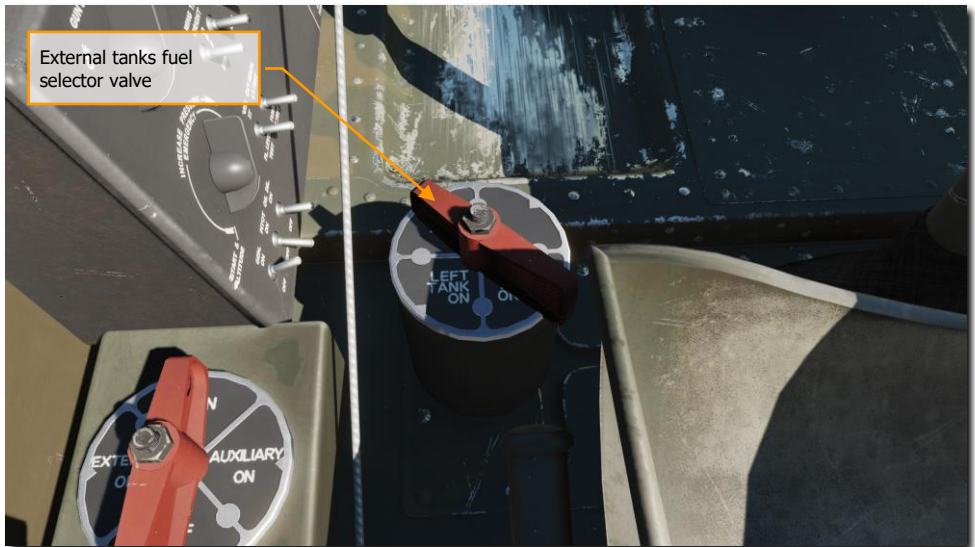

Figure 41. External fuel tanks selector valve

Canopy switch, intercooler and oil cooler shutters switches

CANOPY switch. Controls the opening and closing of the aircraft canopy. Switch can be set and held in CLOSE position when you need to close the canopy. Set this switch to OPEN position and wait for the canopy to open completely.

INTRCLR switch. This switch is used to control intercooler shutters and has 3 positions:

- **OFF.** Stops and fixes intercooler shutters.
- **OPEN.** Opens intercooler shutters.
- **CLOSE.** This position is used to close intercooler shutters.

OIL CLR switch. This switch acts the same as INTRCLR switch and is used to open/close oil cooler shutters.

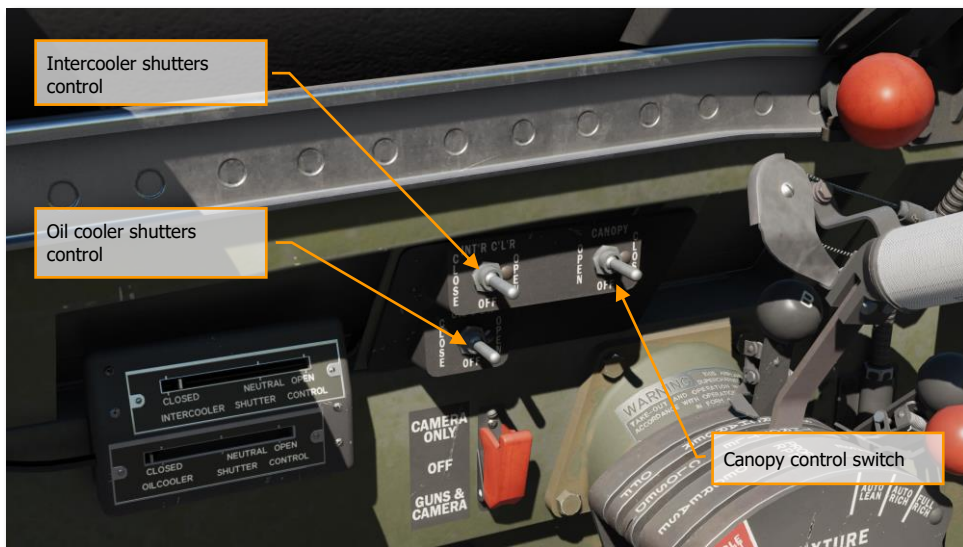

Figure 42. Port side. Intercooler/oil coolers shutters controls, canopy control switch

Instrument panel

Most instruments, except for the oxygen supply control and hydraulic pressure gauge (which are located on the separate panel), are mounted on the anti-vibration spring-loaded panel in front of the pilot's seat.

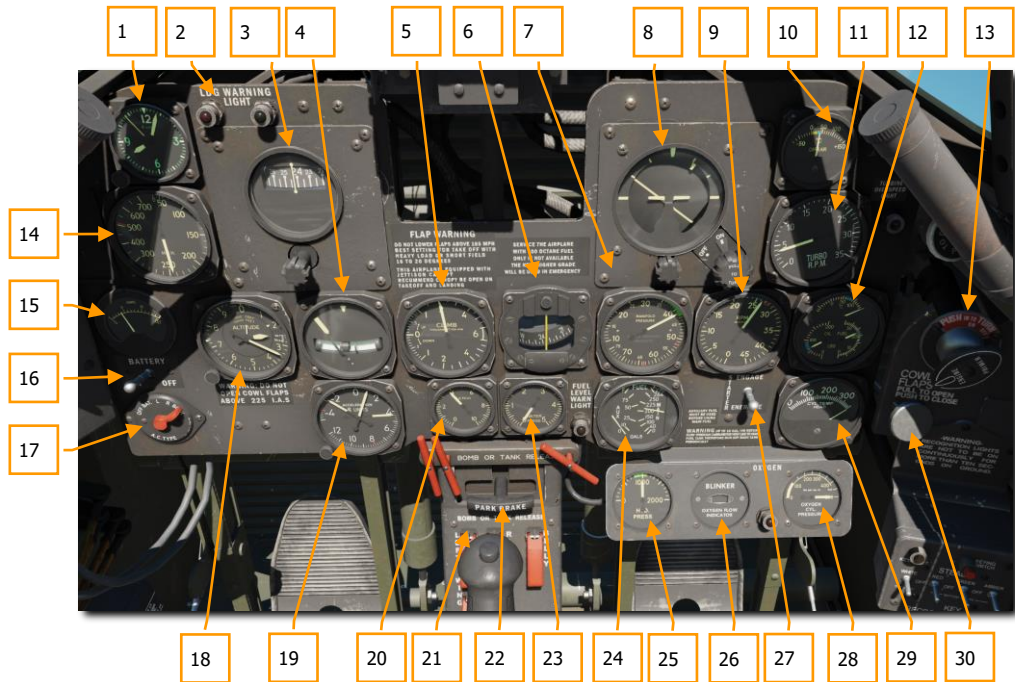

Figure 43. Instrument panel

1. Clock
2. Landing Gear Warning Lights
3. Turn Indicator
4. Bank and Turn Indicator
5. Rate of Climb Indicator
6. Compass
7. Manifold Pressure Gauge
8. Artificial Horizon
9. Tachometer
10. Carburetor Air Temperature Gauge

11. Turbosupercharger tachometer and turbo overspeed warning light
12. Engine Gauge Unit
13. Primer.
14. Airspeed Indicator
15. Ammeter
16. Battery control switch
17. Ignition Switch
18. Altimeter
19. Accelerometer
20. Suction Gauge
21. Bomb and Tank Release Controls
22. Parking Brake Control
23. Water Pressure Gauge
24. Fuel Quantity Gauge
25. Hydraulic Pressure Gauge
26. Oxygen Flow Indicator
27. Starter Switch
28. Oxygen Pressure Gauge
29. Cylinder Head Temperature Gauge
30. Cowl flaps control

Clock

The clock is installed in the upper left section of the instrument panel. The winding knob is used to set the time. To operate the knob, pull the knob out with a left mouse button click and roll the mouse wheel to set the time, then return the knob into the pressed position with another click of the left mouse button.



Figure 44. Clock

Landing gear warning lights

These light indicators provide a light indication of the position of the landing gears. When the green light is on, the gears are down and locked.

The red lamp will be lit if:

1. Landing gears are not locked
2. Landing gears are not down with the throttle $\frac{3}{4}$ closed.

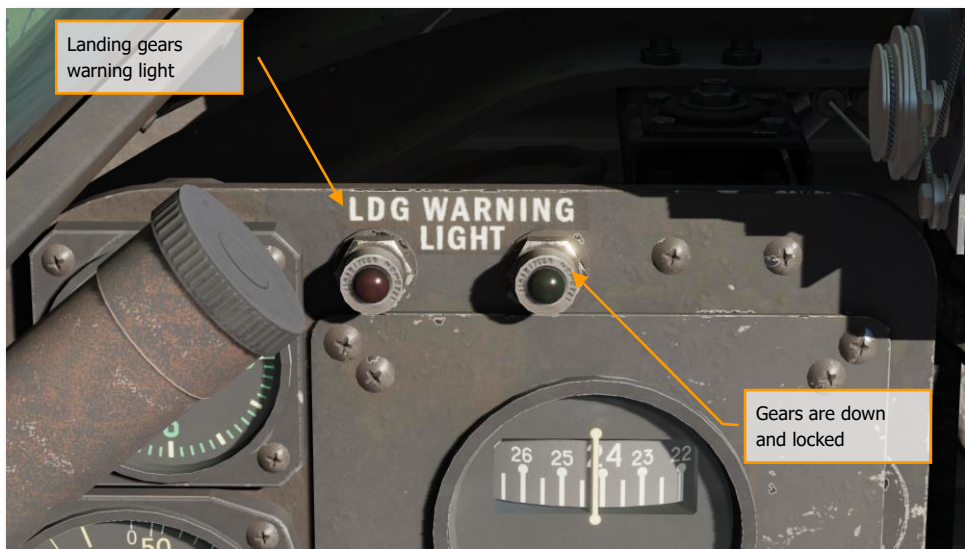

Figure 45. Landing gear warning lights

Directional Gyro

The Directional Gyro Indicator is used to supplement the magnetic compass in maintaining the aircraft on a straight course. The indicator is nonmagnetic. Relative movement of the aircraft from right to left shows on the circular card which is graduated in degrees the same as a compass card. Indicator is equipped with a cage knob. The Gyro Indicator is uncaged for normal operation. The instrument can be caged to manually rotate the heading card. To cage the instrument, click on the caging knob to push it in and rotate the mouse wheel to adjust the heading. It requires an initial alignment and can easily lose its initial orientation when maneuvering intensively. Therefore, it requires regular alignment in flight.

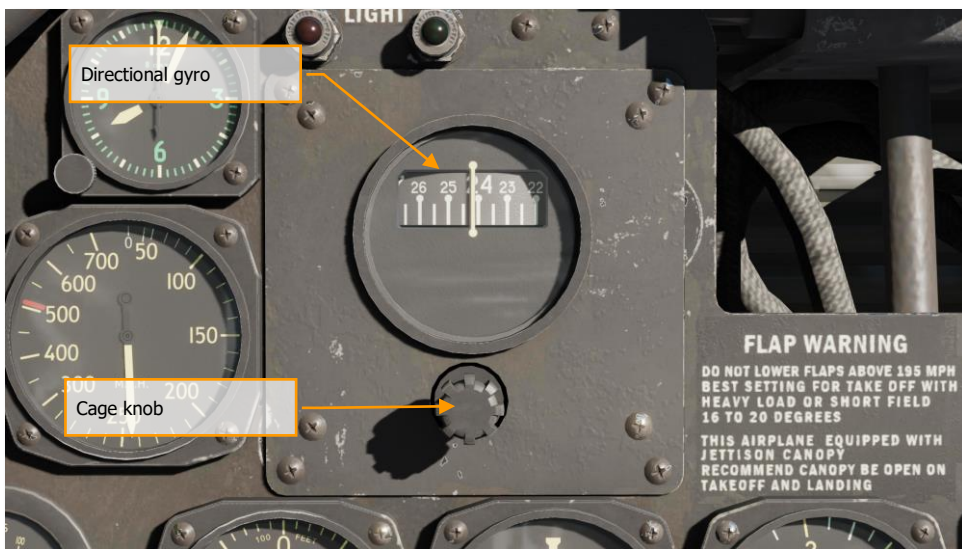

Figure 46. Directional gyro

Bank and Turn Indicator

The bank-and-turn indicator is composed of a gyroscope-type turn indicator and a ball-type bank (slip) indicator.

The bank indicator is a liquid-filled curved tube in which a free-rolling inclinometer ball changes position according to the direction of the force of gravity and centrifugal force. The bank indicator is used to minimize side-slip by keeping the ball centered between the center reference lines while turning. This instrument has no caging knob. To minimize sideslip in flight, hold the ball between the two marks in the center.

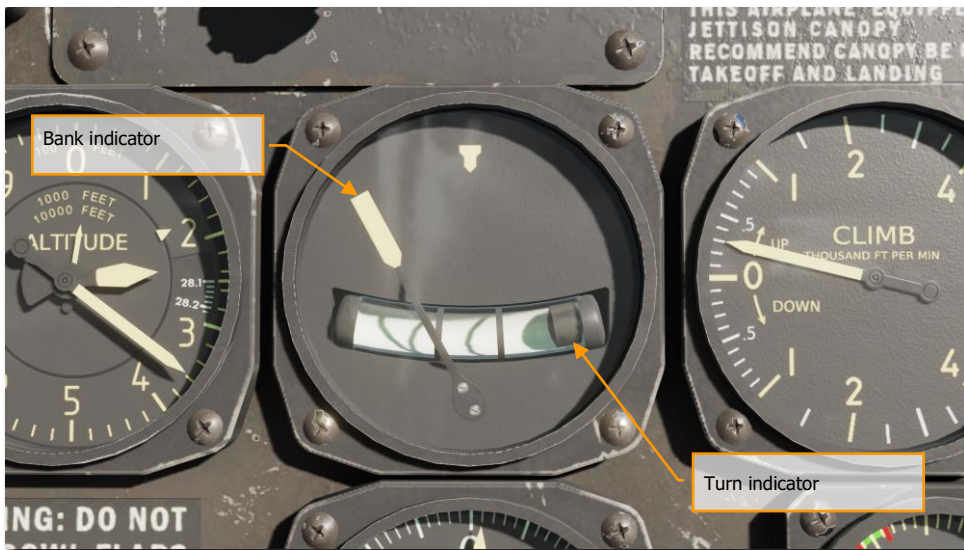

Figure 47. Bank and turn indicator

Rate of Climb Indicator

The AN5825 Rate of Climb Indicator shows the rate of ascent or descent of the aircraft. The instrument is graduated from 0 to 6,000 ft. in both positive and negative directions and indicates vertical speed in feet per minute. The face is scaled to 100 ft between 0 and 1,000 ft, and to 500 ft thereafter. The Rate of Climb Indicator is used to maintain a constant altitude when turning and to establish a definite and constant rate of climb or descent when flying on instruments.



Figure 48. Rate of climb indicator

Compass

The magnetic compass is used as an auxiliary tool during the flight to check the correct orientation of the gyrocompass.

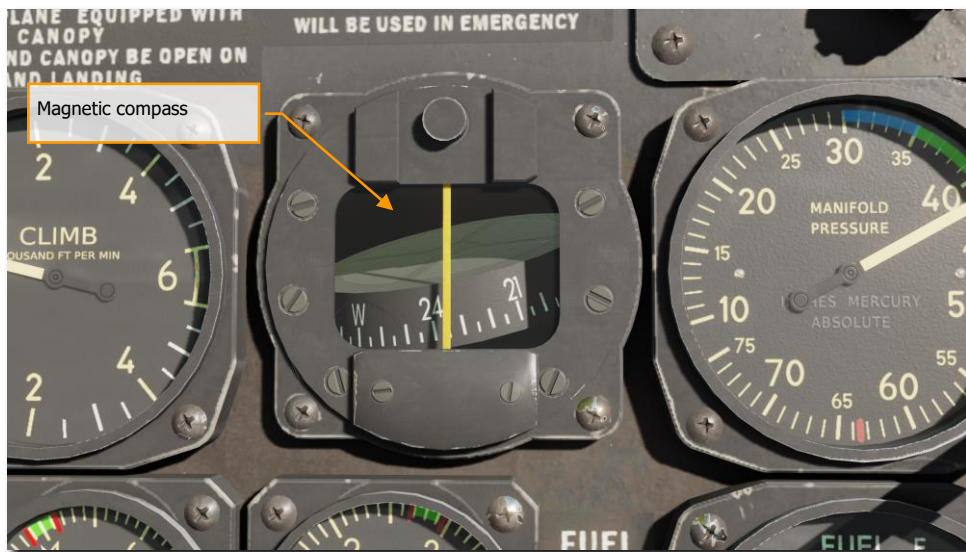

Figure 49. Magnetic compass

Manifold pressure gauge

The Manifold Pressure Indicator is used to set the desired engine power setting by adjusting the throttle and boost (turbosupercharger) control handle.

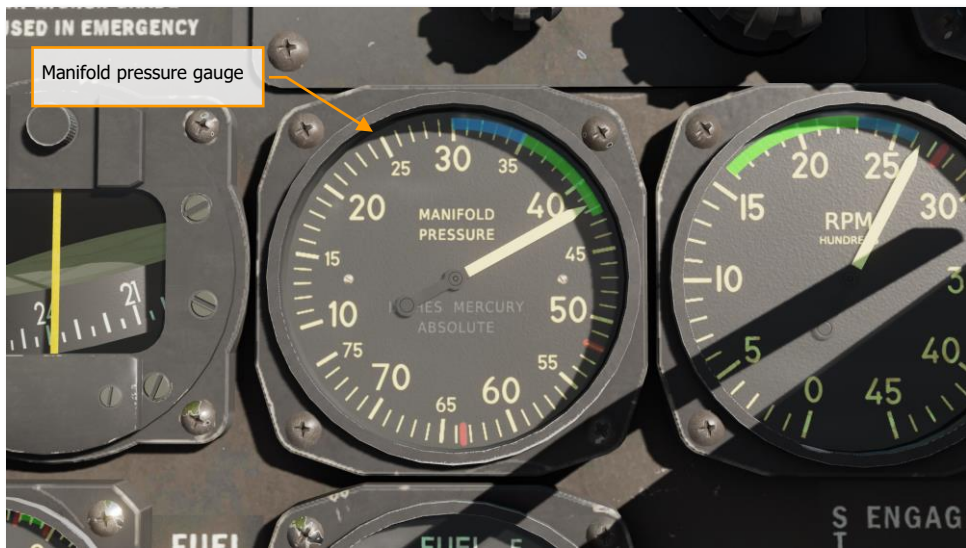

Figure 50. Manifold pressure Gauge

The Manifold Pressure Indicator is a vapor proof, absolute-pressure instrument. The gauge measures pressure in inches of mercury (inHg) and is graduated from 10 to 75 inHg. The face is scaled to 1 inHg. The green range indicates the normal operating range of 32-45 inHg. The red line indicates War Emergency Power of 64 inHg.

Artificial Horizon

The AN5736 Flight Indicator (Gyro Horizon Indicator) indicates a miniature plane and a gyro-actuated horizon bar. This instrument is used during instrument flying to indicate the longitudinal and lateral attitude of the aircraft. The horizon bar will indicate pitch up to 60° and bank up to 100° . The top needle of the instrument indicates the angle of bank on the bank scale, graduated from 0° to 90° and scaled to 30° . The cage knob is used to cage the instrument. To operate the cage knob, left-click on it to pull the knob out and roll the mouse wheel to turn it clockwise to the caged position. To uncage the instrument, roll the mouse wheel over the knob to turn it counter-clockwise. The horizon knob is used to adjust the horizon level. To operate the horizon knob, place the mouse over the knob and roll the mouse wheel to set the horizon higher or lower.

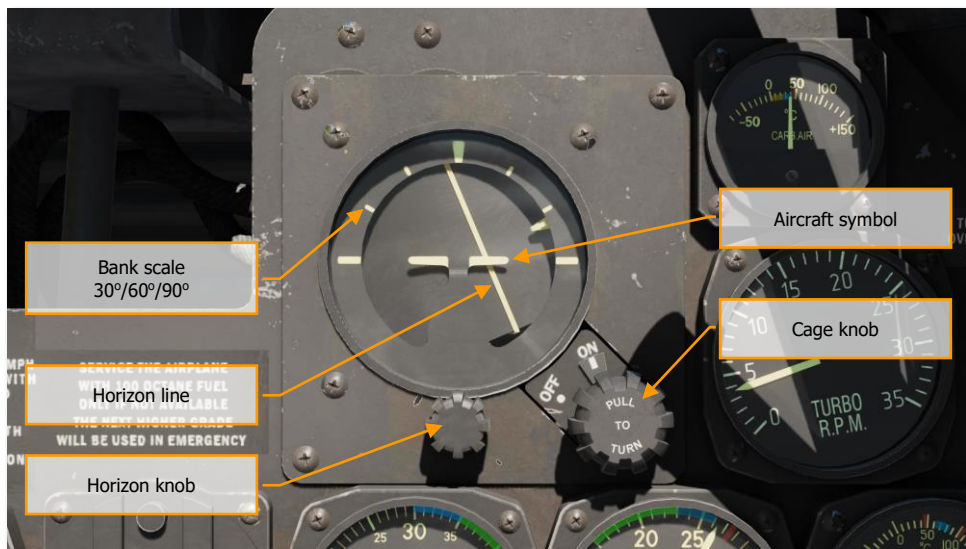

Figure 51. Flight indicator

Tachometer

The Tachometer provides remote indication of engine speed. The instrument is graduated from 0 to 4500 and indicates engine speed as Revolutions Per Minute (RPM) in hundreds of RPM. The face is scaled to 100 RPM throughout. The green range indicates normal operating RPM of 1600 - 2300. The red line indicates maximum normal RPM of 2750. Manifold pressure gauge and tachometer provides complete information about current engine mode and load.



Figure 52. Tachometer

Carburetor Air Temperature Gauge

Carburetor Air Temperature Gauge measures the temperature of air passing through the carburetor air inlet. The gauge indicates temperature in degrees Celsius ($^{\circ}\text{C}$) and is graduated from -70° to 150°C . The face is scaled to 10°C . The green range indicates normal operating temperature of 10° - 20°C . The red line indicates maximum temperature of 40°C .



Figure 53. Carburetor air temperature Gauge

Turbosupercharger tachometer and turbo overspeed warning light

The aircraft is equipped with a tachometer and a turbocharger overspeed warning light. The maximum allowable turbocharger RPM is 22.000. When this mark is exceeded, a red warning light will illuminate to indicate the need to reduce turbosupercharger speed.

This gauge is used to display turbocharger speed and is graduated from 0 to 35 000 rpm. The face is scaled to 1 000 rpm.

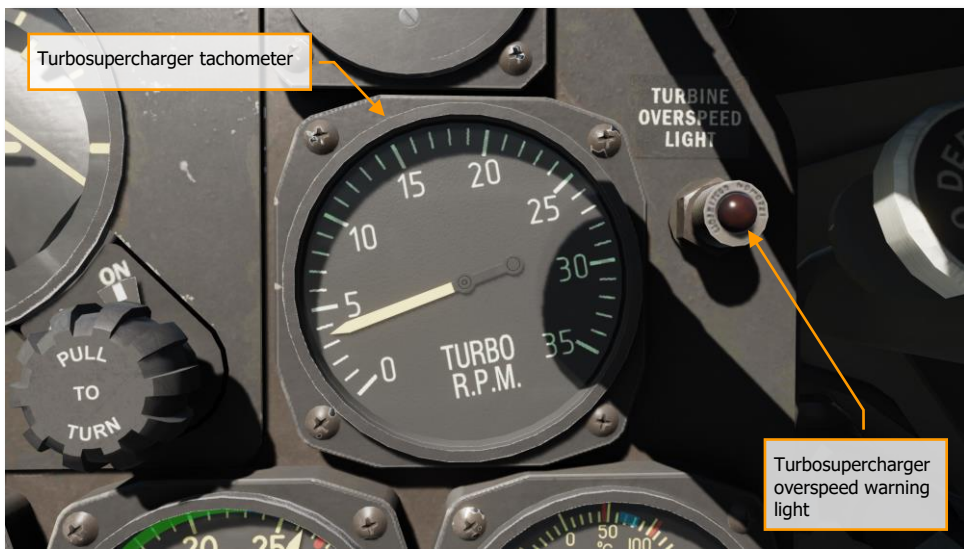

Figure 54. Turbosupercharger tachometer

Engine Gauge Unit

The engine gauge consists of three instruments in one – showing oil temperature, oil pressure and fuel pressure.

Oil temperature gauge. The Oil Temperature Gauge dominates the top half of the Engine Gauge. The gauge is graduated from -70 to 150 and indicates oil temperature in degrees Celsius (°C). The gauge is scaled to 10°. Blue line indicates normal operating temperature of 65°C - 80°C. The red line indicates maximum oil temperature of 100°C.

Oil pressure gauge. The Oil Pressure Gauge is located on the lower left side of the Engine Gauge. The gauge indicates oil pressure in pounds per square inch (PSI) and is graduated from 0 to 200 PSI. The gauge is scaled to 10 PSI throughout. The blue range indicates normal operating pressure of 60-90 PSI. The red lines indicate a minimum permissible pressure of 50 PSI and a maximum permissible pressure of 90 PSI.

Fuel pressure gauge. The Fuel Pressure Gauge is located on the bottom right side of the Engine Gauge. The gauge indicates fuel pressure in pounds per square inch (PSI) and is graduated from 0 to 40 PSI. The gauge is scaled to 1 PSI. The blue range indicates normal operating pressure of 21 - 25 PSI. The red lines indicate a minimum permissible pressure of 21 PSI and a maximum permissible pressure of 25 PSI.

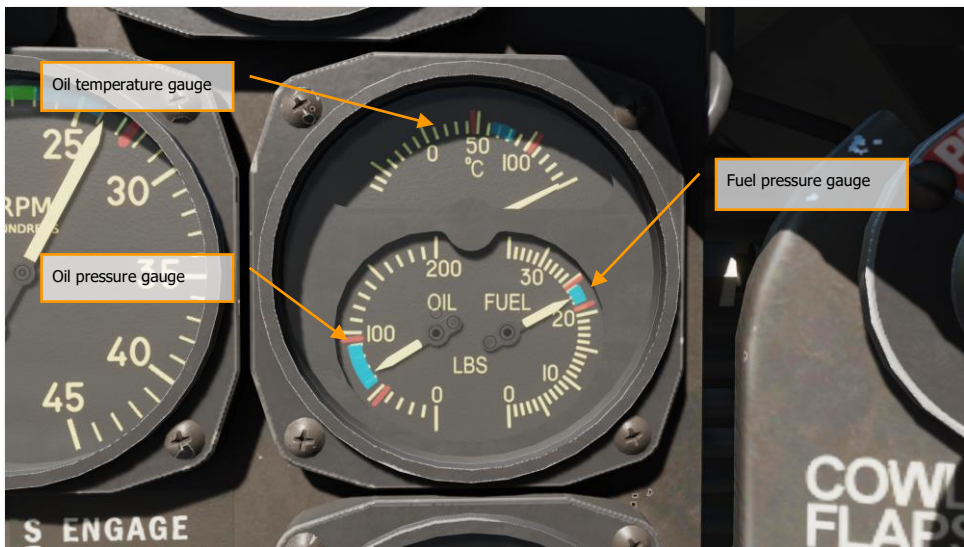

Figure 55. Engine gauge

Ammeter

The ammeter is located on the instrument panel above the battery control switch and is used to measure the generator current. Gauge is graduated from 0 to 150A and scaled to 10A.



Figure 56. Ammeter

Airspeed Indicator

Airspeed Indicator is a sensitive differential pressure gauge that measures the difference between pitot tube impact air pressure and static air pressure. The indicator displays Indicated Airspeed (IAS) and is graduated from 0 to 700 mph. The scale is to 10 mph from 50 to 300 mph and to 50 mph thereafter. The red line indicates the maximum permissible IAS of 505 mph at an altitude of 5,000 ft and less.



Figure 57. Airspeed indicator

Altimeter

The altimeter determines the altitude at which the aircraft is flying by measuring atmospheric pressure. The instrument consists of 3 needles; the shortest needle indicates altitude in tens of thousands of feet, the medium needle indicates altitude in thousands of feet, and the long needle indicates altitude in hundreds of feet. For example, the image below indicates ~8 220 ft.

The instrument includes a Kollsman window on the right side of the face to indicate the sea level reference pressure in inches of mercury (inHg). The reference pressure can be adjusted by turning the reference pressure knob.

Index triangle markers are connected with a direct gear to the altimeter mechanism and pressure setting scale (Kollsman window) and show the barometric height reference, corresponding to standard atmospheric pressure (ISA).

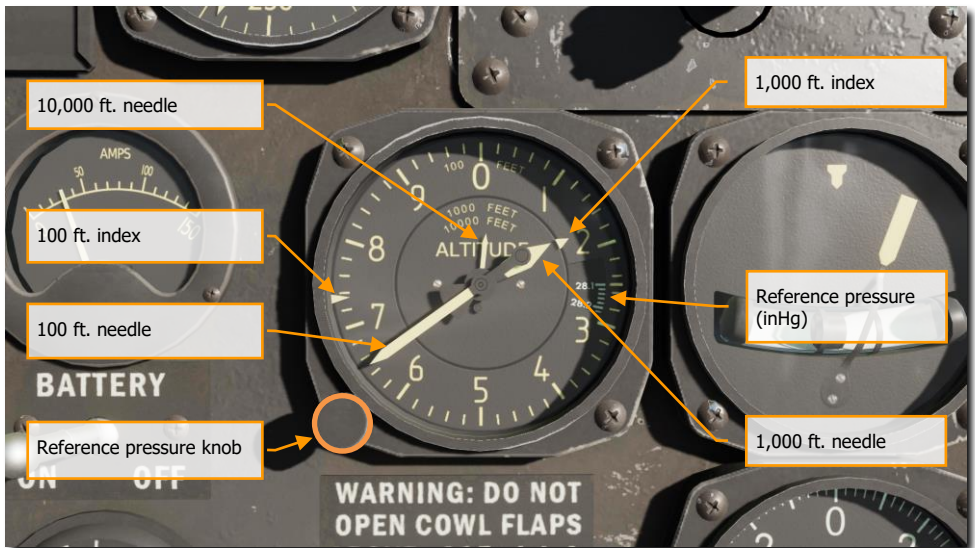

Figure 58. Altimeter

The usefulness of indexes has gradually lost its meaning with the appearance of the Kollsman barometer window at altimeters.

Accelerometer

The accelerometer indicates the load factor (G forces) acting on the plane. The gauge is graduated from -5 to 12G and is scaled to 1G throughout. The instrument includes three needles to indicate current G, and maximum and minimum G readings recorded since the last reset. The reset knob is used to reset the maximum and minimum needles. To operate the reset knob, perform a left mouse button click over it. Two red lines indicate maximum permissible loads of -4G and +8G.

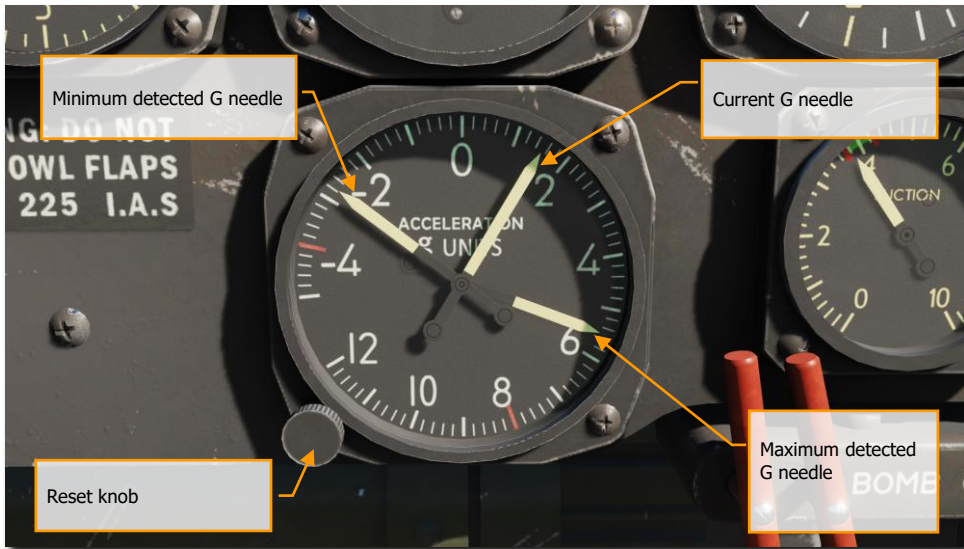

Figure 59. Accelerometer

Suction Gauge

The AN5771-5 vacuum system suction indicates whether the vacuum pump is providing proper vacuum for the system. The instrument is graduated from 0 to 10 and indicates pressure in inches of mercury (inHg). If the gauge reads less than 3.85 or more than 4.15, the pressure is abnormal and vacuum instrument readings are not reliable. Normal suction reading is 4.00 inHg.



Figure 60. Suction Gauge

Water Pressure Gauge

Water pressure Gauge indicates current pressure in the water-methanol mixture injection system. Gauge is graduated from 0 to 50 psi and is scaled to 1 psi.

The normal pressure range in the water-methanol mixture injection system is 25-27 psi.



Figure 61. Water pressure Gauge

Fuel Quantity Gauge

The fuel quantity gauge indicates the remaining fuel in MAIN (right Gauge) and AUXILIARY (left Gauge) fuel tanks. Correct indication is achieved in level flight. Main fuel tank capacity – 270 US gallons, auxiliary tank capacity – 100 US gallons.

A red warning lamp lit every time when fuel quantity in main tank is less than 40 US gallons. Remaining external tanks fuel is not measured on Thunderbolt.

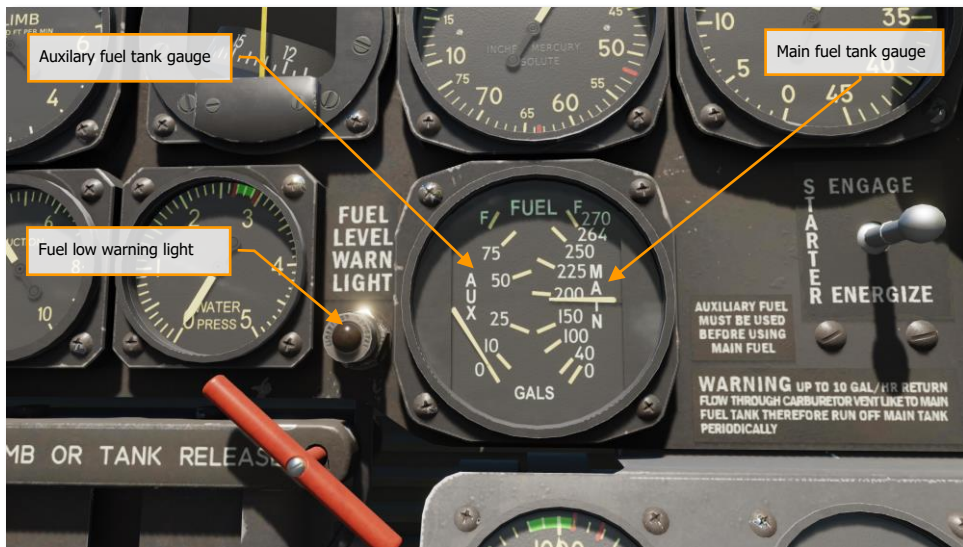

Figure 62. Fuel quantity gauge

The table on the left side of the cockpit to the right of the trimmer control unit is used to calculate the remaining fuel while the aircraft is on the ground.

Corrections table of the fuel level indicator.

Auxiliary tank (gal.)		Main tank (gal.)	
Gauge readings	Actual fuel quantity	Gauge readings	Actual fuel quantity
10	25	0	0-27
25	47	40	54
50	75	100	121
70	91	150	161
Full tank	100	200	203
		225	228
		250	253
		260	263-270

Hydraulic Pressure Gauge

The Hydraulic Pressure Gauge is located on the bottom right of the instrument panel. This instrument indicates fluid pressure in the hydraulic system, measured in pounds per square inch (PSI). The instrument is graduated from 0 to 2,000 PSI and scaled to 100 PSI throughout. Normal pressure for the hydraulic system is 800-1,100 (+/- 50) PSI.



Figure 63. Hydraulic pressure gauge

Oxygen Pressure Gauge

The Oxygen Pressure Gauge is located on the bottom right corner of the instrument panel and indicates pressure in the oxygen system. The gauge measures pressure in pounds per square inch (PSI). The instrument is graduated from 0 to 500 PSI and scaled to 50 PSI. Normal full pressure of the system is 400 PSI. Note that the oxygen pressure readings can drop as altitude increases due to the cooling of the oxygen tanks. Conversely, the pressure can increase as altitude decreases due to the warming of the tanks. A rapid decrease of oxygen pressure in level flight or during a descent is abnormal and may indicate an oxygen system leak or malfunction.



Figure 64. Oxygen pressure gauge

Cylinder Head Temperature Gauge

This device is used to control the temperature of cylinder head. The gauge is graduated from 0 to 400°C. It is scaled to 10°C.

Normal temperature of cylinder head on the ground is about 150°C, in flight – about 200°C. Never exceed 230°C for a long time.

The cause of the temperature rise in cylinder heads can be:

- Increased boost pressure without a corresponding increase in engine rpm.
- Increasing turbosupercharger RPM before throttle.
- Reducing throttle before turbosupercharger RPM.
- Long climb at small speed, especially with cowl flaps closed.

Overcooling the engine in flight is also dangerous. Overcooling can be caused by:

- dives with open engine cowl flaps.
- long dives with throttle set to IDLE.



Figure 65. Cylinder head temperature gauge

Primer

The primer is located in right section of the instrument panel. It is used to fill combustion chamber with a small amount of fuel during engine startup.



Figure 66. Primer

In order to pump fuel into the combustion chamber:

1. Pull forward and turn the engine primer handle counterclockwise.
2. Push and pull the handle up to 4 to 6 times.
3. Lock the handle by pushing it forward and turn it clockwise.

Cowl flaps control

The cowl flaps control handle is located to the right of the instrument panel, under the primer. Pull handle to open cowl flaps. Cowl flaps can be closed by pushing handle.



Figure 67. Cowl flaps control handle

Note! The Thunderbolt has no cowl flaps position indicator. However, its position is clearly visible from the cockpit.

Battery control switch

Connects and disconnects the battery.

OFF. Battery is off.

ON. Battery is on.



Figure 68. Battery control switch

Starter Switch

The Starter switch is used to start the engine. The switch is spring-loaded and needs to be held in any of the positions. It is located on the instrument panel under the engine tachometer and has 3 positions:

- **Middle position.** Starter is off.
- **ENGAGE.** Engages flywheel with the engine.
- **ENERGIZE.** Starts flywheel spinning.



Figure 69. Starter switch

Do not hold the starter control switch in the ENERGIZE position for more than 20 seconds to avoid overheating the starter motor.

Ignition Switch

This switch selects the magneto to be used to power the engine ignition system. Switch has four positions: OFF, Right, Left and BOTH.

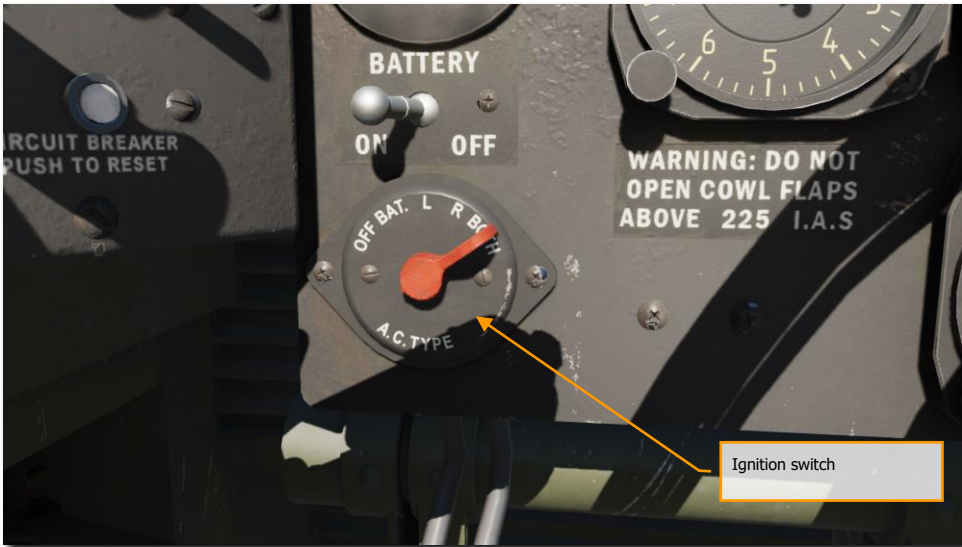

Figure 70. Ignition switch

OFF (disabled). Magneto is off.

- **R.** The right magneto is used to start the engine.
- **L.** The left magneto is used to start the engine.
- **BOTH.** Both magnetos are used to start the engine.
- **OFF.** The magnetos are turned off.

Normally both magnetos are used to start the engine.

Parking brake handle

The parking brake handle is located in the front, behind the control stick.



Figure 71. Parking brake handle

To engage the parking brake, pull the parking brake handle out, depress the brake pedals, release the brake pedals, and then release the parking brake handle. To release the parking brake, simply depress the pedals.

Never set the parking brake when the brakes are hot. The brake discs may freeze.

Bomb and Tank Release Controls

This panel consists of external tanks release handles, parking brake handle, bomb or fuel tank release switches, and two switches, which are used to release chemical containers with smoke or tears gas or other gases.

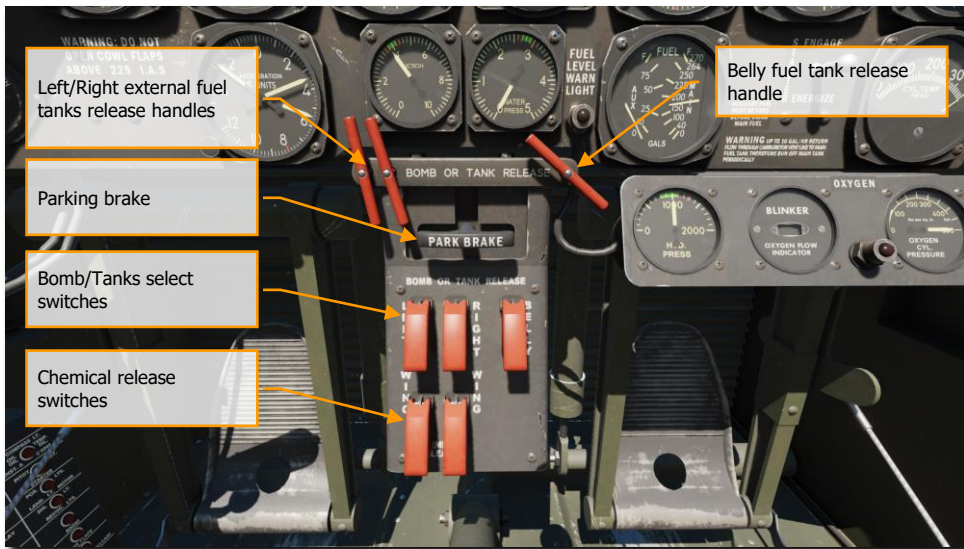

Figure 72. Bomb and tanks release control panel

Pull red thin handles located in the top left corner to release left or right external fuel tanks when they are empty. Pull red thin handle located in the top right corner to release belle fuel tank.

You can either select bombs/tanks stations using switches:

LEFT. This switch is used to arm/select bomb/tank, installed on the left-wing station.

RIGHT. This switch is used to arm/select bomb/tank, installed on the right-wing station.

BELLY. This switch is used to arm/select bomb/tank, installed on the belly station.

Bomb/Tank release is done by pressing Release button on the control stick.

WING switches are used to select chemical containers with smoke or tears gas or other gases, installed on left/right wing stations.

Note! Chemical munitions are not implemented in DCS: P-47D-30.

Starboard side

There are various radio communications, oxygen and light equipment located on the starboard side.

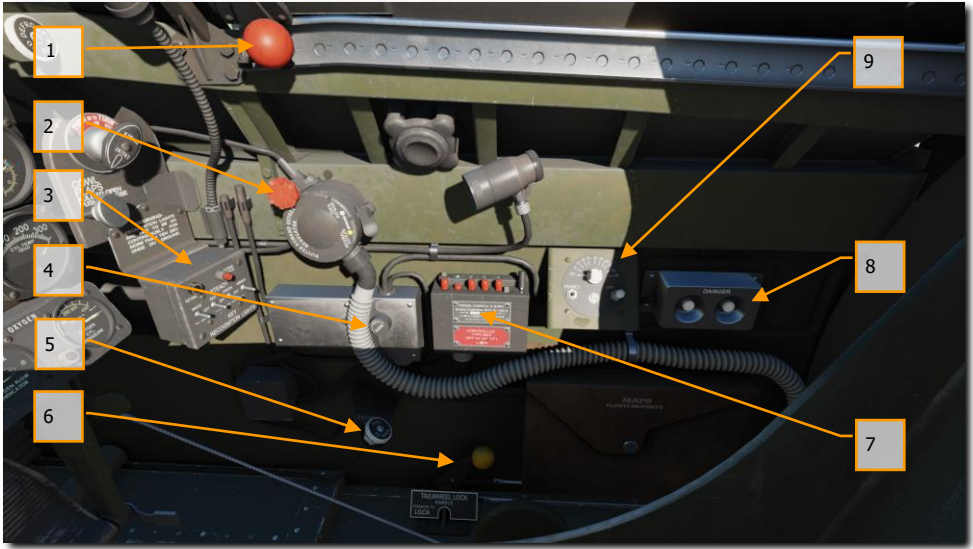

Figure 73. Starboard side of the cockpit

1. Canopy handle
2. Oxygen regulator
3. Recognition lights panel
4. Radio receiver volume control
5. Cockpit vent control
6. Tail wheel lock control
7. SCR-522-A VHF Radio
8. Secret radio detonator
9. Radio range receiver

Oxygen regulator

The AN6004 oxygen regulator is installed on the right side of the cockpit, just aft of the instrument panel. The oxygen regulator has a diaphragm which actuates a valve, permitting oxygen to flow through the regulator, where it mixes with free air in varying amount in accordance with barometric pressure. A control valve allows the pilot to close the air intake, thus causing pure oxygen to flow to the mask. The regulator also has an emergency valve, which causes oxygen to by-pass the regulator and flow directly to the mask. A feed line directs oxygen to the Oxygen Flow Blinker indicator to show when the regulator is functioning.

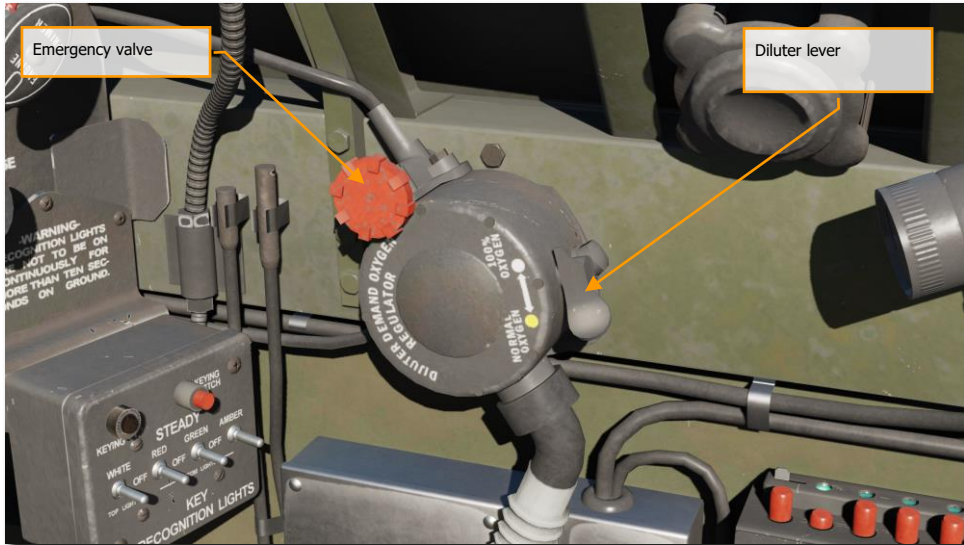

Figure 74. Oxygen regulator

Diluter lever. The Diluter lever is located on the side of the regulator case and may be positioned to NORMAL OXYGEN or 100% OXYGEN. The Diluter lever manually operates the air shutoff valve, allowing the regulator to deliver pure oxygen when the lever is in the 100% OXYGEN position. During normal operations, the Diluter lever should be left in the NORMAL OXYGEN position to allow air and oxygen to mix in the proper proportions for any given altitude.

Emergency valve. The regulator has an independent oxygen emergency valve. When the valve is turned counterclockwise, a continuous stream of oxygen is allowed to by-pass the regulator and flow to the mask.

Recognition lights panel

This panel controls three colored lamps located under the right wing.

When RED / GREEN / AMBER switches are in the middle position, the lamps are off. Setting the switches to the upper position enables steady glow mode for the corresponding lamp.

Switches can also be set to the lower position (KEY). The KEYING SWITCH is used to turn the recognition lights on and off when the lights are set to KEY position.



Figure 75. Recognition lights panel

The combination of colors as well as the light code is informed to the pilot immediately before the flight.

Note. The white fuselage identification light is not installed on the P-47D-25 and up.

Do not operate the recognition lights for over 10 seconds continuously on the ground. This may result in melting the plastic lens due to heat.

Tail wheel lock control

This lever is located to the right of the pilot's seat and is used to lock/unlock tail wheel:

- **FORWARD.** Tail wheel will be locked.
- **BACKWARD.** Unlocks tail wheel.

The tail wheel must always be unlocked during taxi. For better visibility in front of the plane pilot must steer from side to side all the time.



Figure 76. Tail wheel lock control handle

SCR-522-A VHF Radio

The SCR-522-A command radio is a push-button controlled transmitter-receiver that operates in the 100 - 156 MHz band and is used for radio homing and two-way voice communication. The control box is located just aft of the electrical control panel on the right side of the cockpit. A microphone button is located on the throttle handle. The radio operates on one of four preset frequency channels. The frequency of each channel is set in the mission editor by the mission designer and cannot be changed in flight. The desired channel is selected in flight by the pilot using the Channel Selector buttons. A Mode switch is provided that allows the pilot to select remote operation (REM) using the throttle Mic button, continuous reception (R), or continuous transmission (T).

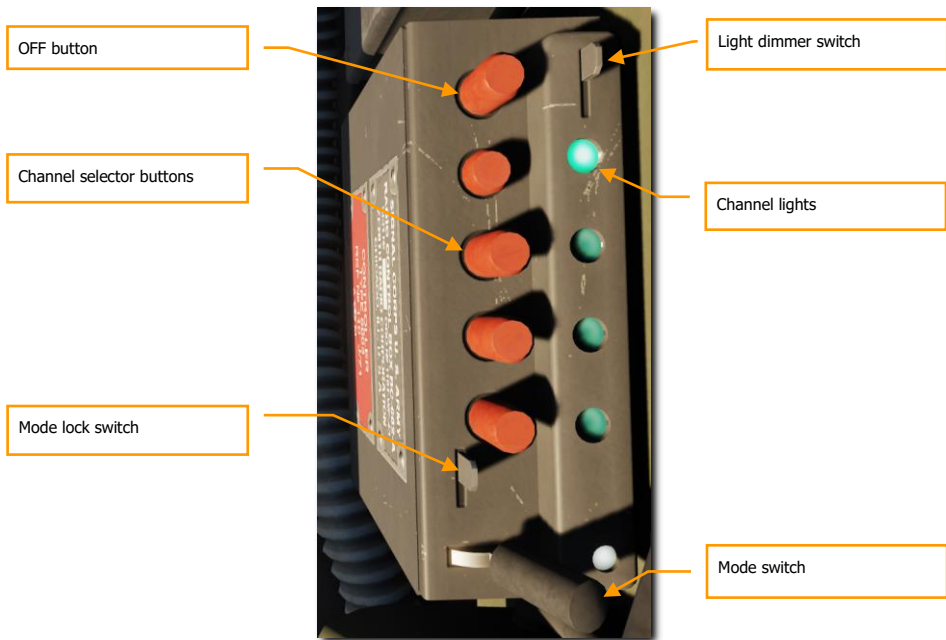

Figure 77. VHF radio control unit

LIGHT DIMMER SWITCH. The Light Dimmer switch is used to cover the Selected Channel lights with a dimmer cap to minimize light glare in the cockpit.

OFF BUTTON. When pressed down, the OFF button disables the radio.

CHANNEL SELECTOR BUTTONS. The Channel Selector buttons are used to set the channel for reception and transmission. Only one channel can be selected at a time.

"A" channel is usually used for all normal plane-to-plane communication or for plane-to-ground communication with a Controller.

"B" channel is common to all VHF-equipped control towers. It is normally used to contact the control tower for takeoff and landing instructions.

"C" channel is frequently used in contacting homing stations.

"D" channel is normally used for plane-to-ground contact with D/F stations, and as a special frequency which is automatically selected at regular intervals by the action of a contactor unit.

SELECTED CHANNEL LIGHTS. The Selected Channel lights indicate when a channel is selected for reception and transmission.

MODE LOCK SWITCH. The Mode Lock switch is used to lock the Mode switch in the selected position. When the Mode Lock switch is set to the up position, the Mode switch is held in place by a locking mechanism. When the Mode Lock switch is set to the down position, the Mode switch is held in the R (receive) position and can be moved to a spring-loaded T (transmit) position to allow the pilot to transmit in case remote operation of the transmitter using the Mic button is inoperable. When released from the T position, the Mode switch reverts to the R position for continuous reception. The Mode switch cannot be set to the REM (remote) position when the Mode Lock switch is set in the down position.

MODE SWITCH. The Mode switch has three possible positions: REM (remote), R (receive), and T (transmit). When set to REM, the radio is operated by the throttle Mic button, receiving when the Mic button is released and transmitting when it is pressed. When set to R, the radio is in continuous reception mode. When set to T, the radio is in continuous transmit mode.

Radio range receiver

Because the SCR-522-A radio command set installed in the aircraft is of the Very High Frequency type, the BC-1206 "Detrola" radio range receiver is used for reception of signals in the Low Frequency range of 200 - 400 kHz. The Detrola is located towards the bottom of the right side of the cockpit, forward of the seat. The Detrola is a receiver only and does not transmit. However, reception is possible using both the Detrola and the VHF command radio simultaneously. Controls of the Detrola include the ON-OFF/Volume knob and the Tuning knob.

Note! The Detrola is not implemented in DCS: P-47D-30.



Figure 78. "Detrola" Radio Range Receiver

Control Stick

The control stick is used to control the aircraft by roll and pitch. It has a release button installed at the top of the stick and is used to drop bombs, tanks, containers and launch rockets. It also has a red trigger to fire the machine guns. Pressing the trigger fires all machine guns simultaneously.

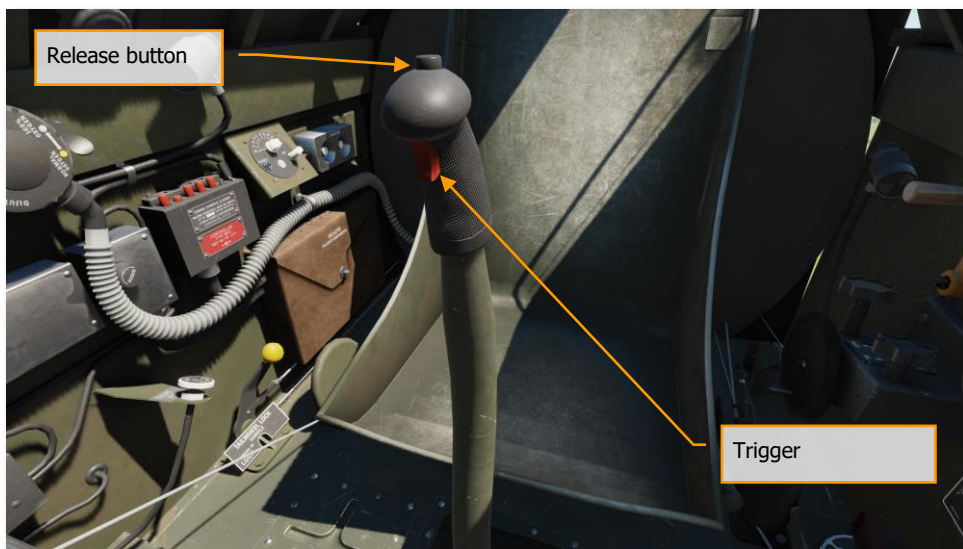

Figure 79. Control stick

Engine control quadrant

The engine control quadrant includes: throttle lever; turbosupercharger control lever; mixture control lever; propeller control lever. The turbosupercharger control lever and throttle control lever can be interconnected with each other by a spring-loaded latch for joint travel. Small button on the top of the throttle lever is used for water-methanol mixture injection. In the lower section of the throttle lever there is a small Push-To-Transmit button and is used to transmit voice messages through the VHF radio.

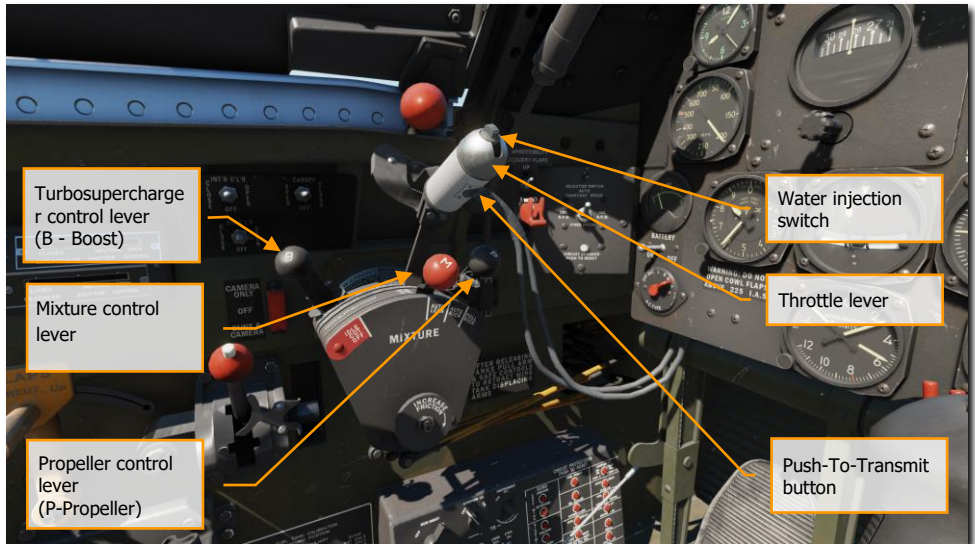

Figure 80. Engine control quadrant

Mixture control lever

Mixture lever, labeled as "M" (Mixture) is used to set the fuel/air mixture and has 4 positions:

- **IDLE-CUT-OFF**. This position is used when starting and stopping the engine. This position should be set after the engine is stopped to ensure that no fuel is allowed to enter the carburetor while the engine is not running.
- **AUTO LEAN** (Diluted mixture, AUTO). This position is used during long-range flights in cruising modes. You should keep an eye on the cylinder temperature. If the engine starts to overheat, set lever to AUTO RICH position and reduce engine RPM until cylinder temperature drop.
- **AUTO RICH** (Rich mixture, AUTO). This position is used for training and regular flights when engine cruising modes are not used.
- **FULL RICH**. This position is blocked by a safety wire and is used when the automatic mixture control is inoperative. It is necessary to reduce altitude as soon as possible and control the smokiness of the exhaust gases. The higher the smoke caused by unburned soot particles, the lower you should fly.



Figure 81. Mixture control lever (M) and propeller control lever (P)

Turbosupercharger control lever

This lever allows you to set the required manifold pressure after the throttle has been set forward to its outermost position.

Turbosupercharger is used at altitudes above 12,000 feet when air density drops significantly.

Important! *Keep in mind a simple rule - this lever cannot be set ahead of the throttle. If you need to reduce throttle, first reduce turbosupercharger RPM, then reduce engine RPM by moving throttle. Never allow the turbosupercharger lever to be set above the throttle in order to avoid engine damage or overheating.*

The automatic turbocharger regulator maintains exhaust gas pressure before the turbine. That's why pilot should constantly make a correction for the effective climbing.

Propeller control lever

This lever is used to set engine RPM by propeller governor. When propeller mode switch is set to AUTO CONSTANT SPEED, use propeller control lever to set engine RPM.

K-14 Gunsight

This section provides a detailed overview of all controls of the K-14 gunsight, which is located on top of the dashboard.

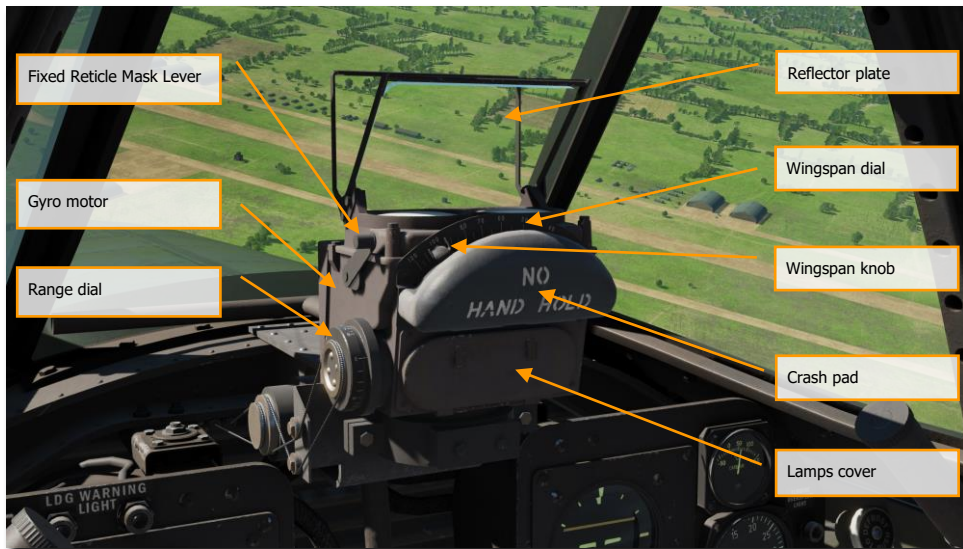

Figure 82. K-14 Computing gunsight

The P-47D-30 is equipped with the K-14 gunsight, mounted on the instrument hood centerline. This sight contains both fixed and gyro-actuated optical systems, and computes the correct lead angle for targets at ranges of 600 – 2400 feet.

The fixed optical sight system projects on the reflector glass a cross, surrounded by a 70-mil ring which can be blanked out by pulling down the masking lever on the left side of the sight. The fixed sight is used to engage ground targets and as a secondary sight against airborne targets. The gyro sight projects a variable-diameter circle of six diamond-shaped pips surrounding a central dot. The gyro sight is the primary sight used to engage airborne targets.

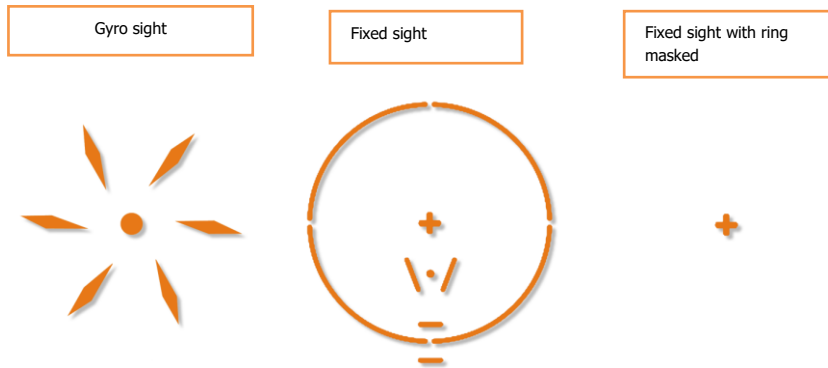

Figure 83. K-14 Sight reticles

The sight is adjusted for the size of the target by means of the wingspan scale on the front of the sight. Then range is set into the computing mechanism by rotating the range dial on the left side of the gunsight until the diameter of the gyro image coincides with the span of the target in view. Targets must be tracked for at least one second before the sight will computed effectively.

Kneboard map

To aid with navigation, a kneboard map is included in the cockpit. The map can be opened at any time in the cockpit for a quick glance by pressing and holding the **[K]** command or toggled on and off with the **[RSHIFT + K]** command. The map displays a plot of the flight plan and is initially centered on the starting waypoint. The **[]** (open bracket) and **[]** (close bracket) commands can be used to change the kneboard page, which cycles through the flight plan waypoints on the map view.

Additionally, the **[RCTRL + K]** command can be used to place a mark point on the map. A mark point indicates the location of the aircraft on the map, the aircraft's heading, and the game time at which the mark point was placed.

The kneboard can also be viewed on the pilot's left leg when the pilot is enabled in the cockpit (**[RSHIFT + P]**).



Figure 84. Kneboard map

FLIGHT CHARACTERISTICS



FLIGHT CHARACTERISTICS

Operating limitations

Speed limitations

- Do not extend landing gear and landing light at speeds in excess of 200 mph.
- Do not extend flaps at speeds in excess of 190 mph.
- Make no turns below 130 mph.
- When external tanks are installed, airspeed is restricted as follows:
 - 75 US gallon belly tank-350 mph
 - 110 US gallon belly tank-325 mph
 - 165 US gallon wing tank-300 mph

Prohibited maneuvers

- Intentional spins of more than one-half turn
- Outside loops
- Whip stalls
- Prolonged inverted flight.
- Snap rolls
- Slow rolls above 313 mph
- Slow speed turns
- When external tanks are installed:
 - Dynamic maneuvers
 - Training landings
 - High speed dives
- Tight turns or dives exceeding 225 mph are prohibited with cowl flaps open. Tail buffeting may result.

Instrument markings

Flight and engine operating limits for normal flight are included on the cockpit on a special placard. Normal ranges are marked by green/blue color, limits are marked by red color, cruise modes are marked with blue color.

NOTE! The actual operating ranges may slightly differ from those applied to the instrument scales due to the unification of the different instrument versions, used on Thunderbolts.



Figure 85. Manifold pressure gauge

- First red mark at 52 in. Hg – max. takeoff manifold pressure
- Second red mark at 64 in. Hg – war emergency power manifold pressure
- Cruise range 30 ... 35 in. HG.
- Operating range 35 ... 42 in. HG

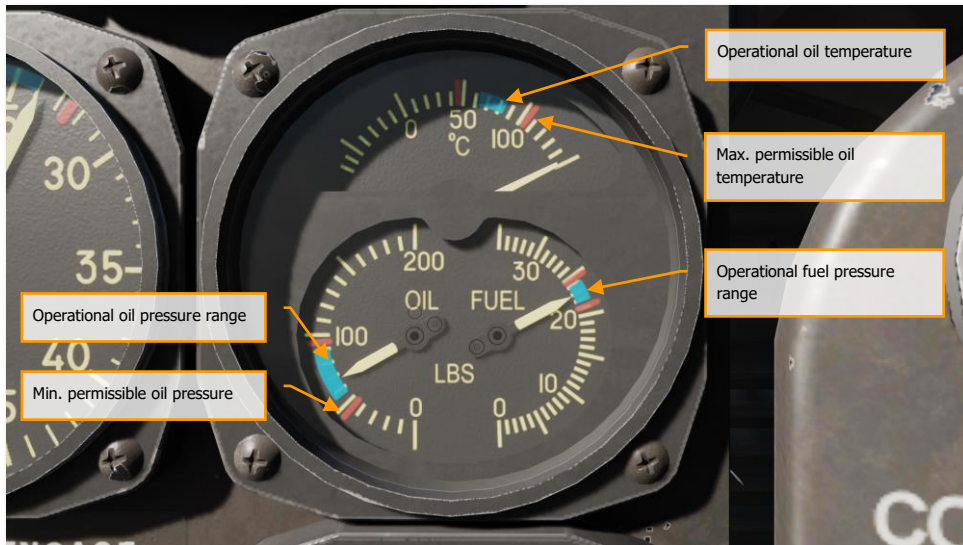

Figure 86. Engine gauge unit

Max permissible oil temperature 105°C, operating oil temperature 60°C ... 80°C.

Max permissible oil pressure 90 lbs./sq. in. Min permissible oil pressure 50 lbs./sq. in. Operating oil pressure range 60...90 lbs./sq. in.

Max fuel pressure 24 lbs./sq. in. Min permissible fuel pressure 22 lbs./sq. in. Operating fuel pressure range 22...24 lbs./sq. in.



Figure 87. Tachometer

Cruise range 1600 - 2300 RPM. Operational range 2300 - 2600 RPM. Maximum takeoff RPM – 2800.



Figure 88. Maximum permissible IAS is 505 mph



Figure 89. Carburetor air temperature operational range 0 - 40°C, max. temperature +50°C



Figure 90. Operational vacuum range— 4.00 in. Hg.



Figure 91. Operational water pressure range is 25-27PSI



Figure 92. Operational hydraulic pressure range is 800-1100PSI. Maximum hydraulic pressure - 1300PSI

Special flight conditions

External fuel tanks

When equipped with external tanks, only normal flight attitudes are permitted. Only normal climbing turns and descents should be performed when carrying drop tanks.

Low Level Flight

When flying at extremely low altitudes, the aircraft should be trimmed slightly tail-heavy to avoid dropping the nose toward the ground in case the pilot's attention is momentarily taken away from aircraft control.

NORMAL PROCEDURES



NORMAL PROCEDURES

Pre-start

As soon as you enter the cockpit, make sure that:

fuel selector valve is set to MAIN



trim tabs are set to takeoff and neutral.



flaps are UP.



Landing gears handle is DOWN.



Check:

- Turbosupercharger lever is in OFF position.

- Throttle is full aft.
- Mixture control handle is set to IDLE-CUTOFF.
- Propeller governor is set to INCREASE RPM.

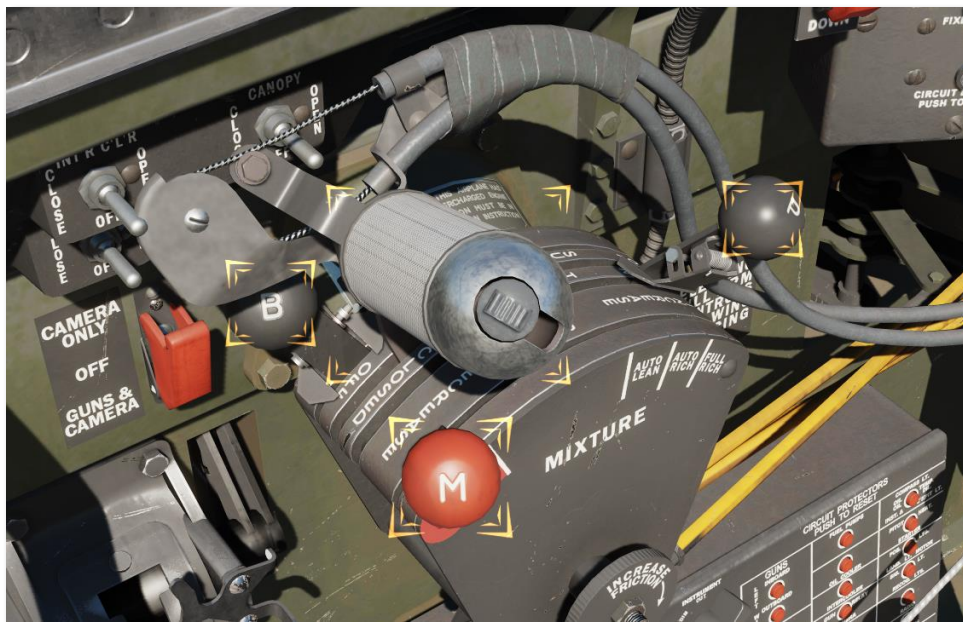

Generator switch is set to ON (main switch panel).



Propeller mode is set to AUTO CONSTANT SPEED, propeller circuit breaker is set to ON.



Ignition switch is set to OFF.



Battery is OFF.



Flight instruments are caged.

Check the performance of the manual hydraulic pump by checking the pressure increase in the hydraulic system on the pressure gauge.



Radio is off.

Set battery to ON and check all circuit breakers on main switch panel.



Check all warning lights.





Check fuel quantity gauge using corrections table.



FUEL TANK CALIBRATION GROUND POSITION			
AUXILIARY		AUXILIARY	
Gage	Actual	Gage	Actual
10 GALS.	25 GALS.	0 GALS.	0-27 GALS.
25 GALS.	47 GALS.	40 GALS.	54 GALS.
50 GALS.	75 GALS.	100 GALS.	121 GALS.
75 GALS.	91 GALS.	150 GALS.	161 GALS.
F	100 GALS.	200 GALS.	203 GALS.
		225 GALS.	228 GALS.
		250 GALS.	253 GALS.
		260 GALS.	263-272 GALS.

93F45276-1

Check oxygen pressure.

Check oil cooler and intercooler shutters and set them to NEUTRAL.



Set battery to OFF.



Fuel rheostat is set to START and ALTITUDE (full counterclockwise).



Engine startup

After completing the pre-start check, proceed with engine start-up as follows:

Set fuel selector valve in MAIN (if not set).



Move throttle one inch forward.

Set turbosupercharger lever to OFF position (if not set).

Set mixture control lever to IDLE CUT-OFF.

Set propeller governor to INCREASE RPM (full forward, if not set).

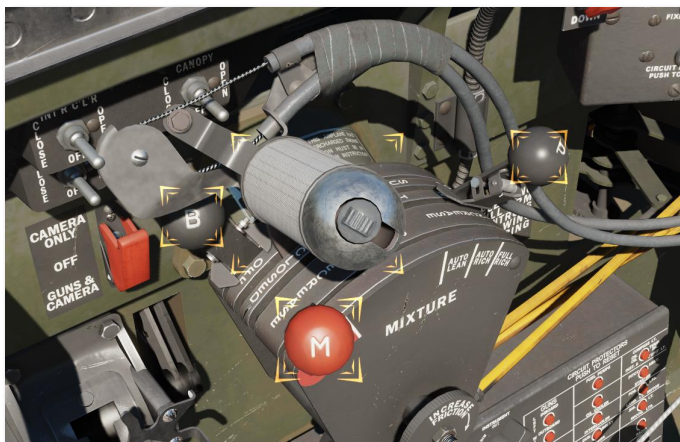

Set propeller mode switch to AUTO CONSTANT SPEED position and press prop circuit breaker, enable all circuit breaker located at the main switch panel (if not enabled).



Make sure that fuel boost pumps rheostat is set to START & ALTITUDE.



Use air filter if dusty conditions are met. Set air filter handle to ON (full forward).



Unlock primer handle by turning it counterclockwise. Then prime engine four to six times in order to pump fuel into combustion chamber. Then lock primer (set to OFF).



Set battery switch to ON.



Set ignition switch to BOTH.



Flick the starter switch up to Engage then back to Off. This seats the starter brushes.



Hold the starter switch to Energize for 15-20 seconds (until the flywheel is up to speed).



Then Engage. Look and listen for the engine to catch.



Set the mixture lever to Auto Rich and release the starter switch after a few revs.

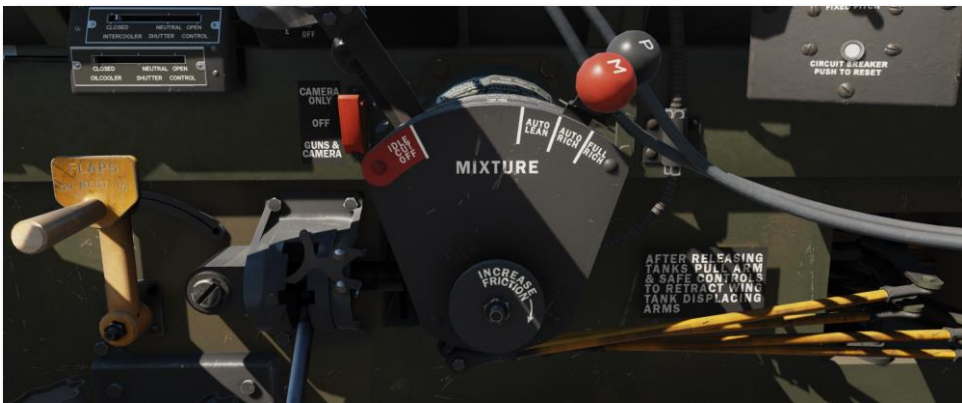

Set engine RPM ~900 by moving throttle little forward.



Enable radio by rotating AUDIO knob (to the right).



Check the oil pressure level after starting the engine (after 30 seconds). If the engine oil pressure is less than 25 psi, stop the engine. Warm-up engine at 800-1000 RPM until the oil temperature becomes is at least 40°C and the oil pressure will be constant.



Make sure that the vacuum gauge's pointer is within the values of 3,85 – 4,15 in. Hg.



When the engine starts cold, oil pressure can be 150-200 psi. Do not exceed 1000 RPM until the oil pressure stabilizes within the operational range.

Maintain engine rpm at 800-1000 RPM range until the oil temperature rises up to 40°C and above.

Taxiing

Unlock tail wheel before taxi. When the aircraft is in a 3-point attitude, the nose restricts forward visibility. This means that in taxiing, you must zig-zag (or "S-turn") continually.

Taxi with the canopy open. This not only aids visibility, but keeps the cockpit cooler on the ground.



Disable parking brake.



Taxiing with extended landing flaps is prohibited.

Preflight check

Make sure that rudder trim is set to T/O. If auxiliary tank is full, set elevator tab $\sim 1/4$ inch forward of white mark.

Make sure that mixture control is set to AUTO-RICH.



Check flaps in UP. Open cowl flaps.



Check the generator by setting the engine to 1400 RPM.

Check radio (just contact with ATC).

Takeoff

Normal takeoff

Follow the below procedure to perform a normal takeoff:

Be sure takeoff area is clear and check final approach for inbound aircraft.



Lineup for takeoff, close canopy and lock the tailwheel.

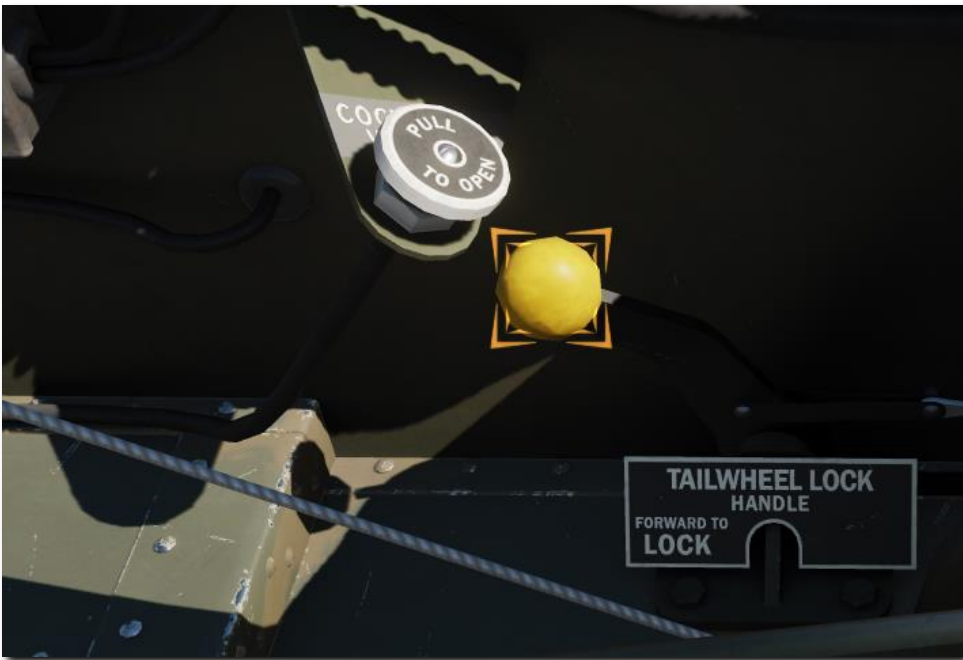

Half-flaps can assist takeoff from abnormally short airfields (20°).

Push the interconnected boost and throttle forward to approximately 30 inches Hg. while holding the airplane with the brakes. Release the brakes and with firm and even pressure open throttle to take-off.



Smoothly move interconnected throttle and turbosupercharger control to take-off mode (52" Hg).



At 110 mph pull control stick smoothly.



Note. *Half-flaps will assist take-off from abnormally short fields (20°).*

The P-47 flies off the ground from a 3-point position at about 100 mph. However, raise the tail about 6 inches. Stay on the ground until reaching a speed of around 110 mph. Then lift the plane off the runway. The raised tail and added speed give you much better rudder control in case of trouble.



Use rudder, not brake, to correct for torque on takeoff.

Develop Thunderbolt's best climbing speed – near 160 mph.



Hot weather takeoff

During takeoff in hot weather, when the air temperature is above 35 degrees Celsius, it is necessary to disconnect the throttle and turbosupercharger level (set it to OFF) and take off without using the turbosupercharger. This is done to avoid power loss or increasing the carburetor temperature. The turbocharger can be used when reaching a safe flight altitude with low carburetor temperatures.

Crosswind takeoff

The following procedure is recommended for a crosswind takeoff:

- Advance interconnected throttle and boost lever to Takeoff Power (52 in. Hg)
- Hold the tail down until sufficient speed is attained to ensure positive rudder control. Speed should be slightly greater than for normal takeoff.
- Apply sufficient aileron control to keep wings level or even to affect a slightly wing-low attitude into the wind.
- Keep the aircraft firmly on the runway until speed is sufficient to make a smooth, clean break.
- After becoming airborne, crab into the wind enough to counteract drift.

After takeoff

After safe takeoff, raise landing gear by setting red handle into UP position and check warning light come out. Always complete landing gear cycle except in an emergency.

When using the flaps during takeoff, raise landing gears as quickly as possible and develop at least 145 mph before rising flaps. Keep flaps extended until you reach 500ft altitude. Then, carefully, raise flaps by moving yellow handle to UP position. Optimum climbing speed is 150-165 mph.

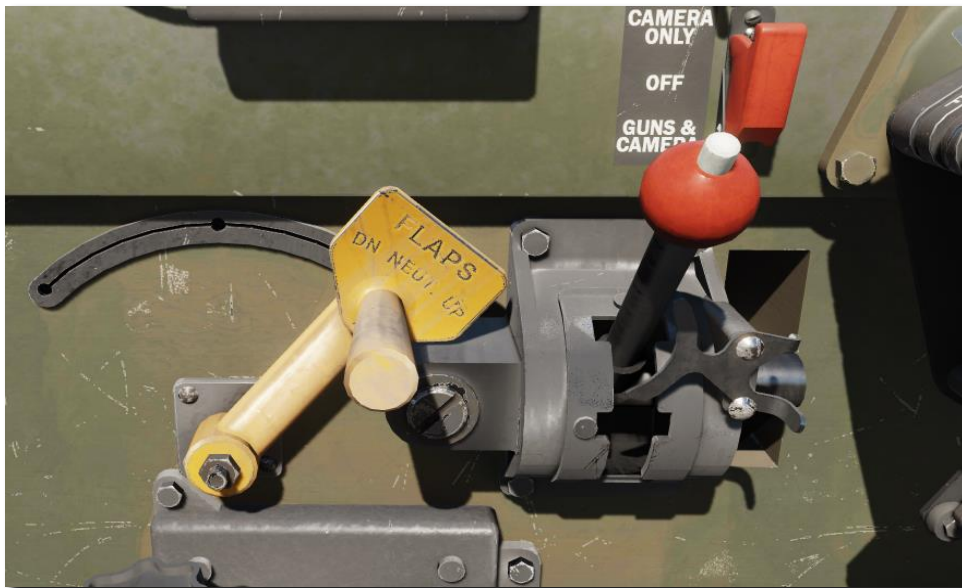

After reaching an altitude of 500 feet, throttle back to 42" of manifold.

Set the elevators trim tabs for climb and remove the load on the stick.

Check all of your instruments for proper function within normal parameters. In doing so, be sure to check the ammeter indicator showing proper charging from the generator. Immediately after takeoff, the rate of charge should not exceed 100 amps, dropping back to the normal 50 amps or less after 5 minutes of operation. If the charge does not reduce, turn the generator disconnect switch to OFF and return to the airfield. Also check the hydraulic pressure to read approximately 1000 PSI after the landing gear has been retracted.

Do not apply brakes after takeoff to stop rotation of the wheels to prevent the brake disks from seizing.

Climb

Best climbing speed is 150 to 165 mph. It will be necessary in prolonged climbs, or in hot weather, to climb at higher speed in order to properly cool the engine.

Keep cowl flaps "OPEN" and check the cylinder-head temperature frequently. If it's over 260°C, increase the airspeed. Check oil temperature ~ 95 °C, and carburetor air temperature ~35°C.

After reaching the safe altitude (near 10 minutes of flight) set the fuel selector valve to AUXILIARY for fuel consumption from the auxiliary fuel tank. The airplane has greater longitudinal stability if the auxiliary tank is empty.

External fuel tanks release procedure

1. Set LEFT/RIGHT/BELLY switch to up position on Bomb or Tank release panel
2. Press RELEASE button on Control Stick.

You can also use special red thin handles located at Bomb or Tank Release panel to release external fuel tanks. Pull red handle aft to release external fuel tank.

External fuel tanks release

External fuel tanks release can be done by rope mechanism or electromagnets. Cable handles and selector switches are mounted under the instrument panel.



Figure 93. Bomb/Tank selector switches



Figure 94. External fuel tanks release handles

Tanks can be released alternately or simultaneously.

Dives

Trim the plane slightly tail heavy so that you need a little stick pressure to hold the plane in the dive. Have cowl flaps closed for a dive. Decrease manifold pressure to keep it from over boosting the engine.

Start dives in a P-47 from level flight by pushing the nose down. Do not start a dive from a Split-S.

Do not retard the throttle suddenly in a high-speed dive. The nose becomes heavy and the dive steepens. The dive speed will increase.

Recover gradually from a high-speed dive. A sharp pullout places unnecessary loads on the wings and control surfaces.

Never dive with cowl flaps OPEN.

The P-47D-30 is also equipped with compressibility recovery flaps that can be used to pull-out from high-speed dives.

Landing

Before entering the landing pattern, make sure that you have enough fuel to land and select the needed fuel tank by rotating the fuel selector valve.

Set mixture control to AUTO RICH.

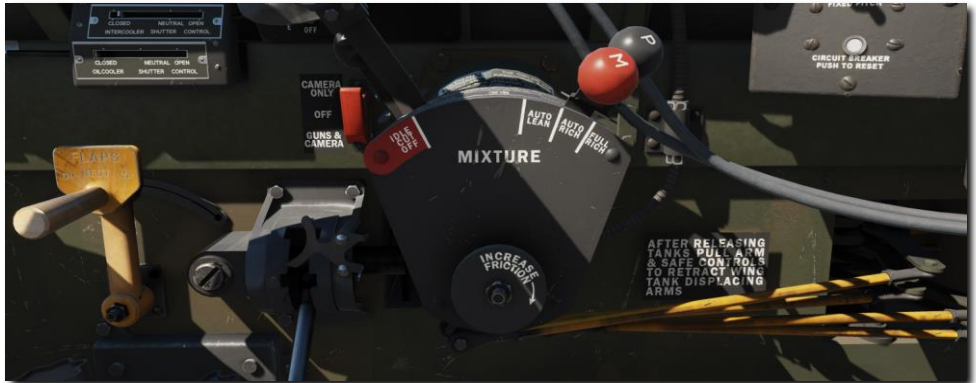

Propeller mode switch should be set to AUTO CONSTANT SPEED.



Interconnect throttle and turbosupercharger lever by connecting latch. Set engine RPM to 2550.

Close the cowl flaps.

Approach airfield at 1500ft and 200 mph.



After passing the reverse end of the runway, make a 180-degree turn.

Reduce speed to 160mph.

Lower the landing gear and check the gear warning lights. Ensure that the hydraulic system pressure is restored to (approximately) 1000 PSI. Trim the plane by using elevators trim.



Reduce altitude to 600-800ft.

NOTE! Do not lower the landing gear and flaps at speeds in excess of 190 mph.



Note. Landing gear warning light goes out when gear are fully down and locked.

Lock the tailwheel.



Lower the flaps when turning on final approach and the airspeed is below 160 mph IAS and reduce altitude to 500ft.



Maintain approximately 150 mph IAS in the traffic pattern.

Once lined up on final with the flaps lowered, maintain approximately 115-120 mph IAS.



When you are sure of a correct landing approach, cut the throttle.

Just before getting to the runway, break the glide with a controlled flare and approach so as to land within the first third of the runway in a 3-point attitude.

Hold the aircraft in the 3-point attitude just above the runway until flying speed is lost and the plane sets down at approximately 90 mph.

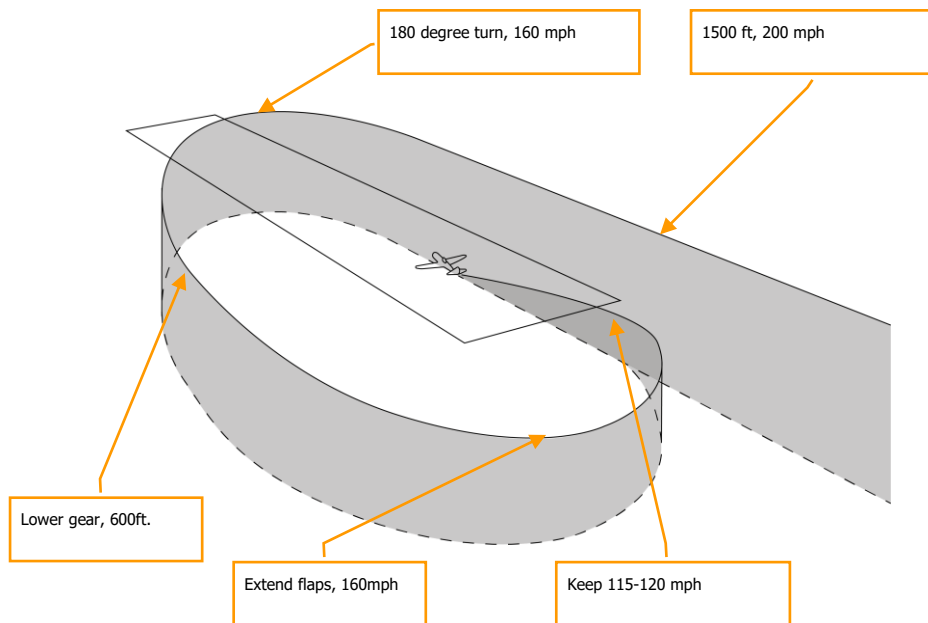

Figure 95. Thunderbolt's landing pattern

Use a landing light when landing at night. The maximum flight speed when landing light can be extended is 200 mph.

Stopping engine

1. Apply toe brakes and set the parking brake.
2. Set engine to 1000 RPM and place mixture control in "IDLE CUT-OFF," holding the dilution switch "ON", until the engine stops.
3. After the propeller stops rotating, turn ignition switch to "OFF".
4. Set fuel selector valve to "OFF".
5. Set all switches at main switch box to "OFF".

The aircraft has an oil dilution system that uses an electromagnetic valve, controlled by an oil dilution switch to make it easier to start an aircraft in a cold-weather conditions. Gasoline enters the engine oil system through an open valve, reducing oil viscosity. Gasoline gradually evaporates from the crankcase through the ventilation system.

EMERGENCY PROCEDURES



EMERGENCY PROCEDURES

Engine Emergencies

Engine overheating

An engine overheating in flight is likely caused by one of the following:

- You have been climbing at high power and below recommended airspeed. In other words, the air blast in the air scoop is insufficient. To remedy this problem, level out, reduce power and increase airspeed.
- The oil supply is depleted. This situation may be discovered by reading the oil pressure gauge. The engine will continue to overheat even after the shutters are opened all the way. There is no fix for this problem, so maintain the RPM and power as low as possible and land as soon as possible.

If conditions are favorable for a dead-stick landing and overheating persists, consider the possibility of shutting down the engine prior to landing.

Engine failure

Engine failures fall into two main categories: those occurring instantly and those giving ample warnings. The instant failure is rare and usually occurs only if ignition or fuel flow completely fails. Most engine failures are gradual and afford the alert pilot ample indication that a failure may be approaching. An extremely rough-running engine, loss of oil pressure, excessive coolant temperature under normal flight conditions, loss of manifold pressure, and fluctuating RPM are indications that a failure may occur. When indications point to an engine failure, the pilot should land immediately.

Engine air restart

If the engine fails in flight and you have sufficient altitude, you may attempt a restart, provided the engine did not fail for obvious mechanical reasons. Unless the engine seizes or internal structural failure occurs, the propeller will windmill even at minimum glide speed. Should airspeed inadvertently drop to a value where the propeller ceases to rotate, the aircraft should be nosed down to regain additional speed. In nearly all cases, the propeller will start to rotate again. If necessary, the starter may be used to turn the engine over. All unnecessary electrical equipment should be turned off before the starter is used. Use starting procedure after checking fuel tank selector handle on fullest tank.

Engine Failure in the Takeoff Run

The chances of engine failure during takeoff can be greatly reduced if the engine is run up carefully and checked thoroughly beforehand. If engine failure occurs during the takeoff run before the aircraft leaves the ground, proceed as follows:

- Close throttle completely.
- Apply brakes as necessary to affect a quick stop.
- If doubt exists as to whether the aircraft can be brought to a safe stop on runway, ignition switch should be set to OFF and fuel shutoff valve lever to OFF.
- If insufficient runway remains for a safe stop or obstacles cannot be avoided, jettison external load and move landing gear handle UP.
- Roll canopy back or pull canopy emergency release handle.

Engine failure after takeoff

If an engine failure occurs soon after takeoff, the pilot has to think fast and take the correct course of action before too much speed is lost and not enough safe ground is available for a landing. Perform the following steps:

- Move Mixture control to FULL RICH if the engine begins to fail.
- If failure persists, immediately lower the nose to maintain airspeed.
- Release external bombs or tanks, if loaded.
- Release the canopy by pulling the Canopy Emergency Release handle.
- If a safe landing is in doubt, move the landing gear handle to UP and land on belly.
- If time permits, lower the flaps.
- Move mixture control to IDLE CUTOFF.
- Turn ignition switch OFF.
- Move fuel shutoff valves to OFF.
- Turn the battery switch to OFF.
- Land straight ahead.
- After landing, get out and stay out.

Engine failure in flight

If the engine fails during flight, lower the nose immediately so that airspeed does not drop below stall speed. Keep IAS well above stall speed. Set fuel booster pump rheostat to Fuel Booster Pump position and wait until RPM is restored. If no, prepare to land.

- Set ignition switch to OFF.
- Jettison the canopy.
- Release bombs/tanks if loaded.
- Set mixture control handle to IDLE-CUTOFF.
- Set fuel selector valves to OFF.
- Lower flaps (Full).

Set the battery disconnect switch to OFF, unless electrical power is desired for operating the lights or radio.

Choose an area for landing. If near a landing field, notify the tower. Judge turns carefully and plan to land into the wind.

- If a long runway is available and time and altitude are sufficient to properly plan an approach, set the landing gear handle to DN. If landing under any other condition, keep the gear up.
- Land into the wind.
- After landing, get out and stay out.

Turbo collapse

A turbo collapse is the phenomenon of a turbo-charging crisis that occurs in a running turbosupercharger when a pilot begins to reduce engine power by pulling throttle back. At the same time, the pressure and consumption of exhaust gases that rotate the turbine decreases, and at the moment when their quantity becomes insufficient to maintain a given boost, there is an even greater drop in engine power, which provokes a progressive pressure drop in the inlet manifold.

It is necessary to push stick forward into dive and move throttle forward in order to restore the cylinder filling and exhaust gas pressure to restore normal supercharging after the collapse.

Supercharging recovery after a turbo collapse can take up to 30 seconds at high altitudes.

Fire

In the event of a fire, keep the canopy entirely closed. Opening the canopy will result in it quickly filling with smoke. Similarly, do not lower the landing gear as this may also blast the fire into the cockpit.

If an engine fire develops, attempt to control the fire by performing the following steps:

- Mixture control set to IDLE CUTOFF.
- Fuel shutoff valves set to OFF.
- Throttle CLOSED.
- Ignition switch to OFF.
- Battery disconnect switch to OFF, unless power is desired to operate the radio or lights.

While remaining in the cockpit during a fire, cover all the exposed parts of your body, including your eyes. If the fire situation requires bailing out, only open the canopy when you are ready to leave the aircraft. Don't release the canopy until after you have unlocked the safety harness, trimmed the aircraft, and are crouched with your feet in the seat ready to spring out. Then pull the canopy emergency release handle and lunge upward to the right, pushing the canopy off with the head.

Landing Emergencies

Forced Landing Over Doubtful Terrain

If a forced landing over doubtful terrain is unavoidable, don't hesitate to attempt a belly landing. Forced landing with wheels down should be made only when absolutely certain that such a procedure is safe.

Belly landing

When a belly landing is unavoidable, it's best to perform the landing on a hard surface. On soft or loose ground, the air scoop tends to dig in, not only stopping the aircraft suddenly, but also causing more damage to the airframe than a hard-surface belly landing.

Belly landing procedure

- Keep the wheels up.
- Jettison any tanks and bombs.
- Lower the seat, duck your head, and jettison the canopy.
- Make sure your shoulder harness and safety belt are locked.
- Lower the flaps fully once sure of the landing area.
- Maintain a speed of about 140-150 mph until contact is achieved.
- Approach in a 3-point attitude to slow the aircraft.
- Cut the switches just before impact.
- As soon as the aircraft stops, get out and move to a safe distance as quickly as possible.
- Unless assistance is available nearby, stay close to the aircraft to assist a searching party in locating your position. Consider using oil or gasoline to start a signal fire if conditions allow.

Forced landing at night

If a forced landing is necessary at night, it is recommended to bail out unless visibility conditions are exceptionally good. Don't attempt a night-time forced landing – even a belly landing – unless there is radio contact with a ground controller, you are in direct vicinity of a known airfield, and are sure the aircraft is in a sufficient condition for a safe landing.

Brake failure

Remember that the brake system is not operated by the hydraulic system of the aircraft and that each brake is operated by its own individual pressure cylinder, which is activated by using the brake pedals. It is extremely unlikely, therefore, that both brakes will fail at the same time. When one brake fails, it is almost always possible to use the other in stopping the aircraft.

If one brake goes out while taxiing, use the other (good) brake and also the lockable tail wheel. Immediately chop the throttle and cut the switch. If you're going too fast to stop the aircraft in this matter, lock the good brake, and ground loop until the aircraft stops.

If, when coming in for a landing, you know that your brakes are inoperative – or even if you suspect such a condition – approach the field and land as slow as safety permits. Use full flaps and use your best technique in making a 3-point landing. Stop the engine completely by cutting the mixture control as soon as your plane is on the ground. The dead prop creates additional braking action to help make your landing as short as possible.

If the brakes are locked, never attempt a wheel-type (tail high) landing. If you do, you will either hit the prop or nose over altogether.

Hydraulic system failure

In the event of a hydraulic failure, if the landing gear does not release, do not try to increase the pressure in the hydraulic system using the hydraulic pump handle. Remaining pressure in the hydraulic system is needed to release the flaps.

Put the landing gear control handle in the DOWN position. This releases the mechanical locks which hold the gear in place. Use the control stick to rock the plane from side to side, make turns and/or dives until the landing gear is fully extended.

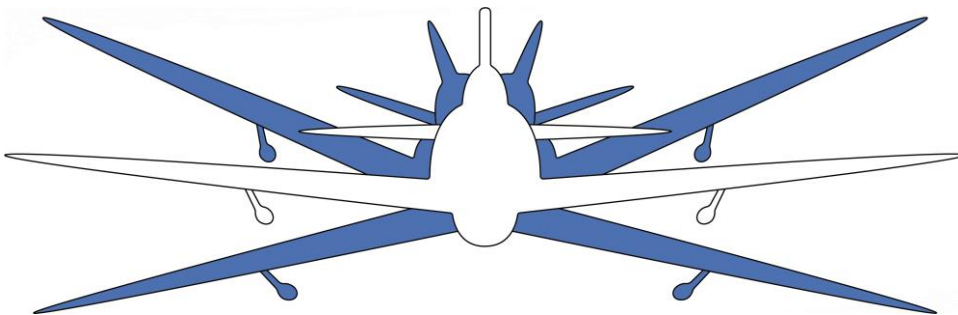

Figure 96. Rock It to lock It

Before using an emergency hydraulic pump to release flaps, set the landing gear handle to NEUTRAL position. If not, the remaining pressure in the hydraulic system will disperse throughout the landing gears control system.

After releasing the flaps, return the flaps control lever to neutral position. Then set the landing gear handle to DOWN position. Use emergency hydraulic pump to increase the pressure in the hydraulic system.

Tail wheel has no mechanical lock. The pressure created in the hydraulic system by the hydraulic pump lever reduces the risk of wheel damage.

After landing, no steering is allowed, as it may cause the wheel retraction.

Tire Failure

If a tire is low or blown out during a landing approach, perform a 3-point landing. Don't use the brakes until necessary, then use the opposite brake, but only slightly, and enough opposite rudder to keep the aircraft straight.

Land on the left side of the runway if the right tire is flat and on the right side if the left tire is flat.

If a tire is completely lost, do not attempt to land on a rim. Perform a belly landing.

Ditching

Never attempt to ditch a P-47D except as a last resort. Fighter aircrafts are not designed to float on water, and the P-47D has an even greater tendency to dive because of shape of the nose section. It will go down in a second.

If a problem arises over water and if reaching land is impossible, bailing out is preferred to ditching. In most situations, it should be possible to pull up to at least 500 feet to make a safe jump. In such a case, perform as steep of a climb as possible to exit the aircraft at the highest possible altitude. When bailing out, it is recommended to use the right side of the aircraft due to the slipstream helping to clear the tail section safely.

Bailing Out

There are several methods of bailing out of the P-47D, when the aircraft is under control. However, the following bailout procedure is recommended, because it remains essentially the same whether the aircraft is under control, on fire, or in a spin.

Slow the aircraft to the lowest speed that is reasonably safe – usually about 150 mph. The lower the speed during a bailout, the less risky it is. Avoid slowing down to a stall, particularly if there is no power.

Lower the seat, duck your head, and jettison the canopy.

Disconnect the headset and oxygen hose, and release the safety belt and shoulder harness.

Pull yourself up onto the seat so that you are in a crouching position with your feet on the seat.

Dive with head down toward the trailing edge of the right wing, unless a fire or some other condition makes it advisable to go out the left side.

Bailout at High Altitude

If a problem occurs at high altitude, attempt to reduce altitude before bailing out. If reducing altitude is not possible, open the emergency knob on the oxygen regulator and fill your lungs with oxygen by taking several full breaths. Hold your breath as long as possible during free fall to reduce problems associated with cold rarified air at high altitudes. Also, when bailing out at high altitude, it is recommended to extend the free fall until lower altitudes are reached, as opening the chute at higher altitudes induces greater G loads on the body.

Bailout in a Spin

When bailing out during a spin, it is recommended to jump on the side inside the spin, as opposed to the outside. This helps avoid hitting the airframe during the jump.

Bailout over Water

When bailing out over water, it's critical to follow a definite radio procedure in order to maximize the chances of a quick rescue. If possible, gain altitude in order to increase the range of the VHF radio and help Air/Sea Rescue unit attain a fix of your location. General steps for a radio procedure are as follows:

- Notify wingmen of your status.
- If equipped with an IFF set, turn the emergency switch to ON.
- Transmit "Mayday" three times, followed by the call sign of your aircraft three times.
- Your first transmission will be on the assigned air-ground frequency. If communication cannot be established on this frequency, use any other available frequency to establish contact with a ground station.
- If time permits, provide the following information:
 - Estimated position and time.
 - Course and speed.
 - Altitude.
- Intent as to bail out or ditch.

In case the situation normalizes and bailing out is no longer necessary, be sure to cancel the distress call on the same frequency.

COMBAT EMPLOYMENT



COMBAT EMPLOYMENT

In this section, we will overview weapon employment procedures for the P-47D.

Guns

Eight Browning M2 .50 caliber machine guns are available, four in each wing, with a maximum load of 425 rounds per gun with a one-second salvo weight of 5.8 kilograms. It's a one of the highest performances for fighters of those years. This provides about 30 seconds of continuous firing or about 15 two second bursts. After fuel, ammunition is your most important consumable item on the aircraft so you will want to use it sparingly.

Aiming is performed with the K-14 gunsight, which displays the required angle off for enemy aircraft engagement, depending on the distance to the aircraft.

To fire guns

1. Set Gun Safety Switch to GUNS & CAMERA position
2. Set desired brilliance of the gunsight by rotating gunsight brilliance rheostat
3. Pull the trigger on the control stick.

Aiming with the K-14 Gunsight

The K-14 gunsight contains two aiming sights: the compensating (gyro) sight and the fixed sight. In the fixed sight, a crosshair represents the aiming pipper. The two sights cannot be used selectively. Using both sights simultaneously can provide a helpful indication of the amount of lead the gyro sight is generating from the boresight position. In this case, it's best to mask the fixed sight ring in order to declutter the aiming line of sight.



Figure 97. K-14 sight reticles

The fixed sights consist of the crosshairs and a 70-mil ring (when unmasked).

The gyro sight consists of a dot surrounded by six diamonds. Using the gyro sight, aiming is accomplished by maneuvering the aircraft to position the dot directly over the target and keeping the enemy aircraft surrounded by the six diamonds until the kill is made.

The front of the sight panel includes a span scale, calibrated from 30 to 120 feet. The scale is set to match the expected enemy aircraft wingspan prior to the start of an engagement.

K-14 sight includes range dial, which is graduated from 600 to 2400 feet.



Figure 98. Range dial

As the dial rotates, the circular scale moves, showing the setting of the target range.

As the aircraft is maneuvered to place and keep the dot on the enemy, the range dial is turned to continually adjust the size of the reticle of diamonds so that the target is surrounded by the inner points of the diamonds. The dot must be kept on target for a duration of one second before firing to give the sight time to calculate the correct lead angle.

An imaginary circle should be visualized to connect the inner points of the diamonds to create a continuous aiming reticle.

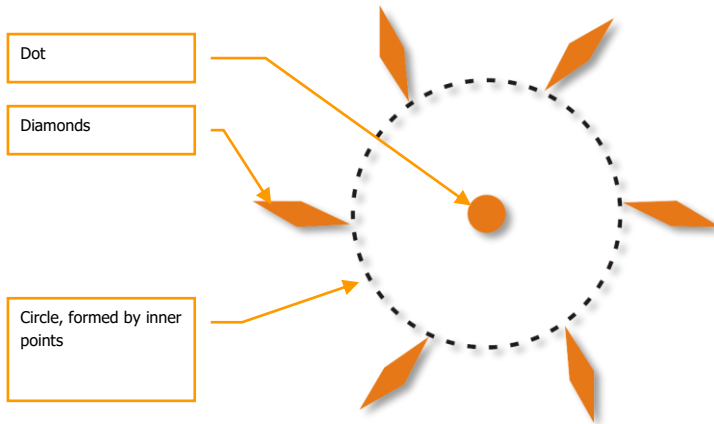

Figure 99. Gyro sight

When preparing for an engagement, the range dial should be set to the minimum range of 600 feet. The same should be done when switching from one target to another.

When beginning to aim at a target, the range should be maintained at the minimum setting until the dot is at or near the target. Then the range dial is used to set the correct range by framing the target inside the diamond circle. This procedure reduces over-ranging, prevents over-correction, and most quickly achieves a firing solution.

When the target aircraft is at right angles - a 90° deflection shot - the wings cannot be used to set the sight frame, even if the target is banking. On most aircraft, the distance from the cockpit to the extreme end of the tail is approximately half of the wingspan. Therefore, correct aim can be achieved by placing the dot on the cockpit with the imaginary circle touching the tail.

Note that the circle is on the extreme end of the tail, not just the assembly.

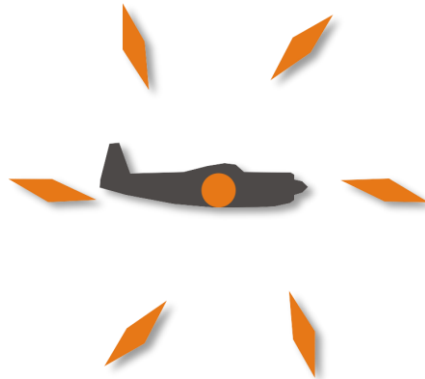

Figure 100. Target 90 degree

If neither the wings nor the fuselage is at right angles, the frame must be made slightly larger than the aircraft to compensate for the viewing angle. If wings and fuselage are at 45° , an additional $1/6$ of the diameter should be added, or $1/3$ of the radius, on each side of the target, ranging on the tip of the wings and the tip of the tail. This is the maximum allowance. One-tenth of the diameter of the reticle serves for most purposes.



Figure 101. Target's Wings and Fuselage are at 45°

When the separation of the fixed cross and the dot shows that a long lead, around 85 to 100 mils, is being allowed, any small ranging error is magnified by distance and makes long range firing

unprofitable. When only a short lead is indicated, small ranging errors are unimportant. Fire is effective at maximum range.

When closing in on a target at ranges of less than 600 feet, the diamonds can be ignored altogether. Effective fire can be made by simply keeping the dot on target.

Both the gyro and fixed sights are seen on a reflector plate. They are focused to infinity by means of collimator lenses. Parallax effects have been reduced to a minimum, which prevents a shifting of the target in relation to the reticle when moving the pilot's line of sight through the gunsight.

The illustration below demonstrates correct and incorrect aiming solutions for a number of likely engagement scenarios.

Target patterns. Correct and wrong



Correct – You have exact range now. Fire!



Incorrect – Dot is not on target

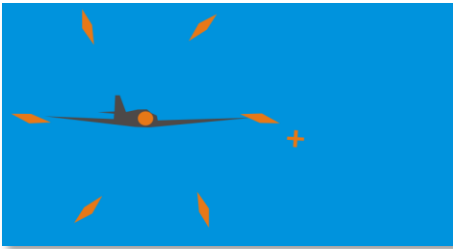

Correct – Circle of diamonds corresponds to target's wingspan.

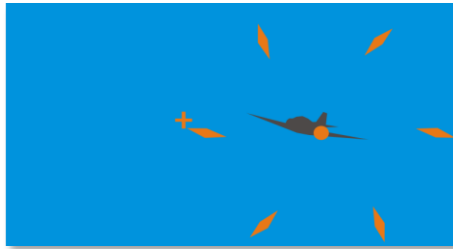

Incorrect – Circle of diamonds is too large, making range and lead angle wrong



Correct – On broadside attacks the circle should be a trifle larger than length of fuselage, as wingspan is greater than length

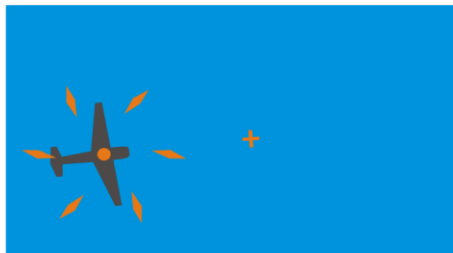

Incorrect – Imaginary circle formed by inner tips of diamonds should correspond to target's wingspan

K-14 preflight check

Before takeoff, check the sight as follows:

- Gun Safety switch set to GUNS & CAMERA.
- Set reticle mask switch to desired position.
- Rotate sight dimmer rheostat to obtain desired brilliance. Both reticle images should appear on the reflector glass.
- Pick a point on the horizon; make sure gyro reticle image dot is superimposed on fixed-reticle cross.
- Rotate range dial on gunsight to check operation of gyro reticle image circle from minimum to maximum range.

Firing guns with K-14 gunsight

Normal flight operation of the sight is accomplished as follows:

- Gun Safety switch set to GUNS & CAMERA.
- Identify target; then set span adjustment lever to correspond with span of target aircraft.
- Fly the aircraft so that the target appears within the gyro reticle circle and rotate the range dial until the diameter of the gyro reticle circle corresponds to the target size.
- Continue to frame the target with the gyro reticle circle by rotating the twist grip as range changes. Track the target smoothly for one second; then fire.
- Continue ranging and tracking while firing.

Bombs

Releasing bombs

The following is a standard procedure for releasing bombs:

- Set the Bomb selector switches to the up position.
- Press the Bomb-Rocket Release button on the control stick grip momentarily to release selected bombs.



Figure 102. Release button and bomb selector switches

Note, bombs may be released when the aircraft is in any pitch attitude from a 30-degree climb to a vertical dive.

Do not release bombs when you are side slipping more than 5 degrees in a vertical dive. Doing so may collide a bomb and the propeller.

RADIO COMMUNICATIONS



RADIO COMMUNICATIONS

There are two optional modes of using the radio that depend on the "EASY COMMUNICATION" OPTION under the GAMEPLAY tab. This setting also determines the key commands used to access the radio menu in-game.

Because the SCR-522A VHF AM radio of the P-47D is limited to 5 channels, you will only be able to communicate with those entities whose frequencies are loaded in your radio. Radio frequencies are loaded in the mission editor by the mission designer and should be made available as part of the mission briefing.

Easy Communication is enabled

The radio communications window is accessed by a press of the **[\]** backslash key (this is for US keyboards; other language keyboards may vary). After the command selection the radio or interphone will be selected (if required) and tuned (if required) automatically. Also **[\]** key will close radio command menu.

When the radio menu is displayed, recipients are color-coded as follows:

- Recipients on which at least one of the radios is tuned to are colored white.
- Recipients on which at least one of the radios can be tuned to but is not currently on the correct frequency are colored gray.
- Recipients that cannot be contacted due to range or terrain masking / earth curvature are colored black.

Each will also have their modulation / frequency listed. When you select a recipient, the appropriate radio will automatically be tuned to communicate with the selected recipient.

When Easy Communications mode is enabled, the following 'quick' command shortcuts are also available:

[LWIN + U] Request AWACS vector to home plate.

[LWIN + G] Command flight to attack ground targets.

[LWIN + D] Command flight to attack air defense targets.

[LWIN + W] Command flight to cover me.

[LWIN + E] Command flight to proceed with the mission and return to base.

[LWIN + R] Command flight to proceed with the mission and rejoin.

[LWIN + T] Command flight to open/close the formation.

[LWIN + Y] Command flight to rejoin the formation.

Easy Communication is not enabled

When Easy Communications mode is OFF, the Push To Transmit (PTT) button [RALT + \] is used to open the radio command panel. The PTT button opens and closes the radio communications window for the currently selected radio.

When recipients are displayed, there is no color-coding of availability and no listing of their modulation / frequency. This is the more realistic play mode and requires you to know the correct modulation / frequencies for each recipient and you must manually enter the frequencies on the correct radio.

Radio Communications Window

Top Level Recipient List:

If using "Easy Communications", recipients not present in the mission will not be listed.

F1. Wingman...

F2. Flight...

F3. Second Element...

F4. JTAC...

F5. ATCs...

F7. AWACs...

F8. Ground Crew...

F10. Other...

F12. Exit

Hotkeys will also be available to directly issue any command in the structure. These can be found in Input Options.

To exit radio communications, you can also press the ESC key.

F1 Wingman

Upon selecting F1 Wingman from the main radio communications window, you have the option to select the basic type of message you wish to send to your number 2 wingman. These are:

F1. Navigation...

F2. Engage...

F3. Engage with...

F4. Maneuvers...

F5. Rejoin Formation

F11. Previous Menu

F12. Exit

F1 Navigation...

The Navigation options allow you to direct where your wingman will fly to.

F1. Anchor Here. Your wingman will orbit at its current location until you issue a Rejoin command.

F2. Return to base. Your wingman will return to and land at the airbase designated in the flight plan.

F11. Previous Menu

F12. Exit

F2 Engage...

The Engage options allow you to direct your wingman to attack a specific type of target. After issuing the order, the wingman will attempt to locate the specified target type and attack it.

F1. Engage Ground Targets. Wingman will attack any enemy ground unit it can locate.

F2. Engage Armor. Wingman will attack any tanks, infantry fighting vehicles, and armored personnel carriers it can locate.

F3. Engage Artillery. Wingman will attack any tube artillery or multiple rocket launchers that it can locate.

F4. Engage Air Defenses. Wingman will attack any enemy anti-aircraft artillery and surface to air missile units that it can locate.

F5. Engage Utility Vehicles. Wingman will attack all supply, transport, fuel, power generation, command and control, and engineering units it can locate.

F6. Engage Infantry. Wingman will attack hostile infantry units. Note that the infantry units are very difficult to detect unless they are moving or firing weapons.

F7. Engage Ships. Wingman will engage enemy surface combatants. Note that most surface combatants are heavily armed and that the P-47D is not well-suited to attacking such targets.

F8. Engage Bandits. Wingman will engage any enemy fixed-wing and rotary-wing aircraft it can locate.

F11. Previous Menu

F12. Exit

F3 Engage With...

Whereas the F2 Engage command allows you to give basic orders for your wingman to attack a target type, the F3 Engage With set of commands not only allows you to determine target type, but also the direction of attack and what weapon type to use. This is done in a tiered manner by first selecting target type, then weapon type, and finally the attack heading. The wingman will then attempt to locate targets of the specified type and attack them according to your specified weapon and attacking heading. While the F2 Engage options are fast to issue, the F3 Engage With options provide much greater control.

Target Type. These options mirror those of the F2 Engage orders and allow you to determine the type of ground target you want your wingman to engage.

F1. Engage Ground Targets. Wingman will attack any enemy ground unit it can locate.

F2. Engage Armor. Wingman will attack any tanks, infantry fighting vehicles, and armored personnel carriers it can locate.

F3. Engage Artillery. Wingman will attack any tube artillery or multiple rocket launchers that it can locate.

F4. Engage Air Defenses. Wingman will attack enemy anti-aircraft artillery and surface to air missile units that it can locate.

F5. Engage Utility Vehicles. Wingman will attack all supply, transport, fuel, power generation, command and control, and engineering units it can locate.

F6. Engage Infantry. Wingman will attack hostile infantry units. Note that the infantry units are very difficult to detect unless they are moving or firing weapons.

F7. Engage Ships. Wingman will engage enemy surface combatants. Note that most surface combatants are heavily armed and that the P-47D is not well-suited to attacking such targets.

Weapon Type. Once you have selected the target type, you will be given a list of weapon types that you want your wingman to engage the target with. These include:

F2. Unguided Bomb...

F4. Rocket...

F6. Gun...

Attack Heading. After you've selected the weapon type for your wingman to use, the third and final step is to determine the attack heading that you wish your wingman to use. This can be useful to help it avoid overflying enemy defenses. The options include:

F1. Default. Wingman will use the most direct heading to attack the target.

F2. North. Wingman will attack the target from south to north.

F3. South. Wingman will attack the target from north to south.

F4. East. Wingman will attack the target from west to east.

F5. West. Wingman will attack the target from east to west.

F4 Maneuvers...

Although your wingman will generally do a good job of knowing when and how to maneuver, there may be times when you want to give him/her a very specific maneuvering order. This could be in response to a threat or to better set up an attack.

F1. Break Right. This command will order your wingman to make a maximum-G break to the right.

F2. Break Left. This command will order your wingman to make a maximum-G break to the left.

F3. Break High. This command will order your wingman to make a maximum-G break high.

F4. Break Low. This command will order your wingman to make a maximum-G break low.

F7. Clear Right. Your wingman will perform a 360-degree turn to the right of the current flight path while searching for targets.

F8. Clear Left. Your wingman will perform a 360-degree turn to the left of the current flight path while searching for targets.

F9. Pump. Your wingman will perform a 180-degree turn from its current heading and fly 10 nm. Once reached, it will turn 180-degrees back to the original heading.

F5 Rejoin Formation

Issuing this command will instruct your wingman to cease its current task and rejoin formation with you.

F2 Flight

Upon selecting F2 Flight from the main radio communications window, you have the option to select the basic type of message you wish to send. These are:

F1. Navigation...

F2. Engage...

F3. Engage with...

F4. Maneuvers...

F5. Formation

F6. Rejoin Formation

F11. Previous Menu

F12. Exit

F1 Navigation...

The Navigation options allow you to direct your flight where to fly to.

F1. Anchor Here

F2. Return to base

F11. Previous Menu

F12. Exit

These commands mirror those of the Wingman Navigation commands, but apply to all flight members.

F2 Engage...

The Engage options allow you to direct your flight to attack a specific type of target. After issuing the order, the flight will attempt to locate the specified target type and attack it.

F1. Engage Ground Target

F2. Engage Armor

F3. Engage Artillery

F4. Engage Air Defenses

F5. Engage Utility Vehicles

F6. Engage Infantry

F7. Engage Ships

F8. Engage Bandits

F11. Previous Menu

F12. Exit

These commands mirror those of the Wingman Navigation commands, but apply to all flight members.

F3 Engage With...

These commands mirror those of the Wingman Engage With commands, but apply to all flight members. These commands work the same as the Wingman Engage With Commands described above.

F4 Maneuvers...

F1. Break Right

F2. Break Left

F3. Break High

F4. Break Low

F7. Clear Right

F8. Clear Left

F9. Pump

F11. Previous Menu

F12. Exit

These commands mirror those of the Wingman Maneuvers commands, but apply to all flight members.

F5 Formation

From the Formation menu, you can select the formation that the flight will fly in relation to you as the flight leader.

F1. Go Line Abreast

F2. Go Trail

F3. Go Wedge

F4. Go Echelon Right

F5. Go Echelon Left

F6. Go Finger Four

F7. Go Spread Four

F8. Open Formation

F9. Close Formation

F11. Previous Menu

F12. Exit

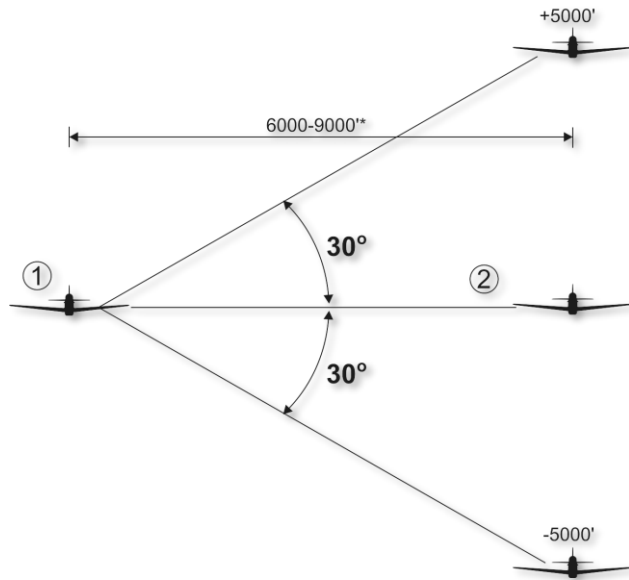
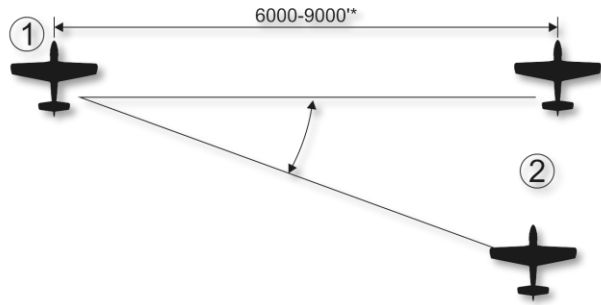

Figure 103. F1 Go Line Abreast



Figure 104. F2 Go Trail

Position may be modified within a 4000-12,000' envelope by flight lead.

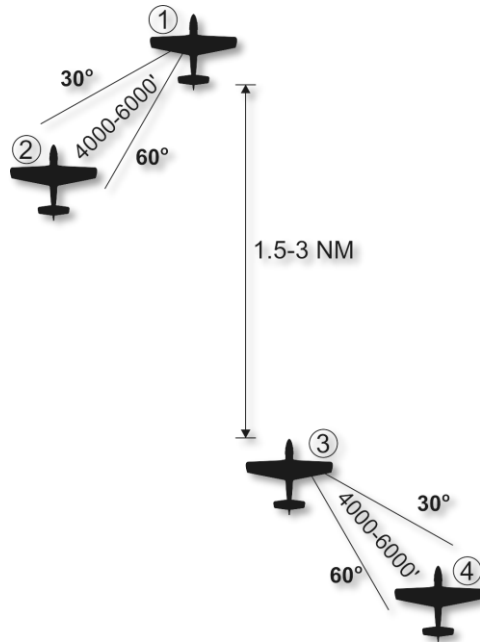

Figure 105. F3 Go Wedge

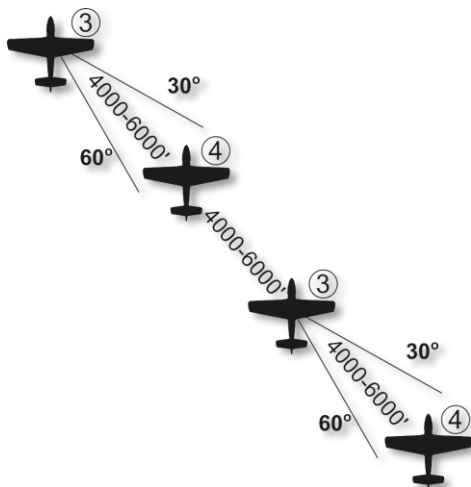

Figure 106. F4 Go Echelon Right

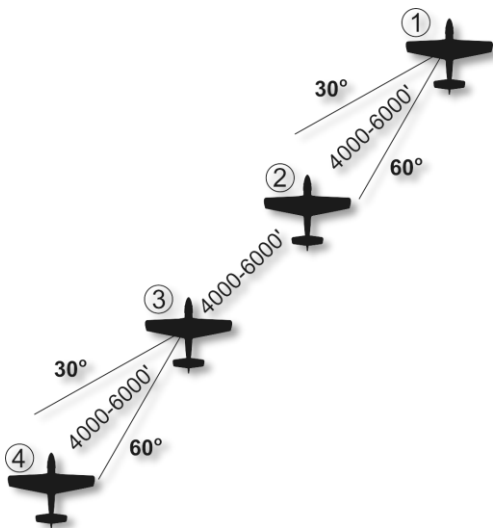

Figure 107. F5 Go Echelon Left

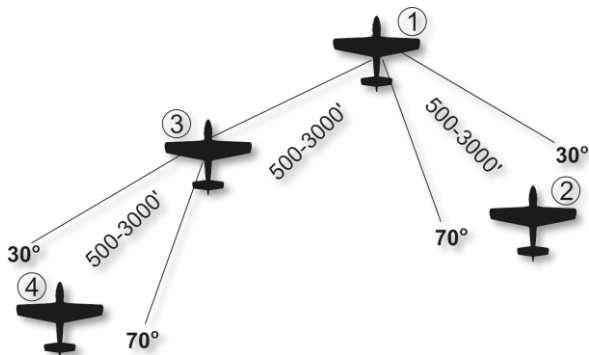

Figure 108. F6 Go Finger Four

Position may be modified within a 4000-12,000' envelope by flight lead.



Figure 109. F7 Go Spread Four

Position may be modified within a 4000-12,000' envelope by flight lead.

F8. Open Formation. Increase the distance between each aircraft in the current formation.

F9. Close Formation. Decrease the distance between each aircraft in the current formation.

F6 Rejoin Formation

Issuing this command will instruct your flight to cease their current task and rejoin formation with you.

F3 Second Element

Upon selecting F3 Second Element from the main radio communications window, you have the option to select the basic type of message you wish to send to the second element of your flight. The second element consists of flight members 3 and 4 with number 3 being the element lead. When issuing a command to second element, number 3 and 4 carry out the order jointly. These commands are:

F1. Navigation...

F2. Engage...

F3. Engage with...

F4. Maneuvers...

F5. Rejoin Formation

F6. Out

F11. Previous Menu

F12. Exit

F1 Navigation...

The Navigation options allow you to direct your second element where to fly to.

F1. Anchor Here

F2. Return to base

F11. Previous Menu

F12. Exit

These commands mirror those of the Wingman Navigation commands, but apply to the second element.

F2 Engage...

The Engage options allow you to direct your second element to attack a specific type of target. After issuing the order, the wingman will attempt to locate the specified target type and attack it.

F1. Engage Ground Target

F2. Engage Armor

F3. Engage Artillery

F4. Engage Air Defenses

F5. Engage Utility Vehicles

F6. Engage Infantry

F7. Engage Ships

F8. Engage Bandits

F11. Previous Menu

F12. Exit

These commands mirror those of the Wingman Maneuvers commands, but apply to the second element.

F3 Engage with...

These commands mirror those of the Wingman Maneuvers commands, but apply to the second element.

F4 Maneuvers...

Although your second element will generally do a good job of knowing when and how to maneuver, there may be times when you want to give him/her a very specific maneuvering order. This could be in response to a threat like an incoming SAM, or to better set up an attack.

F1. Break Right

F2. Break Left

F3. Break High**F4. Break Low****F7. Clear Right****F8. Clear Left****F9. Pump****F11. Previous Menu****F12. Exit**

These commands mirror those of the Wingman Maneuvers commands, but apply to the second element.

F5 Rejoin Formation

Issuing this command will instruct your second element to cease its current task and rejoin formation with you.

Flight Member Responses

After sending a radio message to any of your flight members, you will have one of two responses:

Flight number of responder (2, 3, or 4). When a flight member will carry out the order, it will respond simply with its flight number.

(Flight member number) unable. When a flight member cannot carry out the order, it will respond with its flight number following by "unable". For example: "2, unable"

F4 JTAC

Depending on the battlefield situation, the level of JTAC control of the attack may vary. There are three types of terminal attack control:

Type 1: JTACs use Type 1 control when the risk assessment requires them to visually acquire the attacking aircraft and the target under attack. This is the most common and restrictive of the three types. Type 1 is most often used when friendly forces are "danger close".

Type 2: Type 2 control will be used when the JTAC desires control of individual attacks but assesses that either visual acquisition of the attacking aircraft or target at weapons release is not possible or when attacking aircraft are not in a position to acquire the mark/target prior to weapons release/launch.

Type 3: Type 3 control may be used when the tactical risk assessment indicates that CAS attack imposes low risk of fratricide. This is the least restricted control type.

In order to communicate with a JTAC, there must be at least one in the mission. Any unit can be assigned as a JTAC. JTACs are assigned a radio frequency that they need to be contacted on. For P-47D this must be VHF AM radio.

JTAC Engagement Flow

To contact a JTAC, open the main radio menu ([**V**] or [**RALT + V**]). Press F4 to select JTACs from the Radio Main Menu.

After selecting "JTACs", a list of JTACs in the mission will be displayed, along with their frequencies and callsigns (if using Easy Communications). Select the JTAC that you wish to contact. If you are using realistic radio, you will need to ensure that the correct radio is tuned to the correct frequency that the JTAC is on (most often listed in Mission Briefing). If using Easy Communications, the correct radio and frequency will be set automatically. You will then be prompted to Check-in with the estimated time you will be available for tasking (Play Time).

When you check-in, you will automatically radio the JTAC key information that includes:

- Your mission number
- Location from Initial Point (IP) and your altitude
- What you are armed with
- How long you are available (hours + minutes)

You will then automatically ask what tasking the JTAC has for you.

After a pause, the JTAC will reply with the terminal control type (1, 2 or 3) that will be used and then ask if you are available for the 9-line. The 9-line is a standard briefing form that provides the pilot key information to prosecute the attack. When you are ready, press the [**V**] or [**RALT + V**] key to view the radio menu and then press F1 "Ready to copy".

The JTAC will now read the 9-line as follows:

1. The Initial Point (IP) that the attack should be started from. This is a point created in the Mission Editor.
2. Attack heading to the target and any offset needed
3. Distance to target
4. Elevation of target (MSL)
5. Target type

6. UTM coordinates of target
7. How the target is marked (None, White Phosphorus (WP), or IR Pointer)
8. Location of nearby friendly ground forces
9. Control point to egress to

After completing the 9-line, the JTAC will automatically ask if you are ready for remarks. Remarks are additional information not included in the 9-line. When ready, press **[N]** or **[RALT + N]** and then **[F1]**. The JTAC will then radio the remarks, which generally include the weapon to use, weather information, and/or attack headings.

You will now need to read back the target location and elevation, and other data if applicable such as final attack heading. To do so, press **[N]** and then **[F1]**.

At this point, the engagement can vary according to how the JTAC designates the target: Coordinate, smoke, or IR pointer. We'll discuss each of these separately:

Coordinate Only Designation:

When the JTAC does not have line of sight to the target (often the case with Type 2 and 3), it will only be able to designate the target as a MGRS coordinate.

After receiving the point data, the JTAC will clear you to engage.

After your attack is complete, press **[N]** or **[RALT + N]** and press **[F1]** "Attack Complete".

Smoke Designation:

After receiving the point data, the JTAC will ask you to report when you are IP inbound. When you are ready to proceed from the IP to the target, press **[N]** or **[RALT + N]** and **[F1]** "IP Inbound" to start your attack. If you are inbound from the IP, the JTAC will then tell you to continue.

At this point, you need to wait for the JTAC to mark the target with smoke. When you are within 10 nm of the target, the target will be marked with white smoke and the JTAC will radio that the "mark is on the deck". Once you have a visual on the smoke, press **[N]** or **[RALT + N]** and then **[F1]** "Contact the mark". The JTAC will then radio back the location of the target from the smoke marker.

Once heading toward the target, press **[N]** or **[RALT + N]** and then **[F1]** "In" to indicate that you've started your attack run. If all looks good to the JTAC, he will clear you in hot. If not, he will abort the attack. Once you have released your weapon, press **[N]** or **[RALT + N]** and then **[F1]** "Off".

Depending on the results of your attack, you will either be cleared to re-attack or cleared to depart. If cleared to re-attack, you need to start the process again from the IP Inbound stage of the attack.

IR Pointer Designation:

The IR Pointer, or IR Wand, replaces the smoke marker during low light conditions. To see the IR Pointer, you must have the Night Vision Goggles (NVG) on. The IR pointer appears as a line between the JTAC and the target.

As such, the process flow for the IR Pointer is the same as for the smoke marker. The only difference are the options for "Pulse" and "Rope" that instruct the JTAC to flash the IR Pointer on and off or move it around, respectively.

Other JTAC Radio Options:

During a JTAC directed attack, the JTAC menus allow some additional options not mentioned above. These include:

Repeat Brief. JTAC will repeat the 9-line briefing.

What is my target? JTAC will repeat the type of target that you are tasked to destroy.

Contact. This command is made to the JTAC to verify that the correct target is at the target location. You will report contact and provide a target description and MGRS coordinates. The JTAC will respond with a positive acknowledgment or with warning about contacting the wrong target. In its response, the JTAC also provide directions to the correct target.

Request BDA. JTAC will update you on the status of the directed target.

Unable to comply. Informs the JTAC that you are unable to carry out the instructed task.

Check Out. Ends JTAC control.

F5 ATC

The Air Traffic Control (ATC) system of this simulation is context sensitive to the location of your aircraft: on the parking ramp or runway/airborne.

ATC VHF FM Contact Frequencies:

Anapa-Vityazevo: 121.0 MHz

Batumi: 131.0 MHz

Gelendzhik: 126.0 MHz

Gudauta: 130.0 MHz

Kobuleti: 133.0 MHz

Kopitnari: 134.0 MHz

Krasnodar Center: 122.0 MHz

Krasnodar-Pashkovsky: 128.0 MHz

Krymsk: 124.0 MHz

Maykop-Khanskaya: 125.0 MHz

Mineralnye Vody: 135.0 MHz

Mozdok: 137.0 MHz

Nalchik: 136.0 MHz

Novorossiysk: 123.0 MHz

Senaki-Kolkhi: 132.0 MHz

Sochi-Adler: 127.0 MHz

Soganlug: 139.0 MHz

Sukhumi-Babushara: 129.0 MHz

Tbilisi-Lochini: 138.0 MHz

Vaziani: 140.0 MHz

Beslan: 141.0 MHz

Because the SCR-522A VHF AM radio of the P-47D is limited to 5 channels, you will only be able to communicate with those entities whose frequencies are loaded in your radio. Radio frequencies are loaded in the mission editor by the mission designer and should be made available as part of the mission briefing.

Parking Ramp Start

Before you can communicate with ATC/Ground Control to get permission to start your engine, you first need to have your VHF AM radio up and running.

With the radio now operating, press **[N]** or **[RALT + N]** to bring up the radio menu and then press F1 "Request Engine Start".

If you have wingmen, they will also now start their engine.

After the aircraft has been started and configured, select **[F1]** "Request taxi to runway". Once you receive permission, you can taxi to the "hold short" area of the taxiway - the area on the taxiway just short of entering the runway.

If you have wingmen, they will also now taxi to the runway.

When at the hold short area, press **[N]** or **[RALT + N]** and **[F1]** "Request takeoff". When permission is granted, you can taxi on to the runway and take off.

Runway and Air Start

If you are not starting from the parking ramp, you can access ATC by pressing the **[N]** or **[RALT + N]** key. Upon doing so, you can select **[F5]** "ATCs".

If you are using "Easy Communications", a list of airfields ATCs are listed along with their contact frequencies. Select the airfield ATC you wish to contact. If not using Easy Communications, you will first need to the push channel button of the assigned ATC frequency you wish to land on the radio.

Once the airfield ATC is selected, you can either send them an "Inbound" message to indicate that you intend to land there, or an "I'm lost" message that will result in the ATC providing you guidance to reach the airfield.

When you select "Inbound", the ATC will respond with the following information:

- Heading to fly to reach landing initial point.
- Range to landing initial point.
- The QFE, or atmospheric pressure at the airfield elevation.
- Which runway to land on.

You can then radio:

- "Request landing" indicates your intent to land at directed runway.
- "Abort landing" indicates that you will not be landing at the directed runway.
- "Request azimuth" requests navigation assistance to reach the airfield.

If you've requested landing and are on final approach, radio request landing a second time and ATC tower control will provide permission if the runway is clear. It will also provide wind direction and speed.

After you have landed, proceed to the parking area and shut down the aircraft.

F7 AWACS

After selecting the F7 AWACS option from the main radio menu, a list of all friendly AWACS in the mission will be listed, along with their VHF AM contact frequencies. Upon setting your VHF AM radio accordingly and contacting the desired AWACS, you'll be given the following options:

F1. Vector to bullseye. Sending this request to AWACS will result in AWACS providing you heading and range to the bullseye/anchor point set for the mission.

F2. Vector to home plate. Sending this request to AWACS will result in AWACS providing you heading, range, and the ATC frequency of the mission specified landing airbase.

F4. Request bogey dope. AWACS will provide heading, altitude, and aspect of the nearest enemy aircraft.

F5. Request Picture. Sending this request to AWACS will result in AWACS providing you bearing, range, and altitude of known enemy air threats.

The AWACS response differs according to the range of enemy air groups:

- **If BULL (over 50 nm):** (Your flight's callsign), (AWACS callsign), new picture, <number of groups detected> groups. First group, bulls <bearing> for <range>, <altitude band>. Second group, bulls <bearing> for <range>, <altitude>. (repeats up to three groups)
- **If BRA (under 50 nm):** (Your flight's callsign), (AWACS callsign), new picture, <number of groups detected> groups. First group, bra <bearing> for <range>, hits <altitude band>. Second group, bra <bearing> for <range>, hits <altitude band>. (repeats up to three groups)

F8 Ground Crew

After landing at a friendly airfield and taxiing to a parking ramp, you can communicate with the ground crew for rearming and refueling by pressing the F8 option to display the ground crew menu.

SUPPLEMENTS



SUPPLEMENTS

Airbase Data

Airbase	Runway	TACAN, channel	ILS	Tower comm
UG23 Gudauta - Bambara (Abkhazia)	15-33, 2500m			130.0
UG24 Tbilisi - Soganlug (Georgia)	14-32, 2400m			139.0
UG27 Vaziani (Georgia)	14-32, 2500m	22X (VAS)	108.75	140.0
UG5X Kobuleti (Georgia)	07-25, 2400m	67X (KBL)	07 ILS - 111.5	133.0
UGKO Kutaisi - Kopitnari (Georgia)	08-26, 2500m	44X (KTS)	08 ILS - 109.75	134.0
UGKS Senaki - Kolkhi (Georgia)	09-27, 2400m	31X (TSK)	09 ILS - 108.9	132.0
UGSB Batumi (Georgia)	13-31, 2400m	16X (BTM)	13 ILS - 110.3	131.0
UGSS Sukhumi - Babushara (Abkhazia)	12-30, 2500m			129.0
UGTB Tbilisi - Lochini (Georgia)	13-31, 3000m		13 ILS - 110.3 31 ILS - 108.9	138.0
URKA Anapa - Vityazevo (Russia)	04-22, 2900m			121.0
URKG Gelendzhik (Russia)	04-22, 1800m			126.0
URKH Maykop - Khanskaya (Russia)	04-22, 3200m			125.0
URKI Krasnodar - Center (Russia)	09-27, 2500m			122.0
URKK Krasnodar - Pashkovsky (Russia)	05-23, 3100m			128.0
URKN Novorossiysk (Russia)	04-22, 1780m			123.0
URKW Krymsk (Russia)	04-22, 2600m			124.0
URMM Mineralnye Vody (Russia)	12-30, 3900m		12 ILS - 111.7 30 ILS - 109.3	135.0
URMN Nalchik (Russia)	06-24, 2300m		24 ILS - 110.5	136.0
URMO Beslan (Russia)	10-28, 3000m		10 ILS - 110.5	141.0
URSS Sochi - Adler (Russia)	06-24, 3100m		06 ILS - 111.1	127.0
XRMF Mozdok (Russia)	08-27, 3100m			137.0

Morse Code Alphabet

Morse code	Alphabet	
	Russian	Latin
• - -	А а	A a
- • • •	Б б	B b
• - - -	В в	W w
- - •	Г г	G g
- • •	Д д	D d

•	Е е	E e
•••–	Ж ж	V v
–•••	З з	Z z
••	И и	I i
–•–	К к	K k
•–••	Л л	L l
––	М м	M m
–•	Н н	N n
–––	О о	O o
•–••	П п	P p
•••	Р р	R r
••••	С с	S s
–	Т т	T t
••–	У у	U u
••–•	Ф ф	F f
••••	Х х	H h
–•–•	Ц ц	C c
–––•	Ч ч	O o
––––	Ш ш	Ch ch
–••–	Щ щ	Q q
–•––	Ы ы	Y y
••––	Ю ю	U u
•–•–	Я я	A a
•–––	Й й	J j
–••–	Ь ь	X x
••–••	Э э	E e

Morse code	Digits full
•––––	1
••–––	2

•••--	3
••••-	4
•••••	5
-••••	6
--•••	7
---••	8
----•	9
-----	0
Morse code	Digits brief
•-	1
••-	2
•••-	3
••••-	4
•••••	5
-••••	6
-•••	7
-••	8
-•	9
-	0

Morse code	Punctuation marks
•-•-•-	Full stop / Period (.)
-•-•-•	Semicolon (;)
---•••	Colon (:)
•• •• ••	Point / Decimal separator (.)
••-•-••	Question mark (?)
•-••-•	Quotation mark ("")
--••--	Comma (,)
-•-•-•	Open parenthesis (()
-•-•-•	Close parenthesis ())

Sources

- "War in the air" № 46.
- Gennadiy Kornuhin. 50 best fighters of the World War II.
- Ivan Malyshev. Republic P-47 Thunderbolt.
- The Republic P 47D Тандерболт [Aircraft Profile 7].
- Planes of the World. Historical series. P-47 "Thunderbolt".
- FAQs.org.Greg Goebel.Air Vectors. The Republic P-47 Thunderbolt
- Joe Baugher. Encyclopedia of American Military Aircraft. Republic P-47 Thunderbolt
- William Green, Gordon Swanborough. The Complete Book of Fighter
- Jane's Fighting Aircraft of World War II
- Sebastien Guillemin. P-47 Thunderbolt
- Bert Kinzey. P-47 Thunderbolt in detail & scale
- FAoW. Richard I. Caruana. P-47 Thunderbolt
- Squadron & Signal. Larry Davis. P-47 Thunderbolt in Action
- Kagero. Tomasz Szlagor, Krzysztof Janowicz. Republic P-47 Thunderbolt
- MBI. Martin Velek, Valerij Roman. Republic P-47 Thunderbolt
- "World aviation", №41
- WarbirdTech. Frederick A. Johnsen. Republic P-47 Thunderbolt
- Monografie Lotnicze. A. Jarski, R.Michulec. P-47 Thunderbolt

Eagle Dynamics

Executive Board

Nick Grey

Project Head, Director of The Fighter Collection

Igor Tishin

Director of Eagle Dynamics (Russia)

Katarina Perederko

Director of Eagle Dynamics (Russia)

Sergei Gerasev

Project Manager

Andrei Chizh

Development Assistant & QA Manager, Producer,
Technical Documentation

Matt «Wags» Wagner

Producer, Game and Technical Documentation, Game
Design

Matthias «Groove» Techmanski

Localization Manager

Programmers

Alexander Oykin

Senior Programmer

Roman «Made Dragon» Deniskin

Aircraft Settings, Aircraft Systems and Flight Models

Dmitry «Yo-Yo» Moskalenko

Mathematical Models: Dynamics, Systems, and Ballistics

Maksim Zelensky

Aircraft, Aircraft AI, Flight and Damage Models

Dmitry Baikov

Systems, Multiplayer, Sound Engine

Designers

Pavel «DGambo» Sidorov

Lead Designer

Yuriy Starov

Aircraft 3D model

Gleb Sivtsov

Cockpit 3D model

Alexander «Skylark» Drannikov

GUI, Graphics, Aircraft

Sound

Konstantin «btd» Kuznetsov Sound director, composer

Quality Control

Valery «USSR_Rik» Khomenok Lead tester

Alexander «BillyCrusher» Biliyevsky Tester

Localization

Vasyl «ICS_Vortex» Komarichin Pilot's manual (Russian and English)

Vadim «VR» Repin Localization

IT and Customer Support

Konstantin «Const» Borovik Systems and Network Administrator, Web and Forums

Andrey Filin Systems and Network Administrator, Customer Support

Konstantin «MotorEAST» Kharin Customer Support

Special thanks to all participants of the P-47D beta test!

Sponsors

Bronze Sponsors

Kevin M. (tf_Stryker)	Alan_Grey	Allan Renwick	Andrew Webb
Thomas Guiry (tf_t4trouble)	Alberto Ceballos	Allen Thomas	Andrey Dvornik
Joonas (tf_Wraithweave)	Alberto Loro	alon oded	Andrey Loboda
[3rd]KaTZe	ALBERTO MARTIN	Alper Mat	Andrey ScorpyX
Shkval	SANTOS	Alvio Costantini	andrey112
=DRACO=	Alberto Minardi	ami7b5	Andrii
315_Piotras	Alcaudon101	Amir Lavi	Andy Cannell
a_korolev[at]pochta.ru	Alejandro	Ammo Goetsch	Andy Davidoff
Aapef	Alejandro Montero	Amos Giesbrecht	Andy McIntyre
Aaron Fess	Aleksander Yatsenko	Amraam	Andy Toropkin
Aaron Pratt	Aleksandr Kochelae	Anatoly Yakubov	Andy Wall
Aaron Sotto	Alekseev Valentin	Andre Schulze	Andy Wishart
Aaron Taylor	Aleksei Ivanov	Andre van Schaik	AndyJWest
AaronAsh	Aleksey Vlasov	Andreas Bech	Angel Francisco
Abc	Alex	Andreas Demlehner	Vizcaino Hernandez
Ace Rimmer	Alex	Andreas Macht	Angus MacQueen
Adam Chan Craig Martin	Alex Cameron	Andreas Monz	Angustumis
Adam Jasiewicz	Alex G	Andreas Pichler	Anjelus
Adam Navis	Alex Hitrov	Andreas Schmidt	Anonymous
Adam Schneider	Alex Huber	Andreas Tibud	Ant Paul
Adam Tomczynski	Alex Hughes	Andreas Wagner	Antal Bokor
Admir Nevesinjac	Alex Ip	AndreasDitte	Anthony
ADRIAN	Alex Murphy	Andrej Babis	Anthony Echavarria
Adrian Borodi	Alex Sabino	Andrej Jesenik	anthony milner
Adrian Cretu	Alex Turnpenny	andres garcia	Anthony Portier
Adrian Putz	Alex6511	Andrew	Anthony Smith
Aflay	Alexander	Andrew	Anthony Sommer
Aginor Chuain	ALEXANDER ALEKSEEV	Andrew Aldrich	Anthony Wheeler
Agnar Dahl	Alexander Barenberg	Andrew Bartlett	Antoine Taillon
Aidan Jabs	Alexander Borisov	Andrew Blinkin	Levesque
airyy[at]163.com	Alexander Gebhardt	Andrew Broadfoot	Anton Golubenko
Aivaras Staniulis	Alexander Orevkov	Andrew Dean	Anton Grasyuk
Aki Holopainen	Alexander Vasilyev	Andrew Deng	Anton Krug
Akin	Alexander Zhavoronkov	Andrew Devine	Anton Ottavi
Aksel Sandsmark	Alexandr Marishenkov	Andrew Fenn	antonello
Borgersen	Alexandr Petak	Andrew Garst	antonio dasilva
Aku Kotkavuo	Alexandre Jacquin	Andrew Gibbons	Antonio Manuel Ortiz
Aladrius	Alexandre Pigeon	Andrew Heimbuch	Seguel
Alain Gourio	Alexey	Andrew Hickman	Antonio Ordóñez de Paz
Alan Dougall	Alexey Ershov	Andrew Jennings	Antonyuk Dmitry
Alan Sharland	Alexey Polovets	Andrew MacPherson	Antti Kalliomäki
Alan Wade	Alexey_K	Andrew Olson	Antti Kauppinen
Alan Whitlock	AlexPX	Andrew Paull	Antvan
	ALFA_49	Andrew Rolfe	ANV
	Alfonso Garcia Martinez	Andrew Scarr	Anže Blatnik
	alfred demauro	Andrew Smith	Apex
	Alfredo Laredo	Andrew Stotzer	apollo01
	Alistair Stuart	Andrew Suhren	Aquila
	ALLAIN	Andrew Thomson	Aram
	Allan Chunn	Andrew Wagner	Aries The Destroyer

Arjuna	Bo Henriksen	bzan77[at]hotmail.com	Chris West
armrha[at]gmail.com	Bob Bent	Caldur	Chris Wuest
Arnel Hadzic	Bob Denhaar	Caleb E. Farris	Christelle JESTIN
Arto Rajajärvi	Bob Evans	Caleb Keen	Christer Arkemyr
Arto S.	Bob Petrone	callsignalpha	Christian
Arvid Weimar	Bob Radu	Cameron Fenton	Christian Biagi
Asier García	Bobby	Campbell McGill	Christian Bretz
Askauppinen	Bochkarev Leonid	captncrunch240	Christian Kistler
assaf miara	Bodhi Stone	Carl F Altrock	Christian Koller
AtreidesNL	Bogart Hall	Carl Jamz Chivers	Christian Koppe
Auez Zhanzakov	Bogdan Ghica	Carl Meyers	Christian Kreuter
Austin Mills	Bols Blue	Carlos Ferrer	Christian Mundt
avner rev	Borek Fanc	Carlos Siordia	Christian Pintatis
Azametric	Boris Schulz	Carsten Vogel	Christian R.
Balázs Lécz	borownjak	Catseye	Christian Reichel
Barry Colegrove	Borsch	Cecrops	Christian Richter
Barry Drake	BOSCHET	Cedric Girard	Christian Schwarz
Barry Matthew James	Bosko Djuric	Celso Lopez	Christian Taust
Barry Spencer	Brad Hawthorne	Cezariusz Czlapinski	Christoffer Wärnbring
barutan77	Brandano	Chad David	Christoph Gertzen
Basil Yong Wei Hee	Brant Templeton	Charles Burns	Christoph Mommer
Baytor	Branton James Elleman	Charles Conley	Christopher D.
beda	Brayden Materi	Charles Hill	Chambers
beikul	Brendan Clary	Charles Jesch	Christopher Hibberd
Ben Birch	Brenden Lake Musgrave	Charles M. Wilsenach	Christopher Lamb
Ben Green	Brendon	Charlie Brensinger	Christopher Miner
Ben Hollinsworth	Brendon McCarron	Charlie Glenn	Christopher Mosley
Ben Jarashow	Brent Wardell	Charmande	Christopher Phillips
Ben Rosenblum	Brett Goldsmith	Chaussette	Christopher Scarre
Benedict Hurkett	Brett Stengel	Chawin	Christopher Vance
Benjamin Böhm	Brian Carlton	cheap_truth	Chui Yin Ho
Benjamin Pannell	Brian Charles	Check Six	ciarano coyle
Benjamin Roser	Brian Fee	chedal-bornu sebastien	CiderPunk
benoit	Brian Kiser	ChenTing	Cikory
Beot	Brian Lanham	chev255	Claes Wiklund
Bernard McDavitt	Brian Lee Faul	Chezzers	clement epalle
Bernhard Dieber	brian mandeville	Ching-Ling Hsu	cliff clark
Berno	Brian Phillip Colella	CHO SUNG BAE	Cliff Dover
Bertrand Heurtefeu	Brillet Thomas	Chris	Cliqist.com
bichindaritz	Broodwich	Chris Abele	Cody John Davis
Bieringa	Bruce	Chris Benson	Colin Coulter
BIGNON	Bruce M Walker	chris birkett	Colin Inman
BigOHenry	Bruno Barata	Chris Ellis	Colin Muir
Bill	Bryan Nogues	Chris Engel	colin scutt
Bill Poindexter	Bryce Johnson	Chris H. Hansen	Collin Brady
Bjørn Inge Sørdermann	Bryce Whitlock	Chris Madera	Colonel Skills
blackjack04	Bryn Oliva-Knight	Chris Miller	Connor
Blackmind	bupbup	chris payne	Connor
Blarney DCS	Burgin Howdeshell	Chris Thain	Conor Bradley
Bloom	Buzzles	Chris Weerts	Conrad Lawrence

coriolinus	David Catley	Detlev Mahlo	Eric Howe
Cory Parks	David Cavanagh	Dharma Bellamkonda	Eric Lichtle
COUSSON	David Digholm	Dimitri Apostola	Eric Turner
Craig	David DuBois	Dimitrios Vassilopoulos	Eric Young
craig sweetman	David Dunthorn	Dmitry Khonin	Erik
Crimea_MULTI	David Egerstad	Dmitry Schedrin	Erik Dahlbäck
Cristian Marentis	David Endacott	DMS	Erik Schanssema
Csaba Moharos	David FreesAndrew	Doblejorge	Erik Suring
Curtis	McCann	Dominic Hildebrandt	Erik Weeks
cv	David Friend	Dominic Wirth	Etienne Brien
D McBain	David Gray Castiella	Dominik N.	Eugene Flannery
D P R MORRIS	David Gregory	Dominik Schulz	Eun-Tae Jeong
dahitman	David Grundmann	Don Menary	Evan McDowell
DailyDozo	David Irving	Don_Dragon	evgeniy
daisuke sato	David Mann	donald dewulf	Evgeniy
Dakpilot	David Miles	Douglas Ally	Evgeniy Troitskiy
Dale Jensen	David Moore	Drovek	Evgeny_RnD
Dale Winger	David Morrell	Duane Kennard	Eyal Haim
Dalminar	David Ordóñez	DUPONT Philippe	eyal shamir-lurie
Dan Antonescu	David Pajnic	Duroyon	f0uiz
Dan Lake	DAVID R COLEY	Dver	Fabian Wiesner
Dan Padnos	David Rilstone	EAF51_Luft	Fabiano Carlos Alves do
Daniel	David Ross Smith	EAF51_Walty	Nascimento
Daniel Beltran Gonzalez	David Savina	EagleTigerSix	Falcon5.NL
Daniel Boontje	david say	Eamonn McArdle	Federico Delfanti
Daniel Gestl	David Schroeder	Ed Curtis	Fedorenko Oleg
Daniel Groll	David Setchell	Edward A. Dawrs	fedorlev90[at]gmail.co
Daniel Holst	David Southall	Edward Billington-Cliff	m
Daniel Lewis	David Stewart	Edwin Szekely	Felix Felixsson
Daniel O'Sullivan	David Stiller	Edwin van Walraven	felix heine
Daniel Rozemberg	David Taylor	Eee3	Felix Mueller
Daniel Webb	David Terry	Egor Melnikoff	Fernando Becker
Daniil	David Tydeman	Eivind Tollerød Fosse	FERNANDO GARCIA
Danilo Perin	David Whitehead	Eli Havivi	RABADAN
Danny Vanvelthoven	Davidov Vitaliy	emanuele garofalo	FERNANDO MARTINEZ
Darcy Mead	Deadman	Emil Novák	ZAMBRANO
Darrell Swoap	Dean	Emilio Londono	Festari Diego
Darren Furlong	Deascii	Emir Halilovic	FF1
Daryl	Décio Fernandes Neto	Emmanuel Tabarly	FFalcon
Daryll Chupp	Declerieux	Enrico Zschorn	Field Manar
Dave Pettit	Demon	Enrique Alonso Benítez	Filip Kraus
Dave Webster	Denis Kaplin	Enrique Alvarado	Flex1024
David	Denis P	Eoghan Curtin	Florian Gehrke
David	Denis Winters	Erastos	Florian Voß
David Abreu	Dennis Ejstrup	Erdem Ucarkus	Flying Colander
David Belvin	Derek Barnes	Eric	folomeshkin[at]gmail.co
David Bray	Derek Guiliano	Eric Anderson	m
David Campbell	Derek Hatfield	Eric Dickerson	Force_Majeure
DAVID CARLISLE	Derinahon	Eric Fath-Kolmes	Ford Wesner
David Carter	DERRICK HILLIKER	Eric Gross	Francesco Kasta

Francisco Antonio	Gerald Jarreau	hansentf	Igor Bayborodov
Muñoz rodríguez	Gerhard Neubauer	HansHansen	Igor Kharlukov
Francisco Bercianos	German	harinalex	Iliia
Francisco José	Gert Wijbrans	Harkman	Ilja Osovin
Franciscus Berben	Gestl Guenther	Hasanka Ranasinghe	Ilya Feldshteyn
Frank Bußmann	Gianluca Giorgi	Hasse Karlsson	Ilya Golovach
Frank Hellberg	Giedrius Balynas	Havner	ILYA GRYZANOV
Frank Kreuk	Giovanni Anthony	HAYEZ JF	Ilya Kirillov
Frank Schwerdel	Bryden Jr.	hdbam	Imoel
Frank Townsend	Giovanni Degani	Heikki Moisio	Imrahil09
Fraser Reid	gkohl	Heillon	Ingo Ruhnke
Fred de Jong	Gleb Ivanovsky	Helio Wakasugui	Isaac Titcomb
Fred Golden	Glen Reed	Helldiver	Isidro Rios
Fred Schuit	Glenn Lilley	HellToupee	ismailaytekarlan[at]gm
Frederic GEDEON	Goat Yoda	Hemul	ail.com
Fredrik Silfverduk	gor7811[at]hotmail.com	Hen Shukrun	Istvan Takacs
Fredrik Sjöborg	Goran Skoko	Hendrik Berger	Ivan
Friedrich Plank	Göran Wikman	Henning	Ivan Čavlek
FSXFlight	Gordon McSephney	Henning Leister	Ivan Fedotov
Gabe Garcia	gordon vembu	Henning Leister	Ivan Kolincak
Gabor Buzasi	Graeme Hindshaw	Henri Häkkinen	Ivan_st
Gabriel Glachant	Grant Marchant	Henric Ceder	ivdadelbul
Gabriel Rosa e Silva	graylobo	Henrik Friberg	Ivica Milovan
Gabriel Venegas	Greg	Henrik Stavnsjoj	J.D. Cohen
Gabriel Vigil	Greg Bell	Hideki Mori	Jacek Karle
gabsz84	Gregg Cleland	Holger Reuter	Jack
Gareth Morris	GREGOIRE	Home Fries	Jack Beck
Gareth Williams	Gregory Choubana	Honza Lehky	Jack Noe
Garrett	Gregory D. Olson	HR_colibri	Jack Wilson
Garrett Longtin	Gregory Finley	Hrvoje Hegedusic	Jacob Babor
Garry Goodwin	Gregory Morris	Hrvoje Topličanec	Jacob Ellis
Gary Dills	Gregory Prichard	Huber Werner	Jacob Holmgren
gary doiron	Grigori Rang	Hugh Man	Jacob Knee
Gary Edwards	groovy	Hugo Saint Martin	Jacob Røed
Gary F. Tinschert	Groth	HUNTER	Jacob Shaw
Gary Lisney	Grzegorz Sikora	Hypothraxer	Jacob Williams
Gavin	Guido Bartolucci	Ian Bishop	Jacobo Rodriguez
gavin clunie	Guilherme Domene	Ian caesar	Jacques O'Connell
Gavin Crosbie	Guillaume Couvez	Ian Cockburn	Jakub Komarek
Gene Bivol	Guillaume Houdayer	ian d	James Cleeter
Geoffrey Lessel	GUMAR	Ian Dahlke	James D Brown
Geofray	gunter113[at]yandex.ru	Ian Hughes	James dietz
George Bellos	Gunther Mueller	Ian Jones	James Faraca
George Levin	Gustaf Engelbrektsen	Ian Marriott	James Franklin Lassiter
George Ölund	Gwyn Andrews	Ian Persson	James Freer
George Succar	Ha Za	Ian Rademacher	James Goodwin
George Xu	Hagan Koopman	Ian Smuck	James Harrison
Georgy	Hagleboz	Ian Taylor	James Jones
Gera	hangar16	Ian Todd	James Monson
Gerald Gassenbauer	Hans Liebherr	Ignacio Mastro Martinez	James Nielsen

James Pyne	Jefferson Santos	John Burgess	Joshua Fowler
James Russell	Jeffrey Gumbleton	John Dixon	Joshua Gross
James Smith	Jenei Béla	John Flain	Joshua Kozodoy
James Stephen	jens bier	John Huff	Joshua McQuinn Cook
James William Read	Jens Langanke	John J Tasker	Joshua Miller
jameson	jensl	John J.	Joshua Smith
Jan Baßfeld	Jera Oražem	John Johnson	Josse Aertssen
Jan Beissner	Jeremy Bartos	John Mathews	Josselin BEAU
Jan Ctrnacty	Jeremy David Keelin	John McWilliams	Jouvet Laurent
Jan Jaap Schreur	Jeremy David Tribe	John Phelps	jrbatche
Jan Kees Blom	Jeremy Gates	John Small	Juan Carlos Morote
Ján Pitor	Jeremy Lambert	John Smalley	Martin
Jan-Erik Saxevall	Jeremy Louden	John Trimble	juan enrique jurado
Jani Markus Laine	Jeremy Zeiber DCS	Jon H	mateu
Jani Petteri Hyvärinen	Jimbox	Jon Sigurd Bersvendsen	Juan Francisco Orenes
JanP	Jermin Hu	Jon webster	juan jose vegas repiso
Janus Sommer	Jernej Dolinsek	Jonas Weselake-George	Juan Rodriguez
jaosn	Jerry Brown	Jonathan Howe	Juan Soler Huete
Jarad Clement	Jerzy Kasprzycki	Jonathan Marsh	Juanfra Valero
Jared Fast	jesus gonzalez	Jonathan Mulhall	JUERGEN
Jared Macon	JetBane	Jonathan Rolfe	Juergen Dorn
Jared Thomas	Jether Pontes	Jonathen Iny	Juha Hayashi
Jared Winebarger	Jhusdhui	Jonathon Walter	Juha Liukkonen
Jaron Taylor	jim alfredsen`	Joona Järviö	Jukka Blomberg
Jaroslav Zahorec	Jim Allison	Joona Ruokokoski	Jukka Karppinen
Jarosław Tomaszewski	Jim Arentz	Joona V	Julian C Oates Jr
Jarrad Piper	Jim Barrows	Joonas Savolainen	Julian Gaffney
Jarred Nation	Jim Herring	Joonwook Park	Julien Godard
Jarret Mounteney	Jim Oxley	Jordan Cunningham	Julio Cesar Cardoso
Jarrold Ruchel	Jing Wang	Jordan Leidner	Jürgen Bischoff
Jason	Jip sloop	Jordan Moss	Jürgen Klein
Jason Chang	Jochen Baur	Jordan Pelovitz	Justin Smithson
Jason Cotting	Jochen Hamann	Jordi Haro	K. Loo
Jason Michl	Joe Prazak	Jorge Manuel Caravaca	k05
Jason Perry	joe troiber	Vidal	Kael Russell
Jason Robe	Joel Anthony	Jørgen Tietze	Kai Törmänen
Jason Smith	Pałaszewski Rydén	Jose Angel Gomez	kamaz
Javier Díaz Ariza	Joel Cuéllar	jose cruz	kamek25
javierlarrosa	Joel Rainsley	JOSE LUIS NOGALES	Kåre Kristian Amundsen
Jazz_35	Joen	CABALLO	Kareem Vafin
Jazzerman	Johan Lind	Jose Manuel	Karel Perutka
Jean Charles Baudry	Johan Waldemarsson	Jose Marrero	Karen Kurpiewski
jean-baptiste mouillet	Johannes Jaskolla	Josef Eberl	Kari Suominen
Jean-christian Ayena	Johannes Mueller-	Joseph Geraghty	Karl "Light" Akkerman
Andrea Cavalli	Roemer	Joseph Noe	Karl Bertling
JeepRazdor	John	Joseph Piasecki	karl bullard
Jeff Dodson	John A. Edwards	Joseph W Scupski	Karst van der Ploeg
Jeff McCampbell	John A. Turner	Josh lee	Karsten
Jeff Petre	John Boardman	Josh McLloyd	Karsten May
Jeff Zhou	John Brantuk	Joshua	kcstokes

Keijo Ruotsalainen	Kristofer Crecco	Luis Manuel Carrasco	Mark Fisher
Keith Bedford	krms83[at]gmail.com	Buiza	Mark Gordon Cochrane
Keith Ellis	Krueger	Luis Miguel Lopes	Mark Hickey
Keith Hitchings	Kruglik Svetlana	Lukas Erlacher	Mark Jedrzejczak
Keith Mercer	Krzysztof Nycz	Lukas Vok	Mark Linnemann
KeithKar	KS	Luke Campbell	Mark Lovell
Kempleja	Kurt Reimann	Luke Griffin	Mark McCool Jr
Ken Cleary	Kusch	Luke Lewandowski	Mark Nowotarski
Ken Holbert	KuVaNi	M Morrison	mark poole
Ken Peterson	Kyle	M. Zychon	Mark Sewell
kenneth	Kyle Fulton	Maarten Schild	Mark Shepheard
Kenneth Bear	Kyle Hannah	Magjstr	Mark Trenda
Kenneth Gustafsson	Kyle Knotts	Magnus Andersson	Mark Tuma
Kenneth Knudsen	kyle sinclair	Magnus Innvær	Mark Wallace
Kenneth P. Kaiser	L F Loxton	Mahler	MarkHawk
Kenneth Wong	LAI JINGWEN	Maik Baumert	Markus Berella
Kev	Larry Jones	Maik Dietz	Markus Bössinger
Kevin Beswick	Larry Lade	makabda	Markus Narweleit
Kevin Francis	Lars Lie	Makoto Hakozaki	Markus Nist
Kevin Watts	Lasse Nystuen Moen	malczar[at]wp.pl	Markus Ronkainen
Kevin Witt	Lasse-Pekka Toivanen	Manuel	Markus Wohlgenannt
Keyser	Lassi Miettunen	Manuel Maria Alfaro	marly fabien
Kieran Vella	Lasstmichdurch	Gomez	Martim Avelino Geller
Kilian Seemann	Laurent Cunin	Manuel Pace	Martin
Kim Ahlin	Lavi	Manuel Santiago Melon	Martin
Kim Fast	Lawrence Bailey	Guntin	martin costa
Kim Johnstuen Rokling	Leandro Medina de	MaP	Martin Durech
Kim Peck	Oliveira	Marc	Martin Eriya
Kimmo Eklund	Lefteris Christopoulos	Marc Heitler	Martin Handsley
Kirill Ravikovitch	Lenny Cutler	Marc Michault	Martin Hoffmann
Kirk Worley	Leon Grave	Marc-David Fuchs	Martin Kubani
KitSAllGoode	Leon Portman	Marcin Bielski	Martin Moráček
Kjell Saxevall	Leonard Burns	marco bellafante	Martin Ponce
Kjetil Lavik	Leonard Giesecker	marco meyendriesch	Martin Privoznik
Knut Erik Holte	Leonas Kontrimavicius	Marco Mossa	Martin Sanders
Kocso Janos	Leonid Dreyer	Marco Usai	Martin Seiffarth
Koh Desmond	Leszek Markowicz	marcos puebla	Martin Støyl
Koh Noel	Lewis Luciano	Marcus	Martin Thomas
kongxinga	Lhowon	Marcus Holm	Martyn Downs
Konstantin Borovik	Liam Williams	Marcus Koempel	Mate Majerik
Konstantin Dibrov	lighthaze	Marcus Schroeder	Matej Jelovcan
Konstantin Kharin	Lina Bigot	Marek Radozycki	matej renčelj
Koop de Grass	liweidaivid2006	Marijn Bos	Mathias Kallmert
Kornholio	Lluc Marquès	Marijn De Gussemme	Mathias Munkelt
KosiMazaki	Logan Lind	Mario Hartleb	Mathias Rüdiger
Kotaro Asada	LordLobo	Mario Mariotta	Matjaž Mirt
Koz Myk	Lorenzo Manzoni	Mark	Matt Berndt
kozeban[at]mail.ru	Louie Hallie	Mark David Cleminson	Matt Crawford
kpax	lowellsil	mark downer	Matt Fisher
Kristian Wall		Mark Duckett	Matt Huston

Matt Olney	Michael Miles	Mrgud	Novafiare
Matt Parkinson	Michael Olsen	msalama	nuclear
Matt Renfro	Michael Parsons	MTShelley	Nuno Silva
Matt Styles	Michael Petrarca	Muli Ivanir	Ofer Raz
Matthew	Michael Rezendes	Murilo Hound	OhioYankee
Matthew Dalessandro	Michael Rochon	Mustisthecat	Ola Nykvist
Matthew Deans	Michael Sprauve	Mytzu	Olaf Binder
Matthew Flanigan	michael tardio	Nacho	Oleg Antoshenko
Matthew Fortino	Michael Turner	Naglfar	Oleg Belenko
Matthew Hill	michael waite	NATALYA DOLZHENKO	Oleg Makarevich
Matthew Johnson	Michael Walker	Nathaniel Williams	Oliver Bennett
Matthew Kozachek	MichaelB	Nebuluz	Oliver Hooton
Matthew Lambert	Michal	Neeraj Sinha	Olivier Kozlowski
Matthew Lindley	Michał Gawroński	Neil Gardner	omar karmouh
Matthew Martin	Michal Krawczyk	Neil Vennard	opps
Matthew Morris	Michiel Erasmus	Neil Walker	Orion Robillard
Matthew Schneider	Michiel Jongenelen	Nestor Sanchez	Oscar Codan
Matthew Wohlford	Michiels Jorik	Neville Wakem	OSCAR LUIS GALVEZ
Matthias Kober	Mick Alden	Nicholas Bischof	CORTES
Matthias Lütke-Wenning	Miguel Angel González	Nicholas Prosser	Oscar Stewart
Matthijs	Domingo	Nicholas Wagner	Oskar Hansson
Mattia Garuti	Miguel Arias	Nick	outsorsing[at]yandex.ru
Mattressi	Miguel Coca	Nick Walsh	Owe Cronwall
Mátyás Martinecz	Mikael Harju	Nick Wright	P A KAFKAS
Maurice Hershberger	Mikal Shaikh	Nick Yudin	PA_Hector
Mauro Arguelles	Mike Bike	Nicklas Sjöqvist	Pablo Alvarez Doval
Max Michaelis	Mike L	Nico Heertjes	Pablo M Derqui
Max Taha	Mike Leviev	Nico Henke	Pablo Napoli
Maxim	Mike Schau	Nicola	Paganus
Maxim Gromada	Mike Theisen	Nicolae Buburuzan	Paolo Pomes
Mazin Ibrahim	Mike Williams	Nicolae Soanea	Paradox
Mehth	Mikko Esko	Nicolas Köhler	Pasbecq
MgFF	Mikko Härmeinen	Nicolas Piché	Pascal Fritzenwanker
Michael	Mikko Pulkkinen	Nicolas Rolland	pascual Miguel Gómez
michael	Mikplayeur	Niels Hille Ris Lambers	Martínez
Michael	Milan Simundža	Nigel Patrick Holmes	Pasi Yliuntinen
Michael Anson	Mircea Schneider	Niklas Nordgren	Patman DM
Michael Baldi	Miroslav Koleshev	Niko Huovilainen	Patrick Barnhill
Michael Barker	Miroslav Kure	Nikola Čeh	Patrick Naimo
Michael Ditter	Mitja Virant	Nikolaos Mamouzelos	Patrick Pfeleiderer
Michael Fielding	Mitja Zadavec	Nikolay	Patrik Lindström
Michael Gross	Modulus	Nils Hansen	Paul
Michael Grzybowski	Mod-World	Nir	Paul Brown
Michael Hart-Jones	MolotoK	Nir Bar	Paul Browning
Michael Jenneman	Momo Tombo	Noah N. Noah	Paul Cook
Michael Lajeunesse	Mor Rotholtz	NoOneNew	Paul Cookson
Michael Landshman	Moritz Brehmer	Norbert Röhrli	Paul Dyer
Michael Langness	mp	Norm Loewen	Paul Grint
Michael Long	Mr John C Smith	NoS	Paul Lucas
Michael Maddox	MrBoBo	Nosov Evgeniy	Paul Mikhail

Paul Miller	Pierre-Alain Séguier	Rickard Sjöberg	roman olenich
Paul Mulchek	Pierrick GUIRAL	Rico Reyes	Rommelius
Paul R Kempton III	Pieter Hofstra	Rincevent	Ron Lamb
Paul Savich	podvoxx	RJ Stevens	Ron Levy
Paul Sims	PopoidAndroid	RJW Scharroo	Ronnie Postma
Paul Thompson	Premysl Truksa	Rob Bywater	Ronny Karlsson
Paul Tricker	Przemek Ptasznik	Rob Umpleby	Rony Shtamler -
Paul Turner	Przemyslaw Cygański	Robert	IAF.RonyS
Paulius Saulėnas	quangorn	Robert	Ross Clunie
Pavel Bozhenkov	R. Thornhill	Robert Birnbaum	Ross David Hunter
Pavel Diachkov	Radosław Piątkowski	Robert Culshaw	Ross Francis
Pavel Osipov	Radu Gabriel BOIAN	Robert Curtin	Ross Goodman
Pavel Škoda	Rafal	Robert Dvorak	Ross Hamilton
Paweł Sokołowski	Rafał Szekalski	Robert Elliott	Ross Martin
PbICb	Rainer Schweers	Robert Haynes	ROSS_BerryMORE
pds21	Raj János	Robert M	ROSS_Borman
Peden Harley	Ralf Pitzer	Robert Mahon	Rudo Sintubin
Pedro	Rami Ahola	Robert Morris	Runar Aastad
Pekka	rami veiberman	Robert Nigel Jamison	Rune Hasvold
Per-Erik Linden	Ramsay Beshir	Robert Noke	rutkov
Pete Jockel	Randy Erwin	Robert Ormes	RvGils
Peter	Randy W. Boots	robert peterson	Ryan
Peter Baltzer Hansen	Raphael Willerding	Robert Roberge	Ryan Doppke
Peter Brooks	Raptor007	Robert Stuart	Ryan Heseltine
Peter Collins	Ratnikov Maksim	Robert Toldo	Ryan Peach
Peter Fischbach	Ray Dolinger	Robert Walters	Ryan Pourroy
Peter Halmy	Reece Heinlein	Robert Zuk	S4ndman
Peter Ivady	Reinhard Seitz	Roberto Carcano	Saad Eldeen Bahloul
Peter James Taylor	Rem	Roberto Elena	Sacha Ligthert
Peter Jensen	Remon	Roberto Mejia	saif ghadhban
Peter Orlemann	renderstop	Robin Harroun	Sakari Pesola
Peter Pühringer	Rene Buedinger	Robin Norbisrath	Sam "Mainstay"
Peter Schmecker	Rhandom	Robin Senkel	Valentine
Peter Svensson	rhinofilms	robin vincent	Sam Lion
Peter Wiklöf	ric	Rod Middleton	Sam Yeshanov
peter winship	Ricardo Madeira	Rodrigo Mejía	Sami Juntunen
Petter Lausund	Ricardo Nuñez	roemalis[at]gmail.com	Sami Luukkonen
PH	Richard	Roger Buchser	Samuel
Phil	Richard Baas	Roger Owen	Samuel Bera
Phil Barker	Richard Hickerson	Roger Ringstead	Samuel Morrissey
Phil Hawes	Richard Mater	ROGIER	Sándor Balikó
Philippe VINCENT	Richard McKeon	Roland Galfi	Sandra Walsh
Philippe-Olivier Dubé	Richard Orädd	Roland Peters	SATANA667
phill davies	Richard Whatley	Roland Reckel	Saxon66
philux	Richy	Roland Schulpen	Scott
Phoenix	rick andersen	Rolf Geuenich	Scott Daniels
PHOENIX Interactive	Rick Benua	rolf szcseny	Scott Eckrich
PhoenixPhart	Rick Dodge	Roller Donny	Scott Hackney
pierre burckle	Rick Keller	Romà	Scott Kullberg
Pierre Rieu	Rick Miles	Roman	Scott Newnham

Scott Willtrout	sotosev	SYN_Skydance	Tim Shaw
Scrub	Space Monkey	Tacno	Tim Shaw
Sean	Spencer Miller	TAIKI SONOBE	Tim Vlemminckx
Sean Colvin	Sputi	Takayuki	Timo Hiltunen
Sean G of the CoD	ssonniccc	Takku	Timo Vestama
Sean P. Burt	Steam	Tamir Katz	Timothy Bauer
Sean Taylor	Stefan Meier	Tang.Weii	Timur Kaziev
Sean Tudor	Steffen Link	Taproot	TinfoilHate
Sebastian	Stephan Gako	Tarasyuk Yuriy	tintifaxl
Sebastian Baszak	Stephan Kerkes	taratuta	Tioga
Sebastian Grant	Stephen Barrett	Teapot	tjmp14
Sebastian Hernandez	Stephen Botti	Tekray	Tobais Hassels
Sebastian Lindmark	Stephen Clark	Teodor Frost	Tobias
Sebastian Schöder	Stephen Higginbotham	Teppo	Tobias A
Seel	Stephen Howe	Tere Sammallahiti	Toby Rushton
Sergey	Stephen Lynn Flores	Terence Ziegler	Töfol Jordà Chordà
Sergey Mozheyko	Stephen Ryan	TerminalSaint	Tom
Sergey Nikishin	Stephen Wilson	TerribleOne	Tom
Sergii Gabal	sterfield	Terry	Tom G
Sergio	Steve	Terry Scott	Tom Gillespie
SERGIO OLIVEIRA	Steve	tessore	Tom Humplik
sfer314	Steve Barnes	Test	Tom Johnson
Shadow Stalker	Steve Boyd	Teun van Dingenen	Tom Shackell
Shai Lum	Steve Chatterton	The Shoveler	Tom Strand
Shane Sigley	Steve Colli	TheKhann	Tom Summers
Sharin Vladislav	Steve Cook	Thelmos	Tomas Friberg
Shawn Vowell	Steve Dozniak	Theo	Tomas Hridel
Shimon Okun	Steve Klinac	Theodoros Montesantos	Tomas Lindahl
shurke	steve lecount	thom burt	Tomas Munoz
Shuyang leung	Steve Mcnitt	Thomas Berg	Tomasz Karpiuk
Sideris Fotis	Steve Poirier	Thomas Beuleke	Tomasz Szulc
Sigurd andre olaisen	Steve Rizor	Thomas Fisher	Tomi Junnila
Silverado	steve smith	Thomas Harkless	Tomik
Simmy	Steven Adasczik	Thomas Hegman	Tommy Pettersson
Simon Aplin	Steven Bodenstab	Thomas LaGoe	Tommy Tomaszewski
Simon Briggs	steven connolly	Thomas Leitner	Tongp
Simon Harrison	Steven Myall	Thomas Lipscomb	Toni Talasma
Simon József	Steven Newbold	Thomas Mitchell	Toni Uusitalo
Simon Picken	Steven Rushworth	Thomas Nesse	Toni Wasama
Simulatu	Stoops417	Thomas Reynolds	Tony Baeza
Sita	Stuart Andrews	Thomas Schroeder	Tony Buman
Siv	Stuart Campbell	Thomas Weiss	tony lafferay
siva	Stuart Jarman	Tim	Torashuu
Skorak	Stuart Walton	Tim Hawkins	Torben Porsgaard
SlipBall	subject to change	Tim Huthsteiner	Torbjorn Pettersson
snagov	Susumu Takizawa	Tim Ireland	Tore Fagerheim
solo117[at]mail.ru	Sven G.	Tim Julkowski	Tore Torvik
SolomonKane	Sven R.	Tim Kelly	Tor-Martin Trollstøl
Sonia Holopainen	sydost	Tim Krieger	Torstein
SonixLegend	Sylwester Żuzga	Tim Rawlins	Torsten Schuchort

Torsten Writh	VIDAL Frank	Wyatt Moadus
trashcutter	Vieillefont Antoine	Yama
Trasric	Viktor Friesen	yanba109
Traz	Vilir	yendysl
Trevor Abney	Ville Vuorinen	yoel lavi
Trevor Burns	Vincent	yohay
Trevor Tice	Vincent	YoYo
Trindade	Vincent Eysel	Yuke kaito
Tripp	Vit Prokop	Yurii Nadeyin
Troy Nakauchi	Vitalii Podnos	Zach Brown
Truls Jacobsen	Vitor Pimentel	Zachary Layne
Tuan Nguyen	Vivoune	Zaghloul Othmane
Tuco Ramirez	Vladimir	zan.blatnik[at]hotmail.c
Tuomas Mämmelä	Vladimir Alexx	om
Tuomas Virtanen	Vladimir Domnin	Zeteyx
Tvrtko Kovacic	Vladimir Škorić	Zhou Lingshu
Tyler Krebs	Vladimir Švajda	Zhuravlev Pavel
Tyler Thompson	Vladimir Yelnikov	Zinoviy Khutoryan
UbiquitousUK	Vladislav Shkapenyuk	Zlatko Birtic
ugo cozza	Marek Picka	
Ulrich Haake	Volker Saß	
uncle_stranger[at]hotm	vukicevic sasa	
ail.com	Waide Tristram	
Uri Ben-Avraham	Waldemar	
UriiRus	Walrus	
Uros Karamarkovic	Wang Bin	
urvuy	Wang Kang Ping	
Useless	Warren Evans	
UsF	Wayne Dickinson	
Uwe Mueller	Wayne LeFevre	
V	weisse13	
Vadim Adel	Werner Ceelen	
Vadrin	Wes Snyder	
Valentin Loginov	Wesley Marcone	
Valeriy Nabatov	Simmer	
Varun Anipindi	WhiskeyBravo	
Vasco Charles Morais-	Wienerschnitzel	
Boulay	William J. Bryan Sr.	
vb12daduck	Willem Erasmus	
Veli-Matti Paasikivi	William Belmont	
vella	William Clark	
Vesa Slotte	William Deal	
Vespero	William Herron	
Viacheslav	william neil harding	
Vicente Herrera	William Plischke	
Victor "Dream Traveller"	William Stover	
Buttaro	William Wilson	
Victor Gil	Williame Laurent	
Victor Tumanov	Wonderbread	
Victor99	wuffman	

Silver Sponsors

Aaron Anderson
 Aaron Zmarzinski
 Adam
 Adam Elfström
 Adam Murray
 Adrian Havard
 airdoc
 AKuser99
 Alain Becam
 Alanthegreat
 Aleksey Kopysov
 Alex "Razorblade"
 Alex Pekarovsky
 Alexander Casanova
 Alexander Henriksson
 Alexander Vogel
 Alexandre Tellier Talbot
 Alexey Ibragimov
 Alexey Slavutskiy
 alfonso cordoba
 aguilera
 Alfredo Croci
 Allan Spears
 Allan Taylor
 Alon Tall
 Andres
 Andres Riaguas
 Andrew Brown
 Andrew Fudge
 andrew norgrove
 Andrew Payne
 Andrew Spanke
 Angel Morata
 Ante Turkovic
 Anthony Chant
 Anton Quiring
 Antonio Ruotolo
 ApeOfTheYear
 Arcady Chernavin
 Arrie
 Arthur Changry
 Arto Santasalo
 Ashley Bennett
 Ashley Ellis
 ATAG_Old_Canuck
 Austin
 Aviad Tobaly
 Axel Haake
 Axel Miedlig
 Axion
 baikal.68[at]mail.ru
 Barry Maunsell
 Bas Weijers
 Bastiaan Jansen
 Bearcat
 Benjamin de Rohan
 Benjamin Freidin
 Benjamin Frost
 Bennett Ring
 Berkes Attila
 Bjarne Stig Jensen
 Bjoern Wiederhold
 Blackwolf_927
 Blake Cetnar
 Boomerang
 Boris G
 Brad Ernst
 Brad Rushworth
 Braden Johel
 Bradford Julihn
 Brandt Ryan
 Brett Bodi
 Brian Kanen
 Brian Scott Pagel
 brimen
 Bruce Mackay
 Bruce Wilson
 Bryan Baldigowski
 Bucic
 Capgun
 Carl Lyles
 Carlos Garcia
 Chance
 chardon
 Charles Savas
 Charlie Orchard
 Chris C
 Chris Cantrell
 Chris H
 Chris Osterhues
 Chris Payne
 Chris Schultz
 Christian Gomolka
 Christoph Jaeger
 Christoph Jungmann
 Christoph N
 Christopher Ludgate
 Christopher Nee
 Christopher Ryan Kelley
 Cian Quigley
 Col Shaw
 Colin
 Colin McGinley
 Colin Rowland
 Conny Näslund
 Conrad Smith
 Cornay Sinac
 Cory Avery
 Craig Brierley
 Craig Gillies
 Crimson Machete
 Cuba80[at]t-online.de
 D. Reveal
 Dalton Miner
 Dan Randall
 Daniel Agorander
 Daniel Dillman
 Daniel Erlemeyer
 Daniel Marsh
 Daniel Vukmanich
 DanMe
 Danny Stevenson
 DarKcyde
 Darrell Herbert
 Daryl J. Lloyd
 Dave Farr
 Dave Kelly
 Dave Reichard
 David Challis
 David Craig
 David Froholt
 David Gibson
 David Horkoff
 David Levy
 David Maclean
 David McCallum
 David O'Reilly
 David Penney
 David Weaver
 davisballen
 DDB
 Dennis Camosy
 dennis worley
 desert eagle540
 Devin Ragsdale
 DJB
 Dominik Merk
 Doug Elliott
 Douglas Watson
 Dr. Stefan Petersen
 Drew Pedrick
 Drum_Tastic
 Duncan Hewitt
 Edin Kulelija
 Eduardo Gutiérrez
 García
 Edward Kiervin
 Edward Winsa
 Einar Oftebro
 Eldur
 Elfin
 Elliot Christian
 Emil Philip
 enrique colome
 Eponsky_bot
 Eric Keith Robinson
 Eric Koepp
 Eric Staton
 Erich Kreiner
 Erik Boogert
 Espen Hundvin
 Euan Arthur Emblin
 Evan Kosnik
 Evert Van Limbergen
 Falco
 Famin Viacheslav
 Fangqiu Zhu
 fedja
 Feldmann
 Felix Berchtold
 Flagrum
 Forest Faltus-Clark
 Fredrik Petersson
 Frenzy
 Frerk Schmidt
 g_nom21
 garengarch
 Gary
 Gary N. Peden
 Geoffery Jensen
 George Bonner
 George Inness
 George Neil
 Gerald Gong
 gerard o'dwyer
 Glen Murphy
 Glenn Pechacek
 Graham Smart

Graham Wilson	jcenzano	Karfai Michael Yau	Markus Sohlenkamp
greco bernardi	Jean-Pierre Weber	Karsten Borchers	Martin Gronwald
Greg Appleyard	Jeff Kerian	Keith Bumford	Martin Scholz
Greg Huffman	Jeffrey A Bannister	Keith Young	Martin Winter
Gregory Foran	Jeffrey Miller	Ken Biega	Mason Flake
Gustavo Halasi	Jeffrey Walsh	Kenneth Avner	Masset
Hammed Malik	Jens Kadenbach	Kenneth Sapp Jr.	Massimiliano bonin
Hannu Heino	jeremy	Kent-Ruben Elvestrand	Mathew Crane
Hansang Bae	Jeroen Gommans	Kestutis Zilys	Matt Engelhart
hansen	Jeroen Wedda	Kevin Clarke	Matt Lind
Hans-Joachim Marseille	Jerry Frost	Kevin Garrett	Matt Miller-Fewer
Hassel Krauss	Jesse Higdon	Kevin Reuter	Matthew D Qualls
Heinz-Joerg Puhlmann	Jez Brown	kevman	Matthew Enloe
Iain Colledge	jim crimmins	Khaydanov Yuriy	Matthew Horrigan
Ian Buckler	Jim Valentine	Kiefer Jones	Matthew Walker
Ian Kaiser	Jinder Greewal	Kirin	Matti Lund
Ian Keenan	Jiong Zhang	Kirk Lange	Mdep5809
ian leslie finlay	Joe Dionisio	Knut Hanssen	Mhondo
Ian Seckington	Joe Troiber	Korotky Vadim	Micha Tanny - a.k.a
Iffn	Joe Veazey	Kristian V Meyer	IAF_Phantom
Igor K.	Joel Docker	kurnz	michael
Iker ulloa	Joel Opdendries	kurt Weidner	Michael Benton
Insy	Johan Soderholm	Kyle Colyer	Michael C Ringler
Iran Fernandes de	Johan Törnholm	Kyle Rudnitski	Michael G Ribordy
Oliveira	John Hannan	Lanzalaco Salvatore	Michael Heron
Ishtmail	John Lynn	Lawrence Lester	Michael Illas
ivan decker	John Nespeco	Lawry Playle	Michael Jochim
Iván Pérez de Anta	John Pengelly	Leif Lind	Michael Riley
Jack Gurley	John Regan	lemercier cedric	Michael Rishel
Jacob Eiting	John Vargas	Leon Higley	Michael Smith
Jake O'Mahony	Jon Isaacs	Libor Stejskal	Michael Umland
Jakob Boedenauer	Jonathan Clarke	Ljas	Michal BIZON
Jamees Hancock	Jonathan Lim	Lunovus	Mike Frank
James Cook	Jonathon Kinnin	Maler	Mike O'Sullivan
James Cross	Jordan Forrest	Måns Gotare	mike richgruber
James F Miller	Jordan Marliave	Manuel Ramsaier	Mike Todd
James L. Rumizen	Jörgen Toll	MARCELO TAKASE	Mikko Laukkanen
James Phelan	Jorin Sheaffer	Marcelo Tocci Moreira	Mitchell Sahl
James Roy	Jose Luis Navarro Reus	Marco Landgraf	MK
James Schlichting	José Oltra Martínez	Marek Ratusznik	modernatomic
James Sterrett	Joseph Krueger	Mario von Thenen	Neil Merrett
jamie	Joshua Blanchard	Mark A. Kirkeby	Nicholas Landolfi
Jamie Denton	JST	Mark Clark	Nick
Janusz	Jukka Huhtiniemi	Mark Delahay	Nick Iassogna
Jared Sorensen	Jukka Rouhiainen	Mark Gaffney	Nick Murette
Jason Brown	Julian	Mark McRae	Nick Mowbray
Jason Deming	Julian Urquizu	Mark Siminowski	Nick Vamis
Jason Montleon	Juliano Simoes Haas	Mark Thorp	Nicolas Belanger
Jason Reynolds	Juris L Purins	Mark Watson	Nils Thiel
Jasper Hallis	Kaijev	Markus	Nurbol

Nyaro Laszlo-Carlo oat03001 Olaf Walter oldracoan Oliver Sommer Oliver Anstett Ori Pugatzky Otto Conde de Resende oyvindf11[at]gmail.com PakoAry Patrick O'Reilly Paul Adcock Paul Cucinotta Paul Elton paul green Paul Hughes Paul Walker pavlich pedro Pedro Mellado Penpen Peter Bartlam Peter Fortner Peter Krause Peter Reinhard Peter Scaminaci Peter Solbrig Peter Stephenson Polar Polaris Bluestar Pvt.SNAFU Qi Huo qmsan[at]yandex.ru Rae Ray Vine Ray West Rayvonn Core Reinhard Eichler Remco RF Richard Stinchcomb Rick Zhang Rob Brindley Robert Bähr Robert Cannon Robert Conley III Robert Holleman Robert Ian Charles Fellows robert kelly	Robert Schroeder Rodney Neace roman Roman Frozza Roman Kolesnikov Ron Brewster Ron Cassinelli Ronald Hunt Ross White Rouven Metzler Roy Woodworth Royraiden Runefox Russ Beye ryan brantly Ryan Denton Ryan Thomas Jaeger Ryan Yamada Sam Carlson Sam Wise San Mecit Erdonmez Sandalio Scott Beardmore Scott Fligum Scott Gorring Scott Heimmer Scott Withycombe Scott Woodbury Scruffy sdo sdpg_spad Sean Buchanan Sean Price Sean Walsh Sebastian Riebl Sebastien Clusiau Sébastien Vincent Seeker37 Sega Dreamcast Sergey Ravicovich Sergey Velikanov Shannon Craig Shaun Cameron Sheldon cannon Sherif Hosny Sigurd Hansen SimFreak Snowhand Sokolov Andrey Sonid Salissav	Sorin Secu Stanislav Sereda stefan bartram Stefan Bohn Stefan Jansen Stefan V Stephen Hulme Stephen M Zarvis Stephen Morrison Steve Gentile Steve Harmer Steve Ralston Steven Aldridge Stewart Forgie Takahito Kojima Tempered Thomas Cofield Thomas Dye Thomas Falmbigl Thomas Fuchs Thomas Ruck Thrud Tibor Kopca Tien Brian Tim Chapman Tim Collins Tim Hay Tim Mitchell Tim Morgan Tim Wopereis Timo Wallenius Timothy J. Burton Tino Costa Titus Ou tkmr Tobalt Tobias Kiedaisch Todd Bergquist Tom Bies Tom McGurk Tom Tyrell Tor Stokka Torsten Tramm Torsten Tramm Totoaero tough boy TrailBlazer TRESPASSER Trevor Tranchina Tyler Gladman	Tyler Moore Vaclav Danek Vaz Vendigo Victor Nakonechny Viktor Baksei Ville Ilkka Vit Premyslovsky Vit Zenisek W. Duncan Fraser Wade Chafe Wang Feng War4U Warmoor Wasserfall Wayne Adams Wayne Berge Wes West William Pellett William S. Ball William Skinner Yaniv Harel Ye91 Youngmok Rhyim Yukikaze Zappatime Zaxth - Weresheep of Sin
--	---	--	---

Gold Sponsors

AJD van der Valk	JiriDvorsky	Salvador
Akshay Tumber	Joakim Söderman	Scott
Alexander Vincent	Joan Sabater	Secret Squirrel
Andreas Bombe	Johannes Wex	Sergey Goretsky
Andrey	John McNally	Sergey Ipolitov
Antonio Salva Pareja	Joseph Anthony Elliott	Stanislav
Arno Hasnæs	Jostein Kolaas	Stephen Turner
auo74	Kaiser	Steve Butler
bounder	Karl Asseily	Steven Mullard
Brad Stewart	Karl Miller	Stewart Sayer
Buster Dee	Kevin Hürlimann	Sven Bolin
Carl Johnson	Kevin Vogel	Thomas Bakker
Carlos Henrique Arantes	klem	Tom Lewis
Theodoro	Laivynas	Tony Webber
Celtik	LP	Torian
charger-33	Luís Ferreira	Ulrik Svane
Christian Noetzi	Måns Serneke	William Forbes
Christopher Foote	Mario Binder	Zamaraev Anton
Christopher Ruse	Marius Backer	Vladislavovich
Daniel Clewett	Martin Heel	Zoltann
Dean Christopher	Martin Janik	
Fortomaris	Matt Skinner	
Dean Gardiner	Mattias Svensson	
desruels jean	Max dahmer	
Donald Burnette	Maxim Lysak	
DragonShadow	Michael Gaskell	
Drew Swenson	Michael Leslie	
Duncan Holland	Michal Slechta	
Erik Nielsen	Mikko Räsänen	
Fabian Kraus	Miquel Tomàs Homs	
Frank Zygor	Murray Thomas	
G W Aldous	Mysticpuma	
Gershon Portnoy	Nathan	
Goanna1	Nezu	
Greg Pugliese	Nicholas Sylvain-	
Gregory Daskos	Obsidian Tormentor	
Griffith Wheatley	Oliver Scharmann	
Håkan Jarnvall	Or Yaron	
Hans Heerkens	Peter Fritz	
Harry vandeputte	Phantom88	
HoperKH	Phil Rademacher	
Ian Grayden	Pier Giorgio Ometto	
Ian Linley	Pizzicato	
J.J. Wezenberg	Polaris Penguin	
JANIN Elie	Reinhard Zeller	
Jason Story	Richard Williams	
Jaws2002	Robert Shaw	
Jim Van Hoogevest	Robert Staats	
	Ron Harisch	
	Roy Enger	

Platinum Sponsors

=tito=

322Sqn_Dusty
 Aaron Kirsch
 Adam Del Giacco
 AirHog71
 Alexander Osaki
 Alexis Musgrave
 Alvin Pines
 AndK
 Andreas Gruber
 Andrew Gluck
 Aníbal Hernán Miranda
 Ariel Morillo
 Atle Fjell
 Bobby Moretti
 Brad Edwards
 Brian Thrun
 CAHUC Fabien
 Caulis Brier
 Chad Owens
 Charles Quellet
 Chekanschik
 Chivas
 Christian Knörndel
 Christoffer Ringdal
 David Block
 David Stubbs
 David Vigilante
 DavidRed
 dgagnon99
 Dieter
 Dimitrios
 Syrogiannopoulos
 Eric W Halvorson
 Ethan Peterson
 Federico Franceschi
 G W Aldous
 Geoff Stagg
 Grant MacDonald
 Harald Güttes
 Hen
 HolyGrail FxFactory
 Ian
 Ilkka Prusi
 Ilya Shevchenko
 Jim Magness

Johanán
 John Guidi
 JOSHUA C SNIPES
 KDN
 Kevin Gruber
 KLEPA
 Kodoss
 Krupi
 Les Hillis
 Luke Scalfati (tf_neuro)
 M. Carter
 MACADEMIC
 Martin Jaspers
 Melanie Henry
 michael addabbo
 Michael Brett
 Michael Vrieze
 Mike Abbott
 Mike Bell
 mike parsell
 Mike Williams
 Necroscope
 Nirvi
 Ole Jørgen Hegdal Lie
 Palmer T Olson
 Patrick
 Ralph Mahlmeister
 Rémy "Skuz974"
 STIEGLITZ
 Richard Ashurst
 Richard Boesen
 Richard Skinner
 Robert Cattaneo
 Ryan Power
 Ryohei Yoshizawa
 Sam Higton
 Sean Trestrail
 Shawn Godin
 Soeren Dalsgaard
 Stefano Dosso
 Stephen Ptaszek
 TC1589
 theoretic
 Tom Galloway
 Tom Lucky Klassen
 Trond Bergsagel
 William Denholm
 Zinj Guo

Diamond sponsors

Robert Sogomonian
Etienne Boucher
Ronald L Havens
Dave
John Bliss
Pers
JtD
Robert S. Randazzo
Simon Shaw
Don Glaser
David Baker
John Douglass
john
Steven John Broadley
Matt D
olegkrukov[at]inbox.ru
Panzertard
JtD
Robert S. Randazzo
graham cobban
John Wren
Pitti
Simon Shaw
Don Glaser
David Baker
John Douglass
john
Steven John Broadley
Matt D
olegkrukov[at]inbox.ru
Panzertard

© EAGLE DYNAMICS
2020